

# 2009 Cadillac XLR/XLR-V Owner Manual

---

<b>Seats and Restraint System</b> .....	1-1	<b>Instrument Panel</b> .....	3-1
Front Seats .....	1-2	Instrument Panel Overview .....	3-4
Safety Belts .....	1-6	Climate Controls .....	3-36
Child Restraints .....	1-23	Warning Lights, Gages, and Indicators .....	3-41
Airbag System .....	1-38	Driver Information Center (DIC) .....	3-57
Restraint System Check .....	1-52	Trip Computer .....	3-76
<b>Features and Controls</b> .....	2-1	Audio System(s) .....	3-76
Keys .....	2-3	<b>Navigation System</b> .....	4-1
Doors and Locks .....	2-10	Overview .....	4-2
Windows .....	2-17	Features and Controls .....	4-10
Theft-Deterrent Systems .....	2-20	Navigation Audio System .....	4-52
Starting and Operating Your Vehicle .....	2-24	Voice Recognition .....	4-74
Mirrors .....	2-38	<b>Driving Your Vehicle</b> .....	5-1
Object Detection Systems .....	2-40	Your Driving, the Road, and the Vehicle .....	5-2
OnStar <sup>®</sup> System .....	2-42	Towing .....	5-26
Universal Home Remote System .....	2-45		
Storage Areas .....	2-53		
Retractable Hardtop .....	2-54		

---

<b>Service and Appearance Care</b> .....	6-1	Vehicle Identification .....	6-81
Service .....	6-3	Electrical System .....	6-82
Fuel .....	6-5	Capacities and Specifications .....	6-90
Checking Things Under the Hood .....	6-10	<b>Maintenance Schedule</b> .....	7-1
Rear Axle .....	6-41	Maintenance Schedule .....	7-2
Headlamp Aiming .....	6-42	<b>Customer Assistance Information</b> .....	8-1
Bulb Replacement .....	6-45	Customer Assistance and Information .....	8-2
Windshield Replacement .....	6-45	Reporting Safety Defects .....	8-14
Windshield Wiper Blade Replacement .....	6-45	Vehicle Data Recording and Privacy .....	8-16
Tires .....	6-46	<b>Index</b> .....	1
Appearance Care .....	6-74		

---



GENERAL MOTORS, GM, the GM Emblem, CADILLAC, the CADILLAC Crest & Wreath, and the name XLR are registered trademarks, and the name XLR-V is a trademark of General Motors Corporation.

This manual includes the latest information at the time it was printed. GM reserves the right to make changes after that time without notice. For vehicles first sold in Canada, substitute the name "General Motors of Canada Limited" for Cadillac Motor Car Division wherever it appears in this manual.

This manual describes features that may or may not be on your specific vehicle.

Read this manual from beginning to end to learn about the vehicle's features and controls. Pictures, symbols, and words work together to explain vehicle operation.

Keep this manual in the vehicle for quick reference.

Litho in U.S.A.  
Part No. 25789008 A First Printing

## Canadian Owners

A French language copy of this manual can be obtained from your dealer/retailer or from:

Helm, Incorporated  
P.O. Box 07130  
Detroit, MI 48207  
1-800-551-4123  
helminc.com

## Propriétaires Canadiens

On peut obtenir un exemplaire de ce guide en français auprès de concessionnaire ou à l'adresse suivante:

Helm Incorporated  
P.O. Box 07130  
Detroit, MI 48207  
1-800-551-4123  
helminc.com

## Index

To quickly locate information about the vehicle use the Index in the back of the manual. It is an alphabetical list of what is in the manual and the page number where it can be found.

©2008 General Motors Corporation. All Rights Reserved.

## Safety Warnings and Symbols

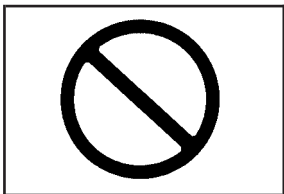

A circle with a slash through it is a safety symbol which means “Do Not,” “Do not do this” or “Do not let this happen.”

A box with the word CAUTION is used to tell about things that could hurt you or others if you were to ignore the warning.

### CAUTION:

These mean there is something that could hurt you or other people.

Cautions tell what the hazard is and what to do to avoid or reduce the hazard. Read these cautions.

A notice tells about something that can damage the vehicle.

**Notice:** These mean there is something that could damage your vehicle.

Many times, this damage would not be covered by the vehicle’s warranty, and it could be costly. The notice tells what to do to help avoid the damage.

There are also warning labels on the vehicle which use the same words, CAUTION or Notice.

# Section 1 Seats and Restraint System

---

<b>Front Seats</b> .....	1-2	Lower Anchors and Tethers for Children (LATCH) .....	1-33
Power Seats .....	1-2	Securing a Child Restraint in the Right Front Seat Position .....	1-34
Power Lumbar .....	1-2	<b>Airbag System</b> .....	1-38
Heated and Cooled Seats .....	1-3	Where Are the Airbags? .....	1-40
Memory Seat, Mirrors and Steering Wheel .....	1-3	When Should an Airbag Inflate? .....	1-42
Power Reclining Seatbacks .....	1-4	What Makes an Airbag Inflate? .....	1-43
<b>Safety Belts</b> .....	1-6	How Does an Airbag Restrain? .....	1-43
Safety Belts: They Are for Everyone .....	1-6	What Will You See After an Airbag Inflates? .....	1-44
How to Wear Safety Belts Properly .....	1-11	Passenger Sensing System .....	1-45
Lap-Shoulder Belt .....	1-20	Servicing Your Airbag-Equipped Vehicle .....	1-50
Safety Belt Use During Pregnancy .....	1-22	Adding Equipment to Your Airbag-Equipped Vehicle .....	1-50
Safety Belt Extender .....	1-23	<b>Restraint System Check</b> .....	1-52
<b>Child Restraints</b> .....	1-23	Checking the Restraint Systems .....	1-52
Older Children .....	1-23	Replacing Restraint System Parts After a Crash .....	1-53
Infants and Young Children .....	1-27		
Child Restraint Systems .....	1-31		

## Front Seats

### Power Seats

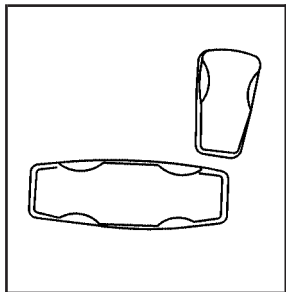

The power seat controls are located on the outboard side of the seat cushions.

- Move the seat forward or rearward by sliding the horizontal control forward or rearward.
- Raise or lower the front part of the seat cushion by moving the front of the horizontal control up or down.
- Raise or lower the rear part of the seat cushion by moving the rear of the horizontal control up or down.
- Raise or lower the entire seat by moving the entire horizontal control up or down.
- Use the vertical control to recline the seatback. See *Power Reclining Seatbacks* on page 1-4.

### Power Lumbar

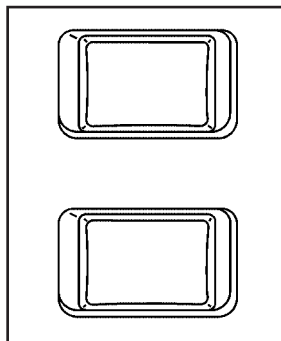

The driver and passenger seatback lumbar support switches are located on the outboard sides of the seats.

- Use the power seat controls first to get the proper position, then continue with the lumbar adjustment.
- The top lumbar switch adjusts support to the middle seatback and the bottom lumbar switch adjusts support to the lower seatback.
- Press the front of the switch to increase support and the rear of the switch to decrease support.

Remember to readjust lumbar support as your seating position changes.

## Heated and Cooled Seats

The buttons for the heated and cooled seats are located on the climate control system.

 **(Heated/Cooled Seat):** Press to turn the feature on. The button on the left controls the driver seat and the button on the right controls the passenger seat. Each press of the button will take you to a different setting. The settings available in order are HI HEAT, LO HEAT, OFF, HI COOL, LO COOL and OFF. You will be able to feel the temperature change in a few minutes.

The feature will automatically turn off when the vehicle is turned off. See *Dual Climate Control System* on page 3-36 for more information.

## Memory Seat, Mirrors and Steering Wheel

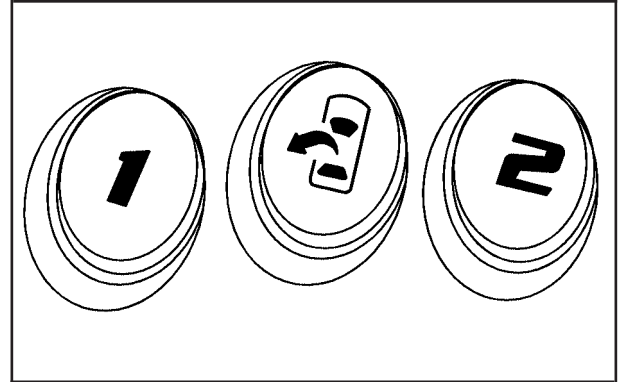

The vehicle is equipped with a memory package. The controls are located on the driver seat, and are used to program and recall memory settings for the driver seating positions.

Use the following steps to program each button:

1. Adjust the driver seat including the seatback recliner, lumbar, both outside mirrors and the steering wheel to a comfortable position.
2. Press and hold button 1 until two beeps are heard, then release the button.

A second mirror, seating and steering wheel position can be programmed by repeating the above steps and pressing button 2 (for driver 2). Each time a memory button is pressed and released, a single beep will sound. Each time button 1 or 2 is pressed and released while the vehicle is in P (Park), the memory positions will be recalled after a brief delay. If the vehicle is not in P (Park), three beeps will be heard and the memory position will not be recalled.

When the engine is started, the seat, mirrors, and steering wheel may automatically adjust to their programmed positions.

To stop recall movement of the memory feature at any time, press one of the power seat controls, power mirror control buttons, memory buttons, or power steering column control.

Two personalized exit positions can be set by first recalling the driving position (by pressing 1 or 2), then positioning the steering wheel and seat in the desired exit positions and then pressing and holding the exit button until two beeps are heard. The exit button is located

between buttons 1 and 2. With the vehicle in Park (P), the exit position for the previously set driver can be recalled by pressing the exit button.

When you use the keyless access transmitter to unlock your vehicle, automatic seat and steering wheel movement to the exit position may occur. The numbers on the back of the transmitter, 1 and 2, corresponds to the numbers on the memory buttons.

Further programming for automatic seat and mirror movement can be done using the Driver Information Center (DIC).

For programming information, see *DIC Vehicle Personalization* on page 3-72.

## Power Reclining Seatbacks

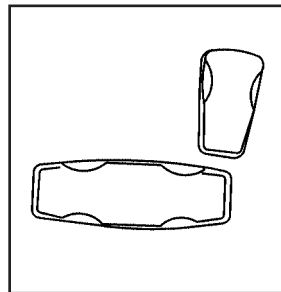

Your seats have power reclining seatbacks.



Use the vertical power seat control located on the outboard side of the seat to operate them.

- To recline the seatback, press the control toward the rear of the vehicle.
- To raise the seatback, press the control toward the front of the vehicle.

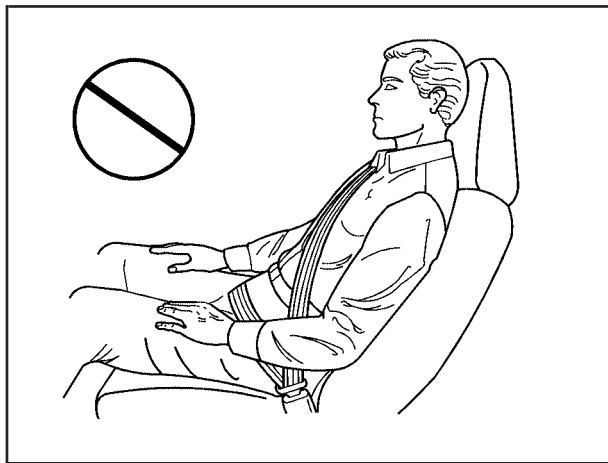

## CAUTION:

Sitting in a reclined position when your vehicle is in motion can be dangerous. Even if you buckle up, your safety belts cannot do their job when you are reclined like this.

The shoulder belt cannot do its job. In a crash, you could go into it, receiving neck or other injuries.

The lap belt cannot do its job either. In a crash the belt could go up over your abdomen. The belt forces would be there, not at your pelvic bones. This could cause serious internal injuries.

For proper protection when the vehicle is in motion, have the seatback upright. Then sit well back in the seat and wear your safety belt properly.

Do not have a seatback reclined if your vehicle is moving.

# Safety Belts

## Safety Belts: They Are for Everyone

This section of the manual describes how to use safety belts properly. It also describes some things not to do with safety belts.

### CAUTION:

Do not let anyone ride where a safety belt cannot be worn properly. In a crash, if you or your passenger(s) are not wearing safety belts, the injuries can be much worse. You can hit things inside the vehicle harder or be ejected from the vehicle. You and your passenger(s) can be seriously injured or killed. In the same crash, you might not be, if you are buckled up. Always fasten your safety belt, and check that your passenger(s) are restrained properly too.

### CAUTION:

It is extremely dangerous to ride in a cargo area, inside or outside of a vehicle. In a collision, people riding in these areas are more likely to be seriously injured or killed. Do not allow people to ride in any area of your vehicle that is not equipped with seats and safety belts. Be sure everyone in your vehicle is in a seat and using a safety belt properly.

This vehicle has indicators as a reminder to buckle the safety belts. See *Safety Belt Reminders on page 3-44* for additional information.

In most states and in all Canadian provinces, the law requires wearing safety belts. Here is why:

You never know if you will be in a crash. If you do have a crash, you do not know if it will be a serious one.

A few crashes are mild, and some crashes can be so serious that even buckled up, a person would not survive. But most crashes are in between. In many of them, people who buckle up can survive and sometimes walk away. Without safety belts, they could have been badly hurt or killed.

After more than 40 years of safety belts in vehicles, the facts are clear. In most crashes buckling up does matter... a lot!

## Why Safety Belts Work

When you ride in or on anything, you go as fast as it goes.

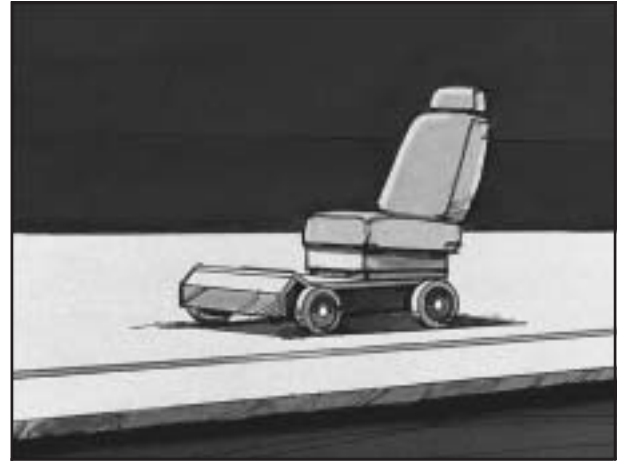

Take the simplest vehicle. Suppose it is just a seat on wheels.



Put someone on it.

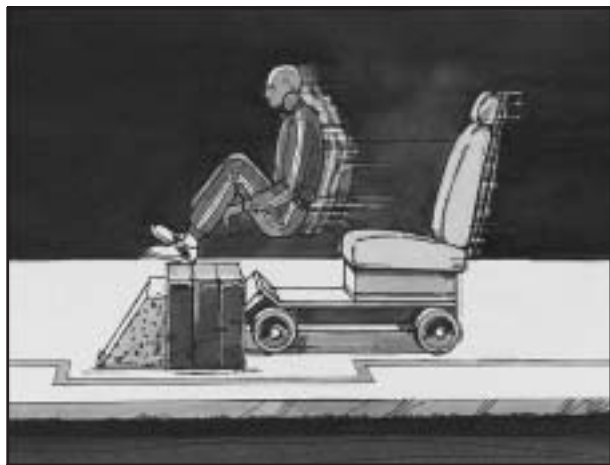

Get it up to speed. Then stop the vehicle.  
The rider does not stop.



The person keeps going until stopped by something.  
In a real vehicle, it could be the windshield...



or the instrument panel...



or the safety belts!

With safety belts, you slow down as the vehicle does. You get more time to stop. You stop over more distance, and your strongest bones take the forces. That is why safety belts make such good sense.

## Questions and Answers About Safety Belts

**Q:** Will I be trapped in the vehicle after a crash if I am wearing a safety belt?

**A:** You *could* be — whether you are wearing a safety belt or not. But your chance of being conscious during and after an accident, so you *can* unbuckle and get out, is *much* greater if you are belted. And you can unbuckle a safety belt, even if you are upside down.

**Q:** If my vehicle has airbags, why should I have to wear safety belts?

**A:** Airbags are supplemental systems only; so they work *with* safety belts — not instead of them. Whether or not an airbag is provided, all occupants still have to buckle up to get the most protection. That is true not only in frontal collisions, but especially in side and other collisions.

**Q:** If I am a good driver, and I never drive far from home, why should I wear safety belts?

**A:** You may be an excellent driver, but if you are in a crash — even one that is not your fault — you and your passenger(s) can be hurt. Being a good driver does not protect you from things beyond your control, such as bad drivers.

Most accidents occur within 25 miles (40 km) of home. And the greatest number of serious injuries and deaths occur at speeds of less than 40 mph (65 km/h).

Safety belts are for everyone.

## How to Wear Safety Belts Properly

This section is only for people of adult size.

Be aware that there are special things to know about safety belts and children. And there are different rules for smaller children and infants. If a child will be riding in the vehicle, see *Older Children on page 1-23* or *Infants and Young Children on page 1-27*. Follow those rules for everyone's protection.

It is very important for all occupants to buckle up. Statistics show that unbelted people are hurt more often in crashes than those who are wearing safety belts.

Occupants who are not buckled up can be thrown out of the vehicle in a crash. And they can strike others in the vehicle who are wearing safety belts.

First, before you or your passenger(s) wear a safety belt, there is important information you should know.

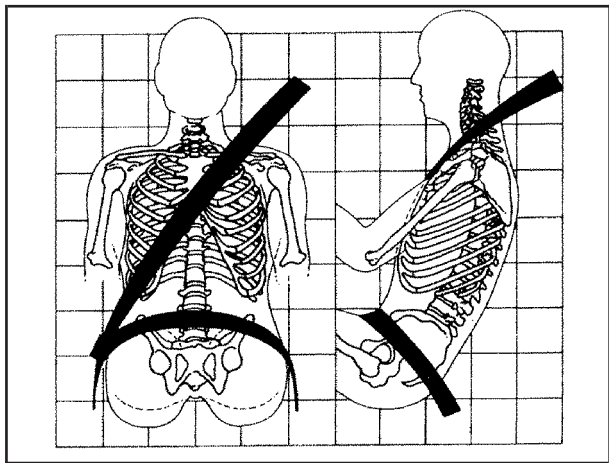

In a crash, this applies force to the strong pelvic bones and you would be less likely to slide under the lap belt. If you slid under it, the belt would apply force on your abdomen. This could cause serious or even fatal injuries. The shoulder belt should go over the shoulder and across the chest. These parts of the body are best able to take belt restraining forces.

The shoulder belt locks if there is a sudden stop or crash.

Sit up straight and always keep your feet on the floor in front of you. The lap part of the belt should be worn low and snug on the hips, just touching the thighs.



**Q:** What is wrong with this?

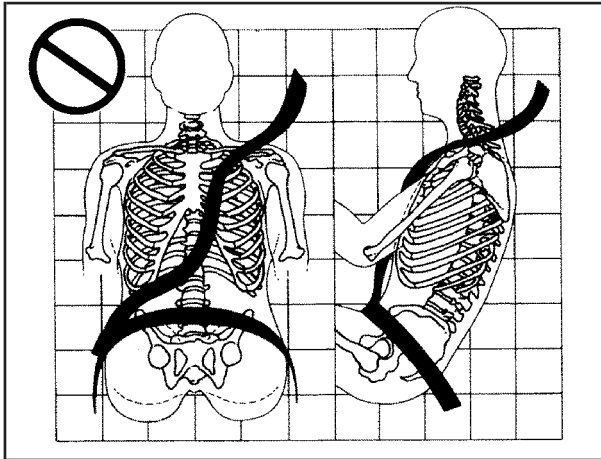

**A:** The shoulder belt is too loose. It will not give as much protection this way.

**⚠ CAUTION:**

You can be seriously hurt if your shoulder belt is too loose. In a crash, you would move forward too much, which could increase injury. The shoulder belt should fit snugly against your body.

**Q:** What is wrong with this?

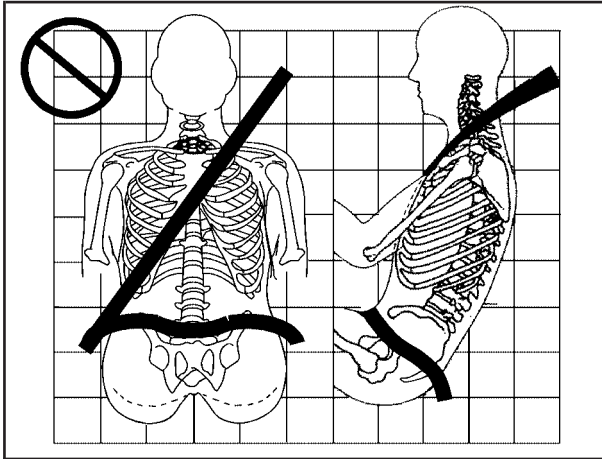

**A:** The lap belt is too loose. It will not give nearly as much protection this way.

**⚠ CAUTION:**

You can be seriously hurt if your lap belt is too loose. In a crash, you could slide under the lap belt and apply force on your abdomen. This could cause serious or even fatal injuries. The lap belt should be worn low and snug on the hips, just touching the thighs.

**Q:** What is wrong with this?

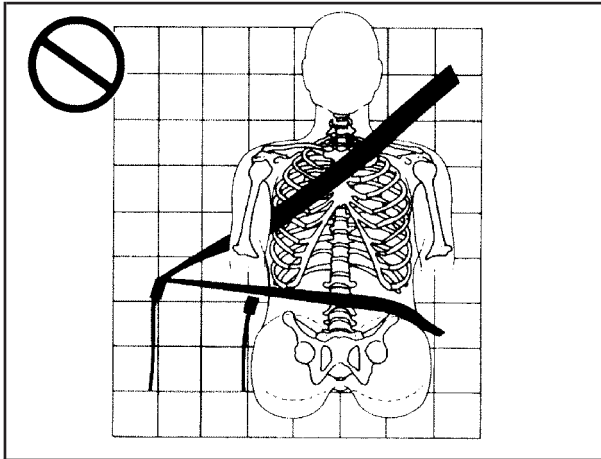

**A:** The belt is buckled in the wrong buckle.

**⚠ CAUTION:**

You can be seriously injured if your belt is buckled in the wrong place like this. In a crash, the belt would go up over your abdomen. The belt forces would be there, not on the pelvic bones. This could cause serious internal injuries. Always buckle your belt into the buckle nearest you.

**Q:** What is wrong with this?

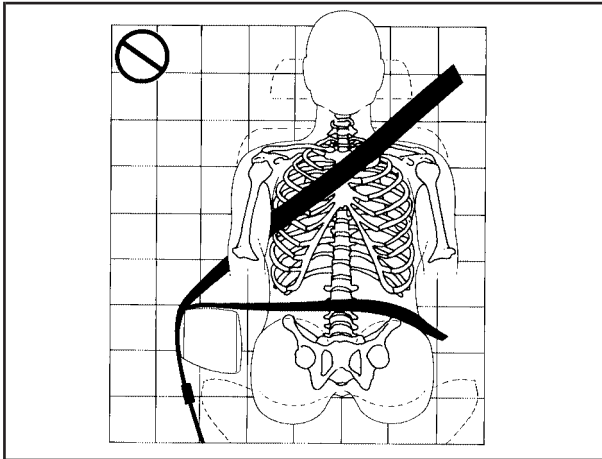

**A:** The belt is over an armrest.

**⚠ CAUTION:**

You can be seriously injured if your belt goes over an armrest like this. The belt would be much too high. In a crash, you can slide under the belt. The belt force would then be applied on the abdomen, not on the pelvic bones, and that could cause serious or fatal injuries. Be sure the belt goes under the armrests.

**Q:** What is wrong with this?

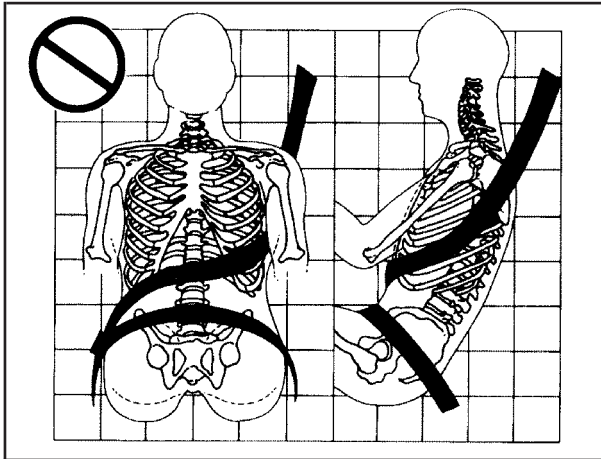

**A:** The shoulder belt is worn under the arm. It should be worn over the shoulder at all times.

**⚠ CAUTION:**

You can be seriously injured if you wear the shoulder belt under your arm. In a crash, your body would move too far forward, which would increase the chance of head and neck injury. Also, the belt would apply too much force to the ribs, which are not as strong as shoulder bones. You could also severely injure internal organs like your liver or spleen. The shoulder belt should go over the shoulder and across the chest.

**Q:** What is wrong with this?

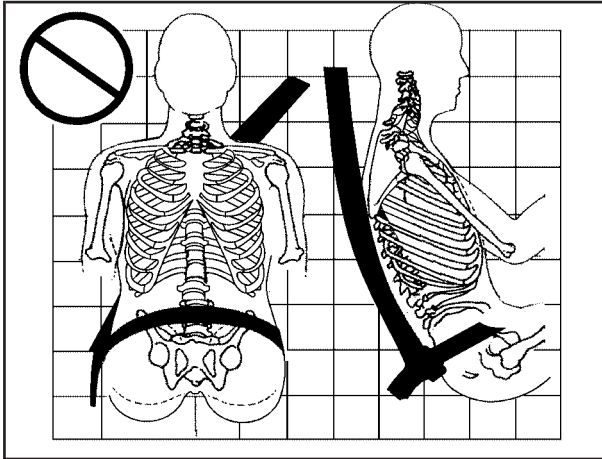

**A:** The belt is behind the body.

**⚠ CAUTION:**

You can be seriously injured by not wearing the lap-shoulder belt properly. In a crash, you would not be restrained by the shoulder belt. Your body could move too far forward increasing the chance of head and neck injury. You might also slide under the lap belt. The belt force would then be applied right on the abdomen. That could cause serious or fatal injuries. The shoulder belt should go over the shoulder and across the chest.

**Q:** What is wrong with this?

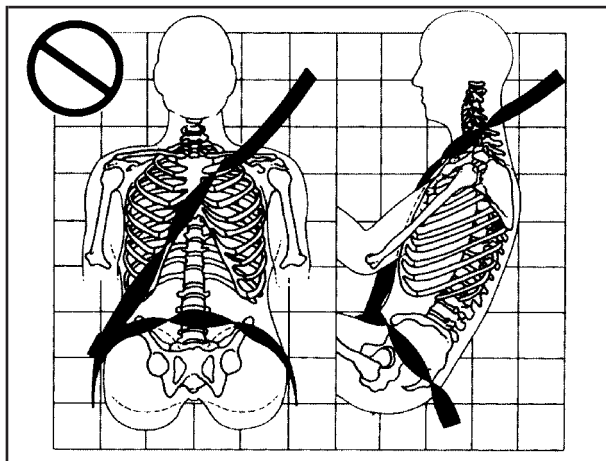

**A:** The belt is twisted across the body.

**⚠ CAUTION:**

You can be seriously injured by a twisted belt. In a crash, you would not have the full width of the belt to spread impact forces. If a belt is twisted, make it straight so it can work properly, or ask your dealer/retailer to fix it.

## Lap-Shoulder Belt

All seating positions in the vehicle have a lap-shoulder belt.

The following instructions explain how to wear a lap-shoulder belt properly.

1. Adjust the seat, if the seat is adjustable, so you can sit up straight. To see how, see “Seats” in the Index.
2. Pick up the latch plate and pull the belt across you. Do not let it get twisted.

The lap-shoulder belt may lock if you pull the belt across you very quickly. If this happens, let the belt go back slightly to unlock it. Then pull the belt across you more slowly.

If the shoulder portion of a passenger belt is pulled out all the way, the child restraint locking feature may be engaged. If this happens, let the belt go back all the way and start again.

Engaging the child restraint locking feature in the right front seating position may affect the passenger sensing system. See *Passenger Sensing System* on page 1-45 for more information.

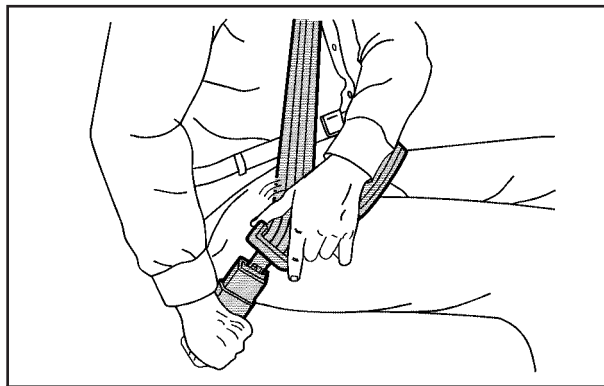

3. Push the latch plate into the buckle until it clicks. Pull up on the latch plate to make sure it is secure. If the belt is not long enough, see *Safety Belt Extender* on page 1-23.  
Position the release button on the buckle so that the safety belt could be quickly unbuckled if necessary.



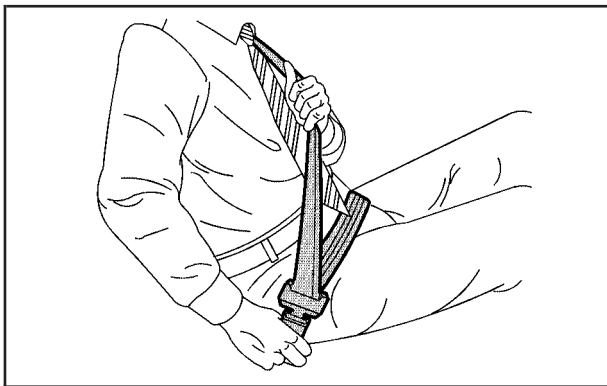

4. To make the lap part tight, pull up on the shoulder belt.

It may be necessary to pull stitching on the safety belt through the latch plate to fully tighten the lap belt on smaller occupants.

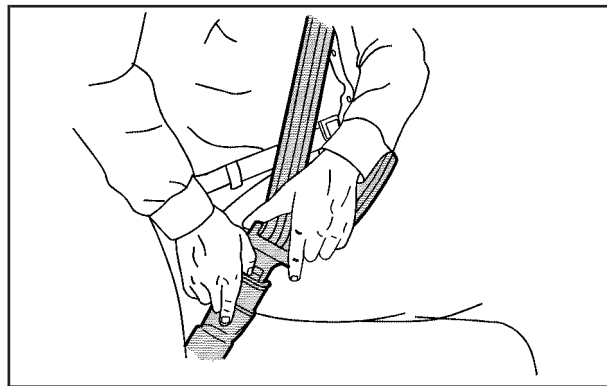

To unlatch the belt, push the button on the buckle. The belt should return to its stowed position.

Before a door is closed, be sure the safety belt is out of the way. If a door is slammed against a safety belt, damage can occur to both the safety belt and the vehicle.

## Safety Belt Pretensioners

This vehicle has safety belt pretensioners for the front outboard occupants. Although the safety belt pretensioners cannot be seen, they are part of the safety belt assembly. They can help tighten the safety belts during the early stages of a moderate to severe frontal and near frontal crash if the threshold conditions for pretensioner activation are met. And, for vehicles with side impact airbags, safety belt pretensioners can help tighten the safety belts in a side crash.

Pretensioners work only once. If the pretensioners activate in a crash, they will need to be replaced, and probably other new parts for the vehicle's safety belt system. See *Replacing Restraint System Parts After a Crash* on page 1-53.

## Safety Belt Use During Pregnancy

Safety belts work for everyone, including pregnant women. Like all occupants, they are more likely to be seriously injured if they do not wear safety belts.

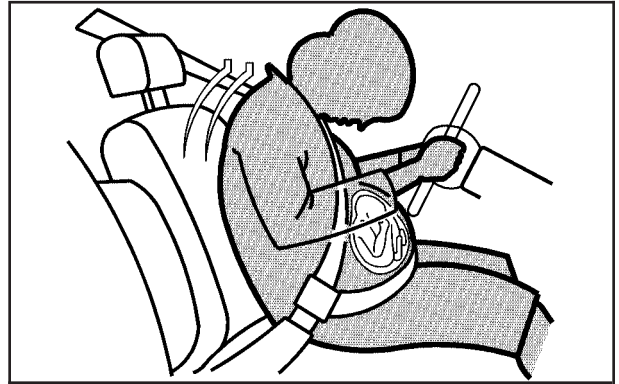

A pregnant woman should wear a lap-shoulder belt, and the lap portion should be worn as low as possible, below the rounding, throughout the pregnancy.

The best way to protect the fetus is to protect the mother. When a safety belt is worn properly, it is more likely that the fetus will not be hurt in a crash. For pregnant women, as for anyone, the key to making safety belts effective is wearing them properly.

## Safety Belt Extender

If the safety belt will fasten around you, you should use it.

But if a safety belt is not long enough, your dealer/retailer will order you an extender. When you go in to order it, take the heaviest coat you will wear, so the extender will be long enough for you. To help avoid personal injury, do not let someone else use it, and use it only for the seat it is made to fit. The extender has been designed for adults. Never use it for securing child seats. To wear it, attach it to the regular safety belt. For more information, see the instruction sheet that comes with the extender.

## Child Restraints

### Older Children

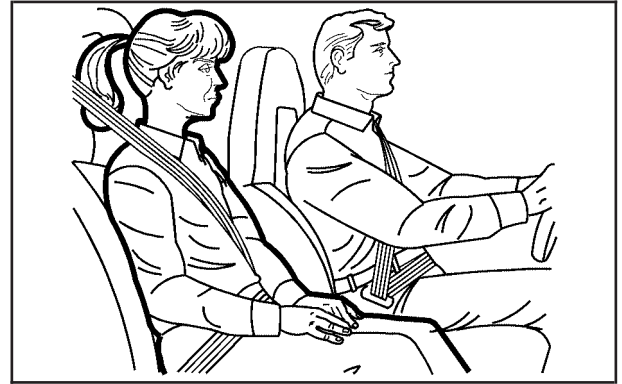

Older children who have outgrown booster seats should wear the vehicle's safety belts.

The manufacturer's instructions that come with the booster seat, state the weight and height limitations for that booster. Use a booster seat with a lap-shoulder belt until the child passes the below fit test:

- Sit all the way back on the seat. Do the knees bend at the seat edge? If yes, continue. If no, return to the booster seat.
- Buckle the lap-shoulder belt. Does the shoulder belt rest on the shoulder? If yes, continue. If no, then return to the booster seat.
- Does the lap belt fit low and snug on the hips, touching the thighs? If yes, continue. If no, return to the booster seat.
- Can proper safety belt fit be maintained for the length of the trip? If yes, continue. If no, return to the booster seat.

**Q: What is the proper way to wear safety belts?**

**A:** An older child should wear a lap-shoulder belt and get the additional restraint a shoulder belt can provide. The shoulder belt should not cross the face or neck. The lap belt should fit snugly below the hips, just touching the top of the thighs. This applies belt force to the child's pelvic bones in a crash. It should never be worn over the abdomen, which could cause severe or even fatal internal injuries in a crash.

According to accident statistics, children and infants are safer when properly restrained in rear seating positions than in the front seating positions.

In a crash, children who are not buckled up can strike other people who are buckled up, or can be thrown out of the vehicle. Older children need to use safety belts properly.

**⚠ CAUTION:**

Never do this.

Never allow two children to wear the same safety belt. The safety belt can not properly spread the impact forces. In a crash, the two children can be crushed together and seriously injured. A safety belt must be used by only one person at a time.



**⚠ CAUTION:**

Never do this.

Never allow a child to wear the safety belt with the shoulder belt behind their back. A child can be seriously injured by not wearing the lap-shoulder belt properly. In a crash, the child would not be restrained by the shoulder belt. The child could move too far forward increasing the chance of head and neck injury. The child might also slide under the lap belt. The belt force would then be applied right on the abdomen. That could cause serious or fatal injuries. The shoulder belt should go over the shoulder and across the chest.



## Infants and Young Children

Everyone in a vehicle needs protection! This includes infants and all other children. Neither the distance traveled nor the age and size of the traveler changes the need, for everyone, to use safety restraints. In fact, the law in every state in the United States and in every Canadian province says children up to some age must be restrained while in a vehicle.

### CAUTION:

Children can be seriously injured or strangled if a shoulder belt is wrapped around their neck and the safety belt continues to tighten. Never leave children unattended in a vehicle and never allow children to play with the safety belts.

Airbags plus lap-shoulder belts offer protection for adults and older children, but not for young children and infants. Neither the vehicle's safety belt system nor its airbag system is designed for them. Every time infants and young children ride in vehicles, they should have the protection provided by appropriate child restraints.

Children who are not restrained properly can strike other people, or can be thrown out of the vehicle.

**⚠ CAUTION:**

Never do this.

Never hold an infant or a child while riding in a vehicle. Due to crash forces, an infant or a child will become so heavy it is not possible to hold it during a crash. For example, in a crash at only 25 mph (40 km/h), a 12 lb (5.5 kg) infant will suddenly become a 240 lb (110 kg) force on a person's arms. An infant should be secured in an appropriate restraint.

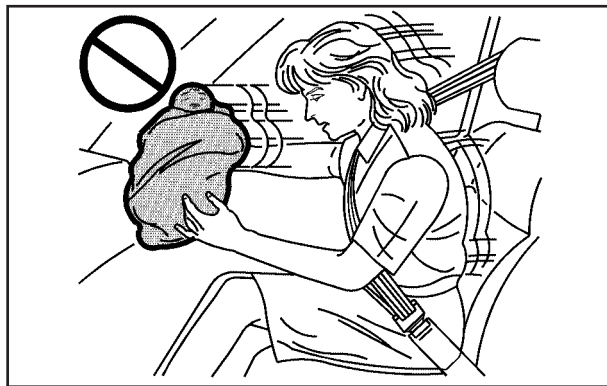



**⚠ CAUTION:**

Never do this.

Children who are up against, or very close to, any airbag when it inflates can be seriously injured or killed. Never put a rear-facing child restraint in the right front seat. Secure a rear-facing child restraint in a rear seat. It is also better to secure a forward-facing child restraint in a rear seat. If you must secure a forward-facing child restraint in the right front seat, always move the front passenger seat as far back as it will go.



**Q:** What are the different types of add-on child restraints?

**A:** Add-on child restraints, which are purchased by the vehicle's owner, are available in four basic types. Selection of a particular restraint should take into consideration not only the child's weight, height, and age but also whether or not the restraint will be compatible with the motor vehicle in which it will be used.

For most basic types of child restraints, there are many different models available. When purchasing a child restraint, be sure it is designed to be used in a motor vehicle. If it is, the restraint will have a label saying that it meets federal motor vehicle safety standards.

The restraint manufacturer's instructions that come with the restraint state the weight and height limitations for a particular child restraint. In addition, there are many kinds of restraints available for children with special needs.

 **CAUTION:**

To reduce the risk of neck and head injury during a crash, infants need complete support. This is because an infant's neck is not fully developed and its head weighs so much compared with the rest of its body. In a crash, an infant in a rear-facing child restraint settles into the restraint, so the crash forces can be distributed across the strongest part of an infant's body, the back and shoulders. Infants should always be secured in rear-facing child restraints.

**⚠ CAUTION:**

A young child's hip bones are still so small that the vehicle's regular safety belt may not remain low on the hip bones, as it should. Instead, it may settle up around the child's abdomen. In a crash, the belt would apply force on a body area that is unprotected by any bony structure. This alone could cause serious or fatal injuries. To reduce the risk of serious or fatal injuries during a crash, young children should always be secured in appropriate child restraints.

## Child Restraint Systems

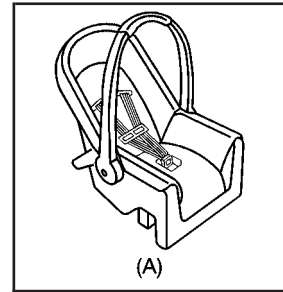

A rear-facing infant seat (A) provides restraint with the seating surface against the back of the infant.

The harness system holds the infant in place and, in a crash, acts to keep the infant positioned in the restraint.

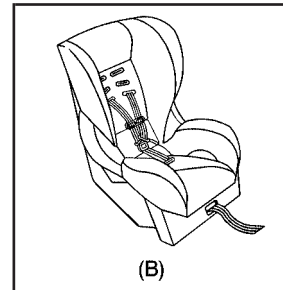

A forward-facing child seat (B) provides restraint for the child's body with the harness.

## Securing an Add-on Child Restraint in the Vehicle

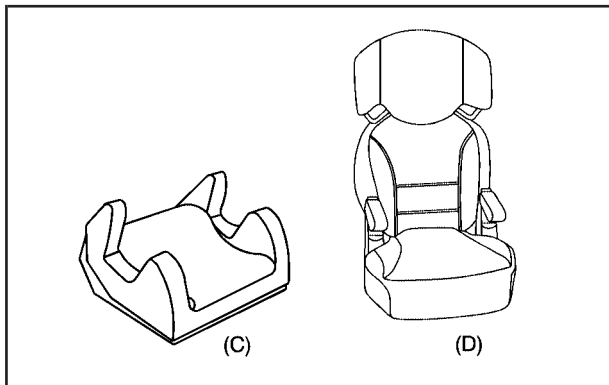

A booster seat (C-D) is a child restraint designed to improve the fit of the vehicle's safety belt system. A booster seat can also help a child to see out the window.

### **CAUTION:**

A child can be seriously injured or killed in a crash if the child restraint is not properly secured in the vehicle. Secure the child restraint properly in the vehicle using the vehicle's safety belt, following the instructions that came with that child restraint and the instructions in this manual.

To help reduce the chance of injury, the child restraint must be secured in the vehicle. Child restraint systems must be secured in vehicle seats by lap belts or the lap belt portion of a lap-shoulder belt. A child can be endangered in a crash if the child restraint is not properly secured in the vehicle.

When securing an add-on child restraint, refer to the instructions that come with the restraint which may be on the restraint itself or in a booklet, or both, and to this manual. The child restraint instructions are important, so if they are not available, obtain a replacement copy from the manufacturer.

Keep in mind that an unsecured child restraint can move around in a collision or sudden stop and injure people in the vehicle. Be sure to properly secure any child restraint in your vehicle — even when no child is in it.

## Securing the Child Within the Child Restraint

### **CAUTION:**

A child can be seriously injured or killed in a crash if the child is not properly secured in the child restraint. Secure the child properly following the instructions that came with that child restraint.

## Lower Anchors and Tethers for Children (LATCH)

Some child restraints have a LATCH system. As part of the LATCH system, your child restraint may have lower attachments and/or a top tether. The LATCH system can help hold the child restraint in place during driving or in a crash. Some vehicles have lower and/or top tether anchors designed to secure a child restraint with lower attachments and/or a top tether.

Some child restraints with a top tether are designed to be used whether the top tether is anchored or not. Other child restraints require that the top tether be anchored. A national or local law may require that the top tether be anchored.

In Canada, the law requires that forward-facing child restraints have a top tether, and that the tether be attached.

Your vehicle does not have lower anchors or top tether anchors to secure a child restraint with the LATCH system. If a national or local law requires that your top tether be anchored, do not use a child restraint in this vehicle because a top tether cannot be properly anchored. You must use the safety belts to secure your child restraint in this vehicle, unless a national or local law requires that the top tether be anchored. Refer to your child restraint instructions and instructions in this manual for securing a child restraint using the vehicle's safety belts.

## Securing a Child Restraint in the Right Front Seat Position

This vehicle has airbags. In addition, the vehicle has a passenger sensing system which is designed to turn off the right front passenger frontal airbag and seat-mounted side impact airbag under certain conditions. See *Passenger Sensing System on page 1-45* and *Passenger Airbag Status Indicator on page 3-45* for more information, including important safety information.

A label on the sun visor says, “Never put a rear-facing child seat in the front.” This is because the risk to the rear-facing child is so great, if the airbag deploys.

### CAUTION:

A child in a rear-facing child restraint can be seriously injured or killed if the right front passenger airbag inflates. This is because the back of the rear-facing child restraint would be very close to the

CAUTION: (Continued)

### CAUTION: (Continued)

inflating airbag. A child in a forward-facing child restraint can be seriously injured or killed if the right front passenger airbag inflates and the passenger seat is in a forward position.

Even if the passenger sensing system has turned off the right front passenger frontal airbag, no system is fail-safe. No one can guarantee that an airbag will not deploy under some unusual circumstance, even though it is turned off.

Secure rear-facing child restraints in a rear seat, even if the airbag is off. If you secure a forward-facing child restraint in the right front seat, always move the front passenger seat as far back as it will go. It is better to secure the child restraint in a rear seat.

See *Passenger Sensing System on page 1-45* for additional information.

Rear-facing child restraints should not be installed in the vehicle, even if the airbags are off.

If your child restraint has the LATCH system, see *Lower Anchors and Tethers for Children (LATCH)* on page 1-33 for how and where to install the child restraint using LATCH. If a child restraint is secured using a safety belt and it uses a top tether, see *Lower Anchors and Tethers for Children (LATCH)* on page 1-33 for top tether anchor locations.

Do not secure a child seat in a position without a top tether anchor if a national or local law requires that the top tether be anchored, or if the instructions that come with the child restraint say that the top strap must be anchored.

In Canada, the law requires that forward-facing child restraints have a top tether, and that the tether be attached.

You will be using the lap-shoulder belt to secure the child restraint in this position. Follow the instructions that came with the child restraint.

1. Move the seat as far back as it will go before securing the forward-facing child restraint.  
When the passenger sensing system has turned off the right front passenger frontal airbag and seat-mounted side impact airbag, the off indicator on the passenger airbag status indicator should light and stay lit when you start the vehicle. See *Passenger Airbag Status Indicator* on page 3-45.
2. Put the child restraint on the seat.
3. Pick up the latch plate, and run the lap and shoulder portions of the vehicle's safety belt through or around the restraint. The child restraint instructions will show you how.

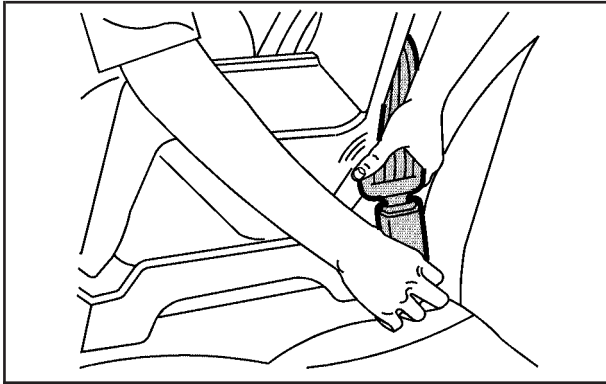

4. Push the latch plate into the buckle until it clicks. Position the release button on the buckle so that the safety belt could be quickly unbuckled if necessary.

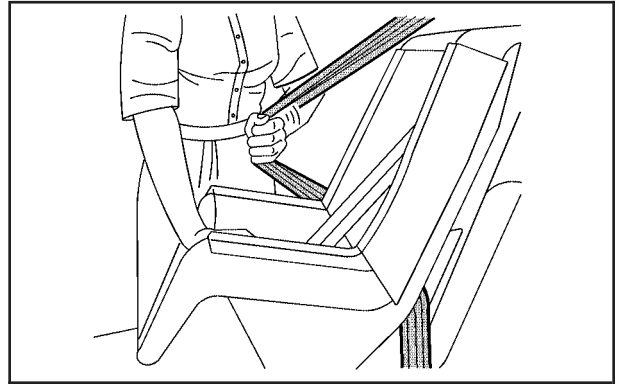

5. Pull the rest of the shoulder belt all the way out of the retractor to set the lock.



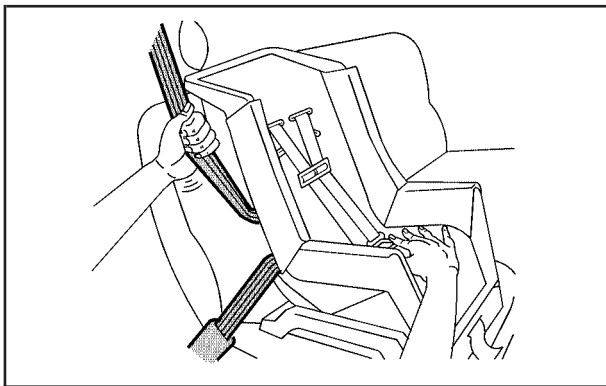

6. To tighten the belt, push down on the child restraint, pull the shoulder portion of the belt to tighten the lap portion of the belt and feed the shoulder belt back into the retractor. When installing a forward-facing child restraint, it may be helpful to use your knee to push down on the child restraint as you tighten the belt.
7. Push and pull the child restraint in different directions to be sure it is secure.

If the airbags are off, the off indicator in the passenger airbag status indicator will come on and stay on when the vehicle is started.

If a child restraint has been installed and the on indicator is lit, see “If the On Indicator is Lit for a Child Restraint” under *Passenger Sensing System on page 1-45* for more information.

To remove the child restraint, unbuckle the vehicle safety belt and let it return to the stowed position.

# Airbag System

The vehicle has the following airbags:

- A frontal airbag for the driver.
- A frontal airbag for the right front passenger.
- A seat-mounted side impact airbag for the driver.
- A seat-mounted side impact airbag for the right front passenger.

All of the airbags in your vehicle will have the word AIRBAG embossed in the trim or on an attached label near the deployment opening.

For frontal airbags, the word AIRBAG will appear on the middle part of the steering wheel for the driver and on the instrument panel for the right front passenger.

With seat-mounted side impact airbags, the word AIRBAG will appear on the side of the seatback closest to the door.

Airbags are designed to supplement the protection provided by safety belts. Even though today's airbags are also designed to help reduce the risk of injury from the force of an inflating bag, all airbags must inflate very quickly to do their job.

Here are the most important things to know about the airbag system:

## CAUTION:

You can be severely injured or killed in a crash if you are not wearing your safety belt — even if you have airbags. Airbags are designed to work with safety belts, but do not replace them. Also, airbags are not designed to deploy in every crash. In some crashes safety belts are your only restraint. See *When Should an Airbag Inflate?* on page 1-42.

Wearing your safety belt during a crash helps reduce your chance of hitting things inside the vehicle or being ejected from it. Airbags are “supplemental restraints” to the safety belts. Everyone in your vehicle should wear a safety belt properly — whether or not there is an airbag for that person.

**⚠ CAUTION:**

Airbags inflate with great force, faster than the blink of an eye. Anyone who is up against, or very close to, any airbag when it inflates can be seriously injured or killed. Do not sit unnecessarily close to the airbag, as you would be if you were sitting on the edge of your seat or leaning forward. Safety belts help keep you in position before and during a crash. Always wear your safety belt, even with airbags. The driver should sit as far back as possible while still maintaining control of the vehicle.

Occupants should not lean on or sleep against the door or side windows in seating positions with seat-mounted airbags.

**⚠ CAUTION:**

Children who are up against, or very close to, any airbag when it inflates can be seriously injured or killed. Airbags plus lap-shoulder belts offer protection for adults and older children, but not for young children and infants. Neither the vehicle's safety belt system nor its airbag system is designed for them. Young children and infants need the protection that a child restraint system can provide. Always secure children properly in your vehicle. To read how, see *Older Children on page 1-23* or *Infants and Young Children on page 1-27*.



There is an airbag readiness light on the instrument panel cluster, which shows the airbag symbol.

The system checks the airbag electrical system for malfunctions. The light tells you if there is an electrical problem. See *Airbag Readiness Light on page 3-44* for more information.

## Where Are the Airbags?



The driver frontal airbag is in the middle of the steering wheel.



The passenger frontal airbag is in the instrument panel on the passenger side.



**Driver Side shown, Passenger Side similar**

The seat-mounted side impact airbags for the driver and right front passenger are in the side of the seatbacks closest to the door.

**⚠ CAUTION:**

If something is between an occupant and an airbag, the airbag might not inflate properly or it might force the object into that person causing severe injury or even death. The path of an inflating airbag must be kept clear. Do not put anything between an occupant and an airbag, and do not attach or put anything on the steering wheel hub or on or near any other airbag covering.

Do not use seat accessories that block the inflation path of a seat-mounted side impact airbag.

## When Should an Airbag Inflate?

Frontal airbags are designed to inflate in moderate to severe frontal or near-frontal crashes to help reduce the potential for severe injuries mainly to the driver's or right front passenger's head and chest. However, they are only designed to inflate if the impact exceeds a predetermined deployment threshold. Deployment thresholds are used to predict how severe a crash is likely to be in time for the airbags to inflate and help restrain the occupants.

Whether your frontal airbags will or should deploy is not based on how fast your vehicle is traveling. It depends largely on what you hit, the direction of the impact, and how quickly your vehicle slows down.

Frontal airbags may inflate at different crash speeds. For example:

- If the vehicle hits a stationary object, the airbags could inflate at a different crash speed than if the vehicle hits a moving object.
- If the vehicle hits an object that deforms, the airbags could inflate at a different crash speed than if the vehicle hits an object that does not deform.
- If the vehicle hits a narrow object (like a pole), the airbags could inflate at a different crash speed than if the vehicle hits a wide object (like a wall).
- If the vehicle goes into an object at an angle, the airbags could inflate at a different crash speed than if the vehicle goes straight into the object.

Thresholds can also vary with specific vehicle design. In addition, your vehicle has dual-stage frontal airbags. Dual-stage airbags adjust the restraint according to crash severity. Your vehicle has electronic frontal sensors, which help the sensing system distinguish between a moderate frontal impact and a more severe frontal impact. For moderate frontal impacts, dual-stage airbags inflate at a level less than full deployment. For more severe frontal impacts, full deployment occurs.

Frontal airbags are not intended to inflate during vehicle rollovers, rear impacts, or in many side impacts.

The vehicle has seat-mounted side impact airbags. See *Airbag System on page 1-38*. Seat-mounted side impact airbags are intended to inflate in moderate to severe side crashes. Seat-mounted side impact airbags will inflate if the crash severity is above the system's designed threshold level. The threshold level can vary with specific vehicle design.

Seat-mounted side impact airbags are not intended to inflate in frontal impacts, near-frontal impacts, rollovers, or rear impacts. A seat-mounted side impact airbag is intended to deploy on the side of the vehicle that is struck.

The vehicle has seat position sensors which enables the sensing system to monitor the position of the driver seat and the right front passenger seat. Seat position sensors provide information that is used to determine if the airbags should deploy at a reduced level or at full deployment.

In any particular crash, no one can say whether an airbag should have inflated simply because of the damage to a vehicle or because of what the repair costs were. For seat-mounted side impact airbags, deployment is determined by the location and severity of the side impact.

## What Makes an Airbag Inflate?

In a deployment event, the sensing system sends an electrical signal triggering a release of gas from the inflator. Gas from the inflator fills the airbag causing the bag to break out of the cover and deploy. The inflator, the airbag, and related hardware are all part of the airbag module.

Frontal airbag modules are located inside the steering wheel and instrument panel. For vehicles with seat-mounted side impact airbags, there are airbag modules in the side of the front seatbacks closest to the door.

## How Does an Airbag Restrain?

In moderate to severe frontal or near frontal collisions, even belted occupants can contact the steering wheel or the instrument panel. In moderate to severe side collisions, even belted occupants can contact the inside of the vehicle.

Airbags supplement the protection provided by safety belts. Frontal airbags distribute the force of the impact more evenly over the occupant's upper body, stopping the occupant more gradually. Seat-mounted side impact airbags distribute the force of the impact more evenly over the occupant's upper body.

But airbags would not help in many types of collisions, primarily because the occupant's motion is not toward those airbags. See *When Should an Airbag Inflate?* on page 1-42 for more information.

Airbags should never be regarded as anything more than a supplement to safety belts.

## What Will You See After an Airbag Inflates?

After the frontal and seat-mounted side impact airbags inflate, they quickly deflate, so quickly that some people may not even realize the airbags inflated. Some components of the airbag module may be hot for several minutes. For location of the airbag modules, see *What Makes an Airbag Inflate?* on page 1-43.

The parts of the airbag that come into contact with you may be warm, but not too hot to touch. There may be some smoke and dust coming from the vents in the deflated airbags. Airbag inflation does not prevent the driver from seeing out of the windshield or being able to steer the vehicle, nor does it prevent people from leaving the vehicle.

### CAUTION:

When an airbag inflates, there may be dust in the air. This dust could cause breathing problems for people with a history of asthma or other breathing trouble. To avoid this, everyone in the vehicle should get out as soon as it is safe to do so. If you have breathing problems but cannot get out of the vehicle after an airbag inflates, then get fresh air by opening a window or a door. If you experience breathing problems following an airbag deployment, you should seek medical attention.

The vehicle has a feature that may automatically unlock the doors, turn the interior lamps on, and turn on the hazard warning flashers when the airbags inflate. You can lock the doors, turn the interior lamps off, and turn the hazard warning flashers off by using the controls for those features.



In many crashes severe enough to inflate the airbag, windshields are broken by vehicle deformation. Additional windshield breakage may also occur from the right front passenger airbag.

- Airbags are designed to inflate only once. After an airbag inflates, you will need some new parts for the airbag system. If you do not get them, the airbag system will not be there to help protect you in another crash. A new system will include airbag modules and possibly other parts. The service manual for your vehicle covers the need to replace other parts.
- The vehicle has a crash sensing and diagnostic module which records information after a crash. See *Vehicle Data Recording and Privacy on page 8-16* and *Event Data Recorders on page 8-17*.
- Let only qualified technicians work on the airbag system. Improper service can mean that the airbag system will not work properly. See your dealer/retailer for service.

## Passenger Sensing System

The vehicle has a passenger sensing system for the right front passenger position. The passenger airbag status indicator will be visible in the rearview mirror when the vehicle is started.



**United States**

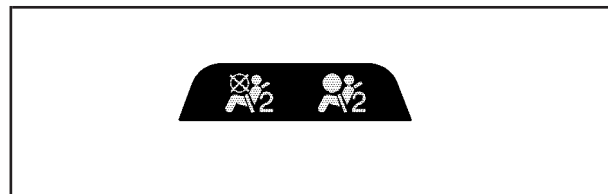

**Canada**

The words ON and OFF, or the symbol for on and off, will be visible during the system check. When the system check is complete, either the word ON or OFF, or the symbol for on or off, will be visible. See *Passenger Airbag Status Indicator on page 3-45*.

The passenger sensing system will turn off the right front passenger frontal airbag and seat-mounted side impact airbag under certain conditions. The driver airbags are not affected by the passenger sensing system.

The passenger sensing system works with sensors that are part of the right front passenger seat. The sensors are designed to detect the presence of a properly-seated occupant and determine if the right front passenger frontal airbag and seat-mounted side impact airbag should be enabled (may inflate) or not.

According to accident statistics, children are safer when properly secured in a rear seat in the correct child restraint for their weight and size. We recommend that rear-facing child restraints not be transported in the vehicle, even if the airbags are off.

A label on the sun visor says, "Never put a rear-facing child seat in the front." This is because the risk to the rear-facing child is so great, if the airbag deploys.

## **CAUTION:**

A child in a rear-facing child restraint can be seriously injured or killed if the right front passenger airbag inflates. This is because the back of the rear-facing child restraint would be very close to the inflating airbag. A child in a forward-facing child restraint can be seriously injured or killed if the right front passenger airbag inflates and the passenger seat is in a forward position.

Even if the passenger sensing system has turned off the right front passenger frontal airbag and seat-mounted side impact airbag (if equipped), no system is fail-safe. No one can guarantee that an airbag will not deploy under some unusual circumstance, even though the airbag(s) are off.

Secure rear-facing child restraints in a rear seat, even if the airbag(s) are off. If you secure a forward-facing child restraint in the right front seat, always move the front passenger seat as far back as it will go. It is better to secure the child restraint in a rear seat.

The passenger sensing system is designed to turn off the right front passenger frontal airbag and seat-mounted side impact airbag if:

- The right front passenger seat is unoccupied.
- The system determines that an infant is present in a rear-facing infant seat.
- The system determines that a small child is present in a child restraint.
- The system determines that a small child is present in a booster seat.
- A right front passenger takes his/her weight off of the seat for a period of time.
- The right front passenger seat is occupied by a smaller person, such as a child who has outgrown child restraints.
- Or, if there is a critical problem with the airbag system or the passenger sensing system.

When the passenger sensing system has turned off the right front passenger frontal airbag, and seat-mounted side impact airbag, the off indicator will light and stay lit to remind you that the airbag(s) are off. See *Passenger Airbag Status Indicator on page 3-45*.

The passenger sensing system is designed to turn on (may inflate) the right front passenger frontal airbag and seat-mounted side impact airbag anytime the system senses that a person of adult size is sitting properly in the right front passenger seat.

When the passenger sensing system has allowed the airbags to be enabled, the on indicator will light and stay lit to remind you that the airbags are active.

For some children who have outgrown child restraints and for very small adults, the passenger sensing system may or may not turn off the right front passenger frontal airbag and seat-mounted side impact airbag, depending upon the person's seating posture and body build.

Everyone in the vehicle who has outgrown child restraints should wear a safety belt properly — whether or not there is an airbag for that person.

### **CAUTION:**

If the airbag readiness light ever comes on and stays on, it means that something may be wrong with the airbag system. To help avoid injury to yourself or others, have the vehicle serviced right away. See *Airbag Readiness Light on page 3-44* for more information, including important safety information.

## If the On Indicator is Lit for a Child Restraint

If a child restraint has been installed and the on indicator is lit:

1. Turn the vehicle off.
2. Remove the child restraint from the vehicle.
3. Remove any additional items from the seat such as blankets, cushions, seat covers, seat heaters, or seat massagers.
4. Reinstall the child restraint following the directions provided by the child restraint manufacturer and refer to *Securing a Child Restraint in the Right Front Seat Position* on page 1-34.
5. If, after reinstalling the child restraint and restarting the vehicle, the on indicator is still lit, turn the vehicle off. Then slightly recline the vehicle seatback and adjust the seat cushion, if adjustable, to make sure that the vehicle seatback is not pushing the child restraint into the seat cushion.
6. Restart the vehicle.

The passenger sensing system may or may not turn off the airbag(s) for a child in a child restraint depending upon the child's seating posture and body build.

If the on indicator is still lit, do not install a child restraint in this vehicle and check with your dealer/retailer.

## If the Off Indicator is Lit for an Adult-Size Occupant



If a person of adult-size is sitting in the right front passenger seat, but the off indicator is lit, it could be because that person is not sitting properly in the seat.

If this happens, use the following steps to allow the system to detect that person and enable the right front passenger frontal airbag and seat-mounted side impact airbag:

1. Turn the vehicle off.
2. Remove any additional material from the seat, such as blankets, cushions, seat covers, seat heaters, or seat massagers.
3. Place the seatback in the fully upright position.
4. Have the person sit upright in the seat, centered on the seat cushion, with legs comfortably extended.
5. Restart the vehicle and have the person remain in this position for two to three minutes after the on indicator is lit.

## Additional Factors Affecting System Operation

Safety belts help keep the passenger in position on the seat during vehicle maneuvers and braking, which helps the passenger sensing system maintain the passenger airbag status. See “Safety Belts” and “Child Restraints” in the Index for additional information about the importance of proper restraint use.

If the shoulder portion of the belt is pulled out all the way, the child restraint locking feature will be engaged. This may unintentionally cause the passenger sensing system to turn the airbag(s) off for some adult size occupants. If this happens, let the belt go back all the way and start again.

A thick layer of additional material, such as a blanket or cushion, or aftermarket equipment such as seat covers, seat heaters, and seat massagers can affect how well the passenger sensing system operates. We recommend that you not use seat covers or other aftermarket equipment except when approved by GM for your specific vehicle. See *Adding Equipment to Your Airbag-Equipped Vehicle* on page 1-50 for more information about modifications that can affect how the system operates.

### CAUTION:

Stowing of articles under the passenger seat or between the passenger seat cushion and seatback may interfere with the proper operation of the passenger sensing system.

## Servicing Your Airbag-Equipped Vehicle

Airbags affect how the vehicle should be serviced. There are parts of the airbag system in several places around the vehicle. Your dealer/retailer and the service manual have information about servicing the vehicle and the airbag system. To purchase a service manual, see *Service Publications Ordering Information on page 8-15*.

### **CAUTION:**

For up to 10 seconds after the ignition is turned off and the battery is disconnected, an airbag can still inflate during improper service. You can be injured if you are close to an airbag when it inflates. Avoid yellow connectors. They are probably part of the airbag system. Be sure to follow proper service procedures, and make sure the person performing work for you is qualified to do so.

## Adding Equipment to Your Airbag-Equipped Vehicle

- Q:** Is there anything I might add to or change about the vehicle that could keep the airbags from working properly?
- A:** Yes. If you add things that change your vehicle's frame, bumper system, height, front end or side sheet metal, they may keep the airbag system from working properly. Changing or moving any parts of the front seats, safety belts, the airbag sensing and diagnostic module, steering wheel, instrument panel, the inside review mirror, front sensors, or airbag wiring can affect the operation of the airbag system.
- In addition, the vehicle has a passenger sensing system for the right front passenger position, which includes sensors that are part of the passenger seat.

The passenger sensing system may not operate properly if the original seat trim is replaced with non-GM covers, upholstery or trim, or with GM covers, upholstery or trim designed for a different vehicle. Any object, such as an aftermarket seat heater or a comfort enhancing pad or device, installed under or on top of the seat fabric, could also interfere with the operation of the passenger sensing system. This could either prevent proper deployment of the passenger airbag(s) or prevent the passenger sensing system from properly turning off the passenger airbag(s). See *Passenger Sensing System on page 1-45*.

If you have any questions about this, you should contact Customer Assistance before you modify your vehicle. The phone numbers and addresses for Customer Assistance are in Step Two of the Customer Satisfaction Procedure in this manual. See *Customer Satisfaction Procedure on page 8-2*.

**Q: Because I have a disability, I have to get my vehicle modified. How can I find out whether this will affect my airbag system?**

**A:** If you have questions, call Customer Assistance. The phone numbers and addresses for Customer Assistance are in Step Two of the Customer Satisfaction Procedure in this manual. See *Customer Satisfaction Procedure on page 8-2*.

Your dealer/retailer and the service manual have information about the location of the airbag sensors, sensing and diagnostic module and airbag wiring.

# Restraint System Check

## Checking the Restraint Systems

### Safety Belts

Now and then, check the safety belt reminder light, safety belts, buckles, latch plates, retractors, and anchorages are all working properly.

Look for any other loose or damaged safety belt system parts that might keep a safety belt system from doing its job. See your dealer/retailer to have it repaired. Torn or frayed safety belts may not protect you in a crash. They can rip apart under impact forces. If a belt is torn or frayed, get a new one right away.

Make sure the safety belt reminder light is working. See *Safety Belt Reminders on page 3-44* for more information.

Keep safety belts clean and dry. See *Care of Safety Belts on page 6-76*.

### Airbags

The airbag system does not need regularly scheduled maintenance or replacement. Make sure the airbag readiness light is working. See *Airbag Readiness Light on page 3-44* for more information.

**Notice:** If an airbag covering is damaged, opened, or broken, the airbag may not work properly. Do not open or break the airbag coverings. If there are any opened or broken airbag covers, have the airbag covering and/or airbag module replaced. For the location of the airbag modules, see *What Makes an Airbag Inflate? on page 1-43*. See your dealer/retailer for service.



## Replacing Restraint System Parts After a Crash

### CAUTION:

A crash can damage the restraint systems in your vehicle. A damaged restraint system may not properly protect the person using it, resulting in serious injury or even death in a crash. To help make sure your restraint systems are working properly after a crash, have them inspected and any necessary replacements made as soon as possible.

If you have had a crash, do you need new belts?

After a very minor crash, nothing may be necessary. But the belt assemblies that were used during any crash may have been stressed or damaged. See your dealer/retailer to have your safety belt assemblies inspected or replaced.

New parts and repairs may be necessary even if the belt was not being used at the time of the crash.

If an airbag inflates, you will need to replace airbag system parts. See the part on the airbag system earlier in this section.

Have your safety belt pretensioners checked if your vehicle has been in a crash, or if your airbag readiness light stays on after you start your vehicle or while you are driving. See *Airbag Readiness Light* on page 3-44.



## Section 2 Features and Controls

---

<b>Keys</b> .....	2-3	<b>Starting and Operating Your Vehicle</b> .....	2-24
Keyless Access System .....	2-4	New Vehicle Break-In .....	2-24
Keyless Access System Operation .....	2-5	Ignition Positions .....	2-24
<b>Doors and Locks</b> .....	2-10	Retained Accessory Power (RAP) .....	2-25
Door Locks .....	2-10	Starting the Engine .....	2-26
Power Door Locks .....	2-13	Automatic Transmission Operation .....	2-28
Automatic Door Lock .....	2-13	Parking Brake .....	2-32
Programmable Automatic Door Unlock .....	2-13	Shifting Into Park .....	2-33
Lockout Protection .....	2-13	Shifting Out of Park .....	2-35
Trunk .....	2-14	Parking Over Things That Burn .....	2-35
<b>Windows</b> .....	2-17	Engine Exhaust .....	2-36
Power Windows .....	2-18	Running the Vehicle While Parked .....	2-37
Sun Visors .....	2-20	<b>Mirrors</b> .....	2-38
<b>Theft-Deterrent Systems</b> .....	2-20	Automatic Dimming Rearview Mirror .....	2-38
Theft-Deterrent System .....	2-20	Outside Power Mirrors .....	2-38
Valet Lockout Switch .....	2-22	Outside Automatic Dimming Mirror .....	2-39
Immobilizer .....	2-22	Park Assist Mirror .....	2-39
Immobilizer Operation .....	2-23	Outside Convex Mirror .....	2-39
		Outside Heated Mirrors .....	2-39

## Section 2 Features and Controls

---

<b>Object Detection Systems</b> .....	2-40	Center Console Storage .....	2-53
Ultrasonic Rear Parking Assist (URPA) .....	2-40	Floor Mats .....	2-53
<b>OnStar® System</b> .....	2-42	Rear Storage Area .....	2-54
<b>Universal Home Remote System</b> .....	2-45	Convenience Net .....	2-54
Universal Home Remote System Operation .....	2-46	<b>Retractable Hardtop</b> .....	2-54
<b>Storage Areas</b> .....	2-53	Lowering the Retractable Hardtop .....	2-55
Glove Box .....	2-53	Raising the Retractable Hardtop .....	2-56
Cupholders .....	2-53		

## Keys

### CAUTION:

Leaving children in a vehicle with the keyless access transmitter is dangerous for many reasons, children or others could be badly injured or even killed. They could operate the power windows or other controls or even make the vehicle move. The windows will function with the keyless access transmitter in the vehicle and they could be seriously injured or killed if caught in the path of a closing window. Do not leave the keyless access transmitter in a vehicle with children.

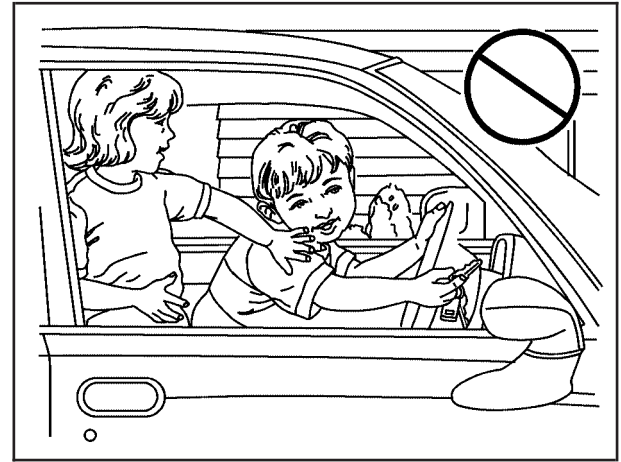

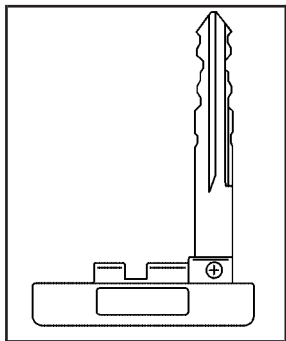

This key, located inside the keyless access transmitter, can be used for the glove box and the trunk, if vehicle power is lost. See *Trunk* on page 2-14 for more information.

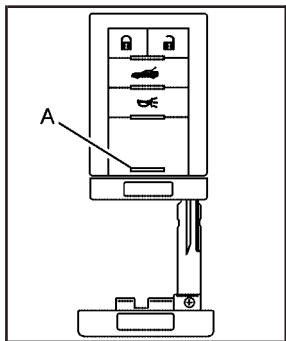

To remove the key, press the button (A) near the bottom of the keyless access transmitter, and pull the key out. Never pull the key out without pressing the button.

Your vehicle has a keyless access system with pushbutton start. See *Ignition Positions* on page 2-24 for information on starting the vehicle.

**Notice:** If you ever lose your transmitter(s) and/or key, it could be difficult to get into your vehicle. You may even have to damage your vehicle to get in. Be sure you have a spare transmitter and/or key.

In an emergency, contact Cadillac Roadside Assistance. See *Roadside Service* on page 8-7.

## Keyless Access System

The Keyless Access System operates on a radio frequency subject to Federal Communications Commission (FCC) Rules and with Industry Canada.

This device complies with Part 15 of the FCC Rules. Operation is subject to the following two conditions:

1. This device may not cause harmful interference.
2. This device must accept any interference received, including interference that may cause undesired operation.

This device complies with RSS-210 of Industry Canada. Operation is subject to the following two conditions:

1. This device may not cause interference.
2. This device must accept any interference received, including interference that may cause undesired operation of the device.

Changes or modifications to this system by other than an authorized service facility could void authorization to use this equipment.

If there is a decrease in the keyless access transmitter range, try this:

- Check the distance. The transmitter may be too far from the vehicle. It may be necessary to stand closer during rainy or snowy weather.
- Check the location. Other vehicles or objects may be blocking the signal. Take a few steps to the left or right, hold the transmitter higher, and try again.
- Check the transmitter's battery. See "Battery Replacement" under *Keyless Access System Operation on page 2-5*.
- Make sure that an electronic device such as a cellular phone or lap top computer is not causing interference.
- If the transmitter is still not working correctly, see your dealer/retailer or a qualified technician for service.

## Keyless Access System Operation

The Keyless Access System transmitter functions work up to 100 feet (30 m) away from the vehicle.

### Keyless Unlocking

Press the door handle sensor to unlock and open the doors if the keyless access transmitter is within range. See *Door Locks on page 2-10* and "Passive Unlocking" under *DIC Vehicle Personalization on page 3-72* for additional information.

### Keyless Locking

The doors lock after several seconds if all doors are closed and at least one keyless access transmitter has been removed from the interior of the vehicle. To customize whether the doors automatically lock when exiting the vehicle, see "Passive Locking" under *DIC Vehicle Personalization on page 3-72* for additional information.

## Keyless Trunk Opening

Press the trunk release sensor, located on the rear of the trunk lid under the emblem, to open the trunk if the keyless access transmitter is within range. See *Trunk* on page 2-14 for additional information.

There are other conditions which can affect the performance of the transmitter. See *Keyless Access System* on page 2-4.

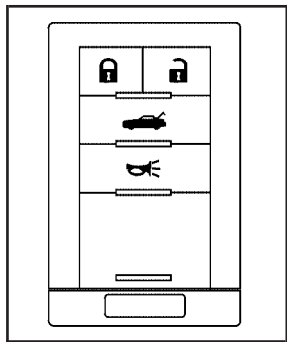

This vehicle comes with two transmitters.

**Lock** (padlock icon): Press to lock the doors. The indicator light on the door flashes once. If the padlock icon is pressed twice, the doors lock, the light flashes once and the horn sounds once.

**Unlock** (open padlock icon): Press once to unlock the driver door. The indicator light on the door flashes twice. Press the open padlock icon twice within five seconds to unlock both doors. The interior lamps may come on.

Pressing the padlock icon also recalls the memory settings. See *Memory Seat, Mirrors and Steering Wheel* on page 1-3 for more information.

**Trunk** (car icon): Press and hold for about one second to open the trunk. If the engine is running, the shift lever must be in P (Park).

**Panic** (flashing horn icon): Press to sound the vehicle alarm. Press any other button on the keyless access transmitter to stop the vehicle alarm.

The vehicle comes with two transmitters. Each transmitter will have a number on top of it, "1" or "2". These numbers correspond to the driver of the vehicle. For example, the memory seat position for driver 1 will be recalled when using the transmitter labeled "1", if enabled through the vehicle personalization. See *Memory Seat, Mirrors and Steering Wheel* on page 1-3 and *DIC Vehicle Personalization* on page 3-72.

## Programming Transmitters to the Vehicle

Only keyless access transmitters programmed to this vehicle will work. If a transmitter is lost or stolen, a replacement can be purchased and programmed through your dealer/retailer. The vehicle can be reprogrammed so that lost or stolen transmitters no longer work. Each vehicle can have up to four transmitters programmed to it.



## Programming with a Recognized Transmitter

A new transmitter can be programmed to the vehicle when there is one recognized transmitter. For vehicles sold in Canada, two recognized transmitters are required to program a new transmitter.

1. The vehicle must be off.
2. Both the recognized and new transmitters must be with you.
3. Insert the vehicle key into the key cylinder located on the lower rear fascia on the driver side of the vehicle. See *Trunk on page 2-14* for more information on the key cylinder.
4. Open the trunk.
5. Turn the key five times within five seconds.
6. The Driver Information Center (DIC) displays READY FOR FOB # 2, 3 or 4.

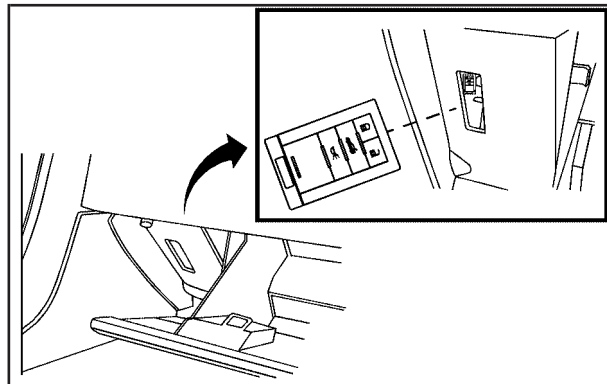

7. Place the new transmitter in the glove box transmitter pocket with the buttons facing the passenger side.

8. A beep sounds once programming is complete. The DIC will display READY FOR #3 or 4, or MAX # FOBS LEARNED.
9. To program additional transmitters, repeat Step 7. Press Acc. on the ignition switch if programming is complete.
10. Press  on each newly programmed transmitter to complete the process.

### Programming without a Recognized Transmitter

This procedure requires three ten minutes cycles to complete the programming process. United States owners are permitted to program a new transmitter to their vehicle when a recognized transmitter is not available. The Canadian immobilizer standard requires that Canadian owners see their dealer/retailer for programming new transmitters when two recognized transmitters are not available.

1. The vehicle must be off.

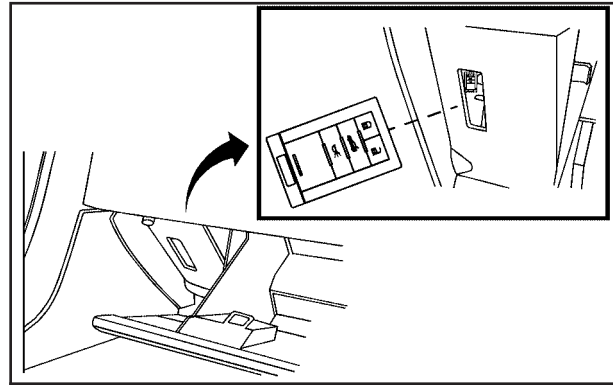

2. Place the new transmitter in the glove box transmitter pocket with the buttons facing the passenger side.
3. Insert the vehicle key into the key cylinder located on the lower rear fascia on the driver side of the vehicle. See *Trunk* on page 2-14 for more information on the key cylinder.
4. Open the trunk.
5. Turn the key five times within five seconds.
6. The DIC message displays OFF-ACC TO LEARN.

7. Press Acc. on the ignition switch.
8. The DIC reads WAIT 10 MINUTES and counts down to zero.
9. The DIC displays OFF-ACC TO LEARN again.
10. Press Acc. on the ignition switch.
11. Steps 8, 9 and 10 will be repeated two more times.
12. A beep sounds and the DIC reads READY FOR FOB #1. All previously known transmitter programming has been erased.
13. A beep sounds once programming is complete. The DIC displays READY FOR FOB #2.  
To program additional transmitters, take transmitter 1 out of the transmitter pocket and place transmitter 2 in the pocket. Up to four transmitters can be programmed. The DIC then displays MAXIMUM NUMBER OF FOBS LEARNED and exits the programming mode.  
Press Acc. on the ignition switch to complete the process.

14. Press Acc. on the ignition switch if programming is complete.
15. Press  on each newly programmed transmitter to complete the process.

## Starting the Vehicle with a Low Transmitter Battery

If the transmitter battery is weak, the DIC may display NO FOB DETECTED when trying to start the vehicle. To start the vehicle, place the transmitter in the glove box transmitter pocket with the buttons facing the passenger side. Then, with the vehicle in P (Park) or N (Neutral), press the brake pedal and . Replace the transmitter battery as soon as possible. Change the transmitter battery if the DIC displays FOB BATTERY LOW.

## Battery Replacement

**Notice:** When replacing the battery, do not touch any of the circuitry on the transmitter. Static from your body could damage the transmitter.

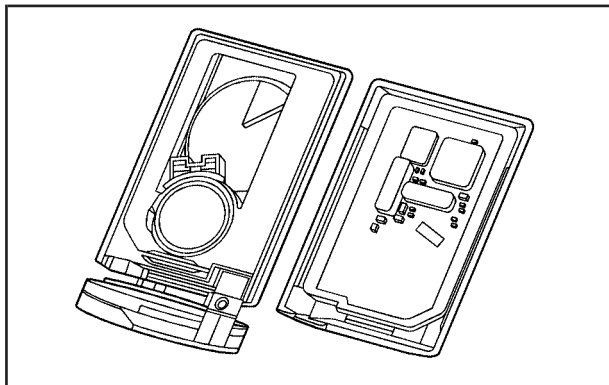

1. Separate the transmitter with a flat, thin object inserted into the slot on the side of the transmitter.
2. Remove the old battery. Do not use a metal object.
3. Insert the new battery, positive side facing down. Replace with a CR2032 or equivalent battery.
4. Snap the transmitter back together.

## Doors and Locks

### Door Locks

#### CAUTION:

Unlocked doors can be dangerous.

- Passengers — especially children — can easily open the doors and fall out of a moving vehicle. When a door is locked it will not open. You increase the chance of being thrown out of the vehicle in a crash if the doors are not locked. So, wear safety belts properly and lock the doors whenever you drive.
- Young children who get into unlocked vehicles may be unable to get out. A child can be overcome by extreme heat and can suffer permanent injuries or even death from heat stroke. Always lock your vehicle whenever you leave it.
- Outsiders can easily enter through an unlocked door when you slow down or stop your vehicle. Locking your doors can help prevent this from happening.

To lock or unlock your vehicle from the outside, use the keyless access transmitter and press the appropriate lock or unlock button. You may also unlock and open the door passively when you squeeze the door handle sensor, as long as you have your transmitter with you. Passive entry occurs when the door handle sensor is pressed and the vehicle recognizes your keyless access transmitter. When the passenger door is opened first, the driver door will also become unlocked.

From the inside, use the power door lock buttons located at the top of the door panel near the window. See *Power Door Locks on page 2-13* for more information.

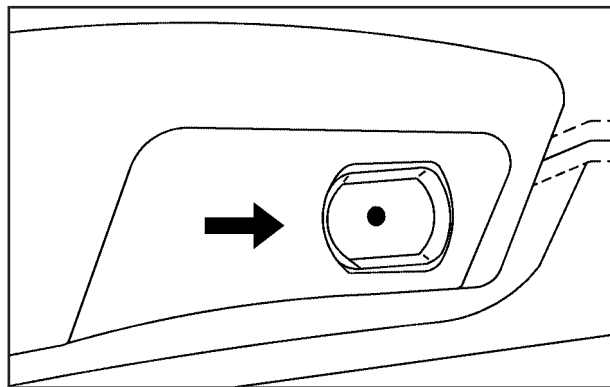

To open a door from the inside, press the button in front of the door handle and push the door open.

If power to the vehicle or the keyless access transmitter is lost, there are two ways to open the door.

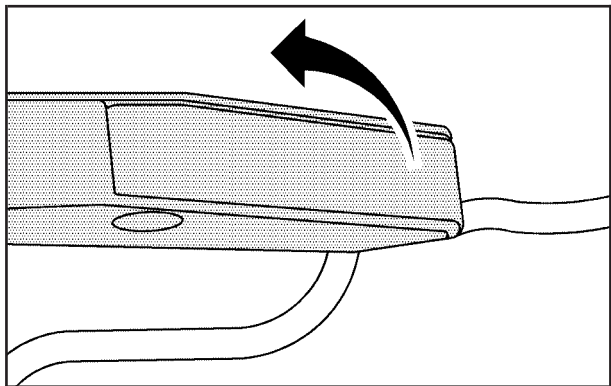

If you are inside the vehicle, use the door release handle located on the floor next to each seat. Pull the handle up to unlock and unlatch the door.

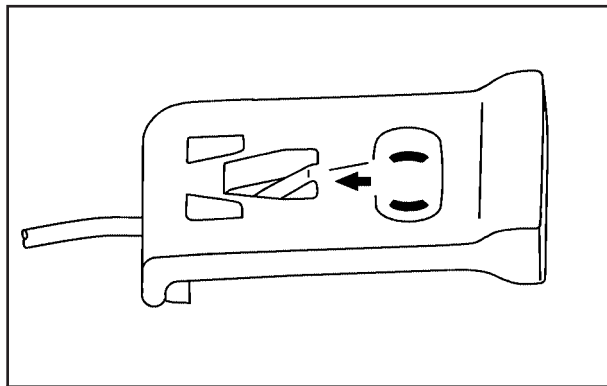

If you are outside the vehicle, there is a door release tab in the trunk. The tab is located behind a panel on the driver side of the trunk. Pull the handle to unlock and unlatch the driver door. See *Trunk* on page 2-14 for information on opening the trunk during a loss of power.

## Power Door Locks

The power door lock switches are located on the doors.

There is an indicator light on the rear of the door near the window.

 **(Unlock):** Press to unlock the doors.

When pressed, a beep sounds. If the door is closed when pressed, the light flashes twice. If the door is open when pressed, the light flashes.

 **(Lock):** Press to lock the doors.

When pressed, a beep sounds. If the door is closed when pressed, the light comes on for a few seconds, then turns off. If the door is open when pressed, the light stays on.

## Automatic Door Lock

Your vehicle is programmed so that, when the doors are closed, the ignition is on and the shift lever is moved out of P (Park), all the doors will lock.

If someone needs to get out while the vehicle is not in P (Park), have the person use the power door unlock switch. When the door is closed again, the doors will lock either when your foot is removed from the brake or the vehicle speed becomes faster than 8 mph (13 km/h).

## Programmable Automatic Door Unlock

Your vehicle is programmed so that, when the shift lever is moved into P (Park), both doors will unlock.

With the vehicle in P (Park) and the engine running, door unlocking can be programmed through prompts displayed on the Driver Information Center (DIC). These prompts allow the driver to choose various unlock settings. For programming information, see *DIC Vehicle Personalization on page 3-72*.

## Lockout Protection

Your vehicle can be programmed to sound the horn three times and unlock the driver door when both doors are closed and there is a keyless access transmitter inside the vehicle. When the driver door is opened, a reminder chime will sound continuously. The vehicle will remain locked only when at least one transmitter has been removed from the vehicle and both doors are closed. See *DIC Vehicle Personalization on page 3-72*.

## Trunk

### CAUTION:

Exhaust gases may enter the vehicle if it is driven with the liftgate, trunk/hatch open, or with any objects that pass through the seal between the body and the trunk/hatch or liftgate. Engine exhaust contains Carbon Monoxide (CO) which cannot be seen or smelled. It can cause unconsciousness and even death.

If the vehicle must be driven with the liftgate, or trunk/hatch open:

- Close all of the windows
- Fully open the air outlets on or under the instrument panel
- Adjust the Climate Control system to a setting that brings in only outside air and set the fan speed to the highest setting. See Climate Control System in the Index.
- If the vehicle is equipped with a power liftgate, disable the power liftgate function.

For more information about carbon monoxide, see Engine Exhaust *Engine Exhaust on page 2-36*.

## Trunk Lock Release

### CAUTION:

Moving parts of the powered trunk lid can be dangerous. You or others could be injured. Keep yourself and others away from the trunk lid and its mechanism while it is closing.

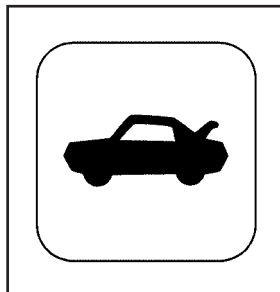

This button is located to the left of the steering wheel on the instrument panel.

Press to open the trunk. To use, the vehicle must be in P (Park) or N (Neutral) and the valet lockout switch must be off.



You can also press  on the keyless access transmitter to open the trunk. To disable this feature, see “Valet Lockout Switch” under *Theft-Deterrent Systems* on page 2-20.

You may passively enter the trunk when you squeeze the trunk release sensor located on the rear of the trunk lid under the emblem, as long as you have your transmitter with you. The vehicle must be in PARK (P) and the valet lockout switch must be off. See *Valet Lockout Switch* on page 2-22.

To close the trunk, press  on the underside of the trunk lid.

To stop the trunk lid while it is closing, do one of the following:

- Press the trunk lock release button located on the instrument panel.
- Use the vehicle key.

- Squeeze the trunk release sensor located on the rear of the trunk lid.
- Press  on the keyless access transmitter.
- Press the trunk close button on the underside of the trunk lid.

To begin opening the trunk from the stopped position, use any of the methods above, except pressing the trunk close button.

To resume closing the power trunk lid, press the trunk close button on the underside of the trunk lid.

If the vehicle has lost battery power, you can still open the trunk using the vehicle key. See *Keys* on page 2-3 for more information.

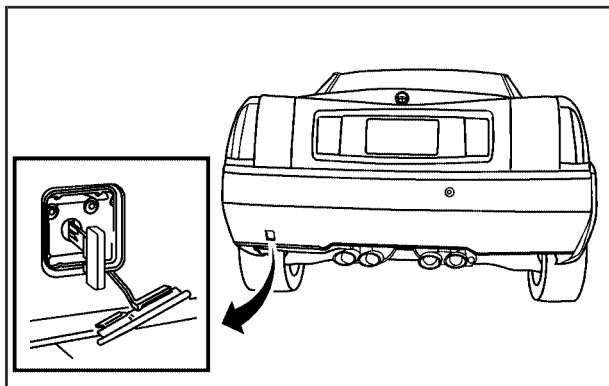

The key cylinder is located behind a cover on the lower rear fascia on the driver side of the vehicle. Open the door to access the key cylinder.

## Emergency Trunk Release Handle

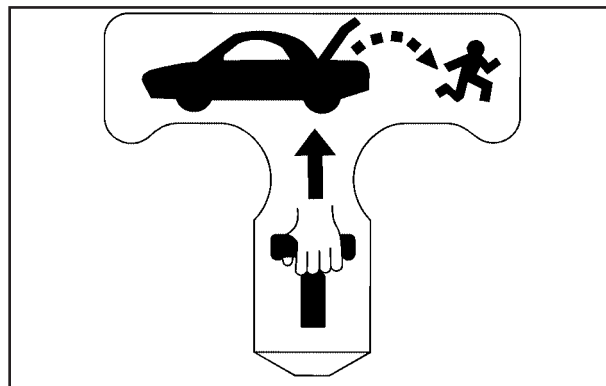

**Notice:** Do not use the emergency trunk release handle as a tie-down or anchor point when securing items in the trunk as it could damage the handle.

There is a glow-in-the-dark emergency trunk release handle located inside the trunk near the latch. This handle will glow following exposure to light. Pull the release handle and push up on the trunk lid to release the latch from the inside.

# Windows

## CAUTION:

Leaving children, helpless adults, or pets in a vehicle with the windows closed is dangerous. They can be overcome by the extreme heat and suffer permanent injuries or even death from heat stroke. Never leave a child, a helpless adult, or a pet alone in a vehicle, especially with the windows closed in warm or hot weather.

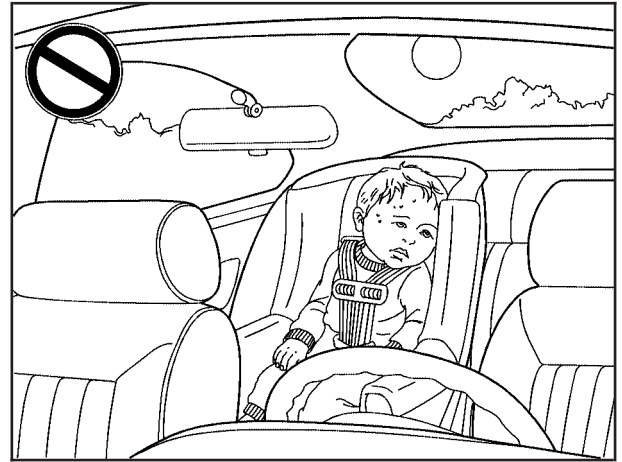

## Power Windows

### CAUTION:

Leaving children in a vehicle with the keys is dangerous for many reasons, children or others could be badly injured or even killed. They could operate the power windows or other controls or even make the vehicle move. The windows will function and they could be seriously injured or killed if caught in the path of a closing window. Do not leave keys in a vehicle with children.

When there are children in the rear seat use the window lockout button to prevent unintentional operation of the windows.

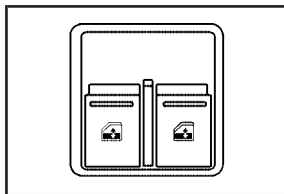

The power window switches are located on each door near the armrest.

Press the front of the switch to the first position to open the window to the desired level. Lift the front of the switch to the first position to close the window.

The vehicle has Retained Accessory Power (RAP) that allows power windows to be used once the ignition has been turned off. For more information, see *Retained Accessory Power (RAP)* on page 2-25.

### Power Window Initialize

After a power reconnect such as battery replacement, the express-up and index-up features will not function until the system is initialized. Once power is restored, do the following:

1. Close the door.
2. Raise the window by lifting the front of the power window switch.
3. Lift the switch for three seconds after the window is closed. Release the switch. Then lift the switch again for three seconds.

The express-up system must be initialized to operate the windows with the door open.

## Express Window

**Down:** Press the front of the window switch to the second position and release to activate the express-down feature. To stop the window, briefly lift the switch.

**Up:** Lift the front of the switch briefly to activate the express-up feature. To stop the window, briefly press the switch.

## Express-Up Window

This feature is on both power windows. Press the up arrow on the switch to the second position to activate the express-up feature. If you want to stop the window as it is raising, press the switch again.

## Express Window Anti-Pinch Feature

If any object is in the path of the window when the express-up is active, the window will stop at the obstruction and auto-reverse to a preset factory position. Weather conditions such as severe icing may also cause the window to auto-reverse. The window will return to normal operation once the obstruction or condition is removed.

### CAUTION:

If express override is activated, the window will not reverse automatically. You or others could be injured and the window could be damaged. Before you use express override, make sure that all people and obstructions are clear of the window path.

## Express Window Anti-Pinch Override

In an emergency, the anti-pinch feature can be overridden in a supervised mode. Hold the window switch all the way down in the express position. The window will rise for as long as the switch is held. Once the switch is released, the express mode is re-activated.

In this mode, the window can still close on an object in its path. Use care when using the override mode.

## Window Indexing

This feature automatically lowers the window a small amount when the door is opened. Then, when the door is closed, the window will raise to its full up position.

## Sun Visors

**Notice:** Raising or lowering the retractable hardtop with the visor or the visor vanity mirror cover up may cause damage to the visor or mirror cover. Always return the visor to the center mount or lower the cover on the visor vanity mirror before raising or lowering the retractable hardtop.

Swing down the visor to block out glare. It can also be detached from the center mount and moved to the side.

## Lighted Visor Vanity Mirrors

Swing the visor down and lift the cover. The lamp will automatically come on when the cover is opened.

## Theft-Deterrent Systems

Vehicle theft is big business, especially in some cities. This vehicle has theft-deterrent features, however, they do not make it impossible to steal.

### Theft-Deterrent System

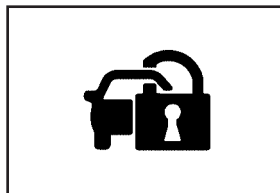

With this system, the security light will flash when the door is open and locked with the power door lock switch.

If this light is on continuously while the engine is running, your vehicle needs service.

## Arming the System

To arm the system:

- Press  on the keyless access transmitter.
- Open the door. Lock the door with the power door lock switch. The security light should flash. Remove the keyless access transmitter from the interior of the vehicle and close the door. The security light will stop flashing and stay on. After 30 seconds, the light should turn off.

The vehicle can be programmed to automatically lock the doors and arm the system when you exit the vehicle. See *DIC Vehicle Personalization on page 3-72*.

Now, if a door or the trunk lid is opened without the keyless access transmitter, the alarm will go off. The horn will sound for two minutes, then it will go off to save battery power. And, the vehicle will not start without a keyless transmitter present.

The theft-deterrent system will not arm if you lock the driver door with the power door lock switch after the doors are closed.

If the passenger stays in the vehicle when you leave with the keyless access transmitter, have the passenger lock the vehicle after the doors are closed. This way the alarm will not arm, and the passenger will not set it off.



## Testing the Alarm

To test the system:

1. Close the trunk lid.
2. Lower the window on the driver door.
3. Manually arm the system.
4. Close the doors and wait 30 seconds.
5. Reach through the open window and manually pull the release lever on the floor.
6. Turn off the alarm by pressing  on the transmitter.

If the alarm is inoperative, check to see if the horn works. If not, check the horn fuse. See *Fuses and Circuit Breakers on page 6-83*. If the horn works, but the alarm doesn't go off, see your dealer/retailer.

## Disarming the System

Always use the keyless access transmitter to unlock a door either by pressing  on the transmitter or by squeezing the door handle sensor while you have the transmitter with you. Unlocking a door any other way will set off the alarm. If the alarm sounds, press  on the keyless access transmitter to disarm it.

Do not leave the key or device that disarms or deactivates the theft deterrent system in the vehicle.

## Valet Lockout Switch

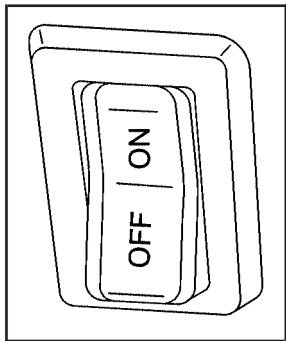

This switch is located inside the glove box.

Press ON to disable the use of the trunk and convertible top. The trunk cannot be opened except by using the key if the valet lockout is on.

Press OFF to enable the use of the trunk and convertible top.

Locking the glove box with the key will also help to secure the vehicle.

## Immobilizer

This device complies with Part 15 of the FCC Rules. Operation is subject to the following two conditions:

1. This device may not cause interference.
2. This device must accept any interference received, including interference that may cause undesired operation.

This device complies with RSS-210 of Industry Canada. Operation is subject to the following two conditions:

1. This device may not cause interference.
2. This device must accept any interference received, including interference that may cause undesired operation of the device.

Changes or modifications to this system by other than an authorized service facility could void authorization to use this equipment.



## Immobilizer Operation

The vehicle has a passive theft-deterrent system.

The system is automatically armed when the ignition is turned off.

The immobilization system is disarmed when the ignition is turned to OFF/ACCESSORY or START and a valid transmitter is found in the vehicle.

You do not have to manually arm or disarm the system.

The security light comes on if there is a problem with arming or disarming the theft-deterrent system.

The system has one or more keyless access transmitters that are matched to an immobilizer control unit in the vehicle. Only a correctly matched keyless access transmitter starts the vehicle. The vehicle may not start if the keyless access transmitter is damaged.

If the engine does not start and the security light comes on, there may be a problem with the immobilizer system. Press the START button again.

If the vehicle does not start and the keyless access transmitter appears to be undamaged, try another keyless access transmitter. Or, place the transmitter in the transmitter pocket. See “NO FOBS DETECTED” under *DIC Warnings and Messages on page 3-60* for additional information. Check the fuse. See *Fuses and Circuit Breakers on page 6-83*. If the engine still does not start with the other transmitter, the vehicle needs service. If the engine does start, the first transmitter may be faulty. See your dealer/retailer or have a new keyless access transmitter programmed to the vehicle.

The immobilizer system can learn new or replacement keyless access transmitters. Up to four keyless access transmitters can be programmed for the vehicle. To program additional transmitters, see “Matching transmitter(s) to Your Vehicle” under *Keyless Access System Operation on page 2-5*.

Do not leave the key or device that disarms or deactivates the theft deterrent system in the vehicle.

# Starting and Operating Your Vehicle

## New Vehicle Break-In

**Notice:** Your vehicle does not need an elaborate break-in. But it will perform better in the long run if you follow these guidelines:

- Keep your speed at 55 mph (88 km/h) or less for the first 500 miles (805 km).
- Do not drive at any one constant speed, fast or slow, for the first 500 miles (805 km). Do not make full-throttle starts. Avoid downshifting to brake or slow the vehicle.
- Avoid making hard stops for the first 200 miles (322 km) or so. During this time the new brake linings are not yet broken in. Hard stops with new linings can mean premature wear and earlier replacement. Follow this breaking-in guideline every time you get new brake linings.

Following break-in, engine speed and load can be gradually increased.

## Ignition Positions

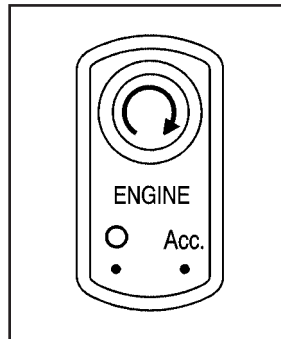

The vehicle has an electronic keyless ignition with push-button start.

In order to shift out of P (Park), the vehicle must be running or in OFF/ACCESSORY mode and the regular brake pedal must be applied.

**⌚ (START):** Press while your foot is on the brake to start the engine. The shifter must be in P (Park) or N (Neutral) to start the engine and the keyless access transmitter must be in the vehicle for the ignition to work.

○ **Acc. (OFF/ACCESSORY):** When this button is pressed, the engine will turn off even if the shifter is not in P (Park). If the shifter is in P (Park), the ignition mode will change to Retained Accessory Power (RAP), if all doors are closed. The ignition mode will change to off, if a front door is opened. See *Retained Accessory Power (RAP) on page 2-25* for more information. If the shifter is not in P (Park), the ignition mode will change to Acc. See *Shifting Into Park on page 2-33*.

When the engine is off, press this button to place the vehicle in accessory mode. ACCESSORY MODE ON will display on the Driver Information Center (DIC). This mode allows you to use things like the radio and the windshield wipers while the engine is off. Use accessory mode if you must have the vehicle in motion while the engine is off, for example, if the vehicle is being towed. If the door is open while in accessory mode, the key in reminder chime will sound continuously.

If the push-button start is not working, the vehicle may be near a strong radio antenna signal causing interference to the keyless access system. See *DIC Warnings and Messages on page 3-60* for more information.

After being in ACCESSORY mode for about 20 minutes, the vehicle will automatically enter RAP or will turn off, depending on if the doors are opened or closed.

## Retained Accessory Power (RAP)

Power to the following accessories continues to work for up to 10 minutes after the engine is turned off or until a door is opened:

- Audio System
- Audio Steering Wheel Controls
- Power Windows

For an additional 10 minutes of operation, close all the doors and press the Acc. button to place the vehicle in accessory mode. Press the button again to return to RAP.

## Starting the Engine

To place the transmission in the proper gear:

Move the shift lever to P (Park) or N (Neutral). To restart the engine when the vehicle is already moving, use N (Neutral).

**Notice:** Do not try to shift to P (Park) if the vehicle is moving. If you do, you could damage the transmission. Shift to P (Park) only when the vehicle is stopped.

The keyless access transmitter must be inside the vehicle for the ignition to work.

Cell phone chargers can interfere with the operation of the Keyless Access System. Battery chargers should not be plugged in when starting or turning off the engine.

To start the vehicle, do the following:

### Starting Procedure

1. With your foot on the brake pedal, press the START button located on the instrument panel.  
If there is not a keyless access transmitter in the vehicle or if there is something causing interference with it, the DIC will display NO FOBS DETECTED. See *DIC Warnings and Messages on page 3-60* for more information.

2. When the engine begins cranking, let go of the button and the engine cranks automatically until it starts. If the battery in the keyless access transmitter is weak, the DIC displays KEY FOB BATTERY LOW. You can still drive the vehicle.  
See “Battery Replacement” under *Keyless Access System Operation on page 2-5* for more information. If the fob battery is dead, you need to insert the fob into the fob slot to enable engine starting. See “No Fobs Detected” under *DIC Warnings and Messages on page 3-60*.
3. Do not race the engine immediately after starting it. Operate the engine and transmission gently until the oil warms up and lubricates all moving parts.
4. If the engine does not start and no DIC message is displayed, wait 15 seconds before trying again to let the cranking motor cool down.  
If the engine does not start after 5-10 seconds, especially in very cold weather (below 0°F or -18°C), it could be flooded with too much gasoline. Try pushing the accelerator pedal all the way to the floor while cranking for up to 15 seconds maximum.

**Notice:** Cranking the engine for long periods of time, by pressing the START button immediately after cranking has ended, can overheat and damage the cranking motor, and drain the battery. Wait at least 15 seconds between each try, to allow the cranking motor to cool down.

When the engine starts, let go of the accelerator. If the vehicle starts briefly but then stops again, do the same thing. This clears the extra gasoline from the engine.

The vehicle has a Computer-Controlled Cranking System. This feature assists in starting the engine and protects components. Once cranking has been initiated, the engine continues cranking for a few seconds or until the vehicle starts. If the engine does not start, cranking automatically stops after 15 seconds to prevent cranking motor damage. To prevent gear damage, this system also prevents cranking if the engine is already running.

**Notice:** The engine is designed to work with the electronics in the vehicle. If you add electrical parts or accessories, you could change the way the engine operates. Before adding electrical equipment, check with your dealer/retailer. If you do not, the engine might not perform properly. Any resulting damage would not be covered by the vehicle warranty.

## Stopping the Engine

Move the shift lever to P (Park) and press the Acc. button located on the instrument panel. If the shifter is not in P (Park), the engine shuts off and the vehicle goes into the Accessory Mode. The DIC displays SHIFT TO PARK. Once the shifter is moved to P (Park), the vehicle turns off.

The DIC displays NO FOB, OFF OR RUN?, if the keyless access transmitter is not detected inside the vehicle when it is turned off.

See *DIC Warnings and Messages* on page 3-60 for more information.

## Automatic Transmission Operation

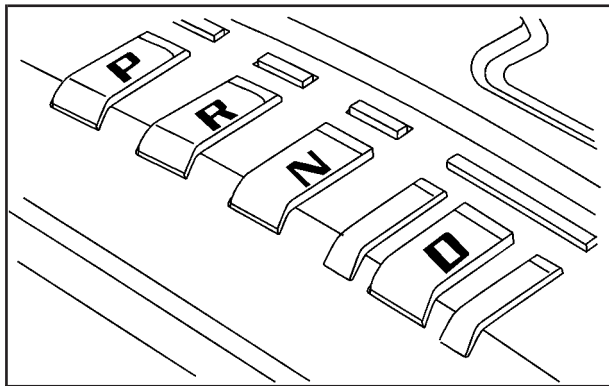

There are several different positions for the shift lever.

**P (Park):** This position locks the rear wheels. It is the best position to use when starting the engine because the vehicle cannot move easily.

### ⚠ CAUTION:

It is dangerous to get out of the vehicle if the shift lever is not fully in P (Park) with the parking brake firmly set. The vehicle can roll.

Do not leave the vehicle when the engine is running unless you have to. If you have left the engine running, the vehicle can move suddenly. You or others could be injured. To be sure the vehicle will not move, even when you are on fairly level ground, always set the parking brake and move the shift lever to P (Park). See *Shifting Into Park* on page 2-33.

Be sure the shift lever is fully in P (Park) before starting the engine.

The vehicle has an automatic transmission shift lock control system. You have to fully apply the regular brakes first and then press the shift lever button before you can shift from P (Park) when the vehicle is running. If you cannot shift out of P (Park), ease pressure on the shift lever and push the shift lever all the way into P (Park) as you maintain brake application. Then press the shift lever button and move the shift lever into another gear. See *Shifting Out of Park* on page 2-35.

**R (Reverse):** Use this gear to back up.

**Notice:** Shifting to R (Reverse) while the vehicle is moving forward could damage the transmission. The repairs would not be covered by the vehicle warranty. Shift to R (Reverse) only after the vehicle is stopped.

To rock the vehicle back and forth to get out of snow, ice, or sand without damaging the transmission, see *If Your Vehicle is Stuck in Sand, Mud, Ice, or Snow* on page 5-20.

**N (Neutral):** In this position, the engine does not connect with the wheels. To restart when you are already moving, use N (Neutral) only. Also, use N (Neutral) when the vehicle is being towed. Use N (Neutral) if the vehicle must be moved with the engine off for short distances. Please see *Towing Your Vehicle* on page 5-26.

 **CAUTION:**

Shifting into a drive gear while the engine is running at high speed is dangerous. Unless your foot is firmly on the brake pedal, the vehicle could move very rapidly. You could lose control and hit people or objects. Do not shift into a drive gear while the engine is running at high speed.

**Notice:** Shifting out of P (Park) or N (Neutral) with the engine running at high speed may damage the transmission. The repairs would not be covered by the vehicle warranty. Be sure the engine is not running at high speed when shifting the vehicle.

**D (Drive):** This position is for normal driving. It provides the best fuel economy for the vehicle. If you need more power for passing and you are:

- Going less than about 35 mph (56 km/h), push the accelerator pedal about halfway down.
- Going about 35 mph (56km/h) or more, push the accelerator all the way down.

Downshifting the transmission in slippery road conditions could result in skidding, see “Skidding” under *Loss of Control* on page 5-12.

**Notice:** Spinning the tires or holding the vehicle in one place on a hill using only the accelerator pedal may damage the transmission. The repair will not be covered by the vehicle warranty. If you are stuck, do not spin the tires. When stopping on a hill, use the brakes to hold the vehicle in place.

Maximum engine speed is limited to protect driveline components from improper operation.

## Driver Shift Control (DSC)

The Driver Shift Control (DSC) feature lets you manually control the operation of the transmission.

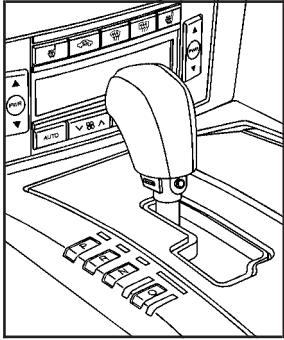

To use this feature, move the shift lever from the D (Drive) position to the left and into the driver shift control gate.

The Sport Automatic Mode is selected by moving the shift lever into the DSC area without shifting towards the + (plus) or – (minus) symbols. While in the Sport Automatic Mode, the transmission computer determines when the vehicle is being driven in a competitive manner.

It then selects and holds the transmission in lower gears giving more noticeable upshifts for sportier vehicle performance. Once you shift to the + (plus) or – (minus) controls, the driver manual gear selection is activated. A + (plus) symbol appears on the shift console above the D (Drive) indicator and minus symbol appears below the indicator. The Head-Up Display (HUD) also displays the requested gear, though the actual upshift or downshift could be delayed until the engine speed is correct for that gear.

The requested gear displays on the HUD until the next time you upshift or downshift. The gear selected and shown in the HUD is one of a number of gears available. The vehicle does not upshift beyond the chosen gear. The actual gear that the vehicle shifts to depends on a combination of the driver-requested gear range, vehicle speed and throttle position.

**Notice:** If you drive the vehicle at high RPMs without upshifting while using Driver Shift Control (DSC), you could damage the vehicle. Always upshift when necessary while using DSC.

If you do not upshift as the engine approaches the red line on the engine RPM (Revolutions Per Minute) gage, the engine speed is controlled to limit the engine RPM.



Not all manual downshift requests will be allowed by the transmission. To prevent excessive engine RPMs, each gear has a maximum vehicle speed associated with it. Any downshift request above this speed is not allowed by the transmission.

If shifting is prevented for any reason, the current gear flashes multiple times in the Driver Information Center (DIC), indicating that the transmission has not shifted gears.

Some automatic downshifts can occur to maintain minimum engine speed. This only happens if the vehicle is left in too high of a gear for the vehicle's speed. For example, if you have been driving in sixth gear range and come to a stop without manually downshifting, the transmission automatically downshifts to first gear and displays first gear on the HUD. As you begin to drive and accelerate, the transmission remains in first gear until the driver selects an upshift.

DSC can be used while using cruise control, but transmission shifting is different while the cruise control is on. This is not a malfunction and is necessary to let proper operation of the cruise control.

To return to fully automatic operation, move the shift lever to the right and back into D (Drive).

When accelerating the vehicle from a stop in snowy and icy conditions, you may want to shift into second gear. A higher gear allows you to gain more traction on slippery surfaces.

In higher gears, on the XLR only, an automatic downshift occurs if you press the accelerator pedal to the floor. This feature provides adequate acceleration capabilities if you forget to downshift manually. Tap the shifter forward and the vehicle upshifts.

## Parking Brake

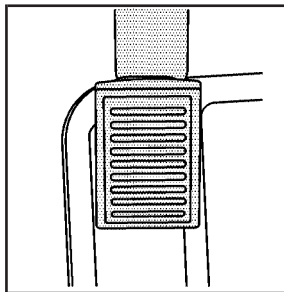

The parking brake pedal is located to the left of the regular brake pedal, near the driver door.

To set the parking brake, hold the regular brake pedal down, then push the parking brake pedal down.

If the ignition is on, the parking brake indicator light on the instrument panel cluster should come on. If it does not, you need to have the vehicle serviced.

When you move out of P (Park) or N (Neutral) and the engine is running, the parking brake should release. If the parking brake has not been fully released and you try to drive off with the parking brake on, the parking brake indicator light will come on and stay on.

If the parking brake does not fully release, you can manually release the pedal.

### CAUTION:

Always shift to P (Park) before pulling the manual release lever. If your hand or arm is in the way of the pedal you could be hurt. The pedal springs back quickly. Keep your hand and arm away when you use the manual release lever.

Before releasing the manual parking brake, be sure to put the vehicle in P (Park) and turn the ignition off.

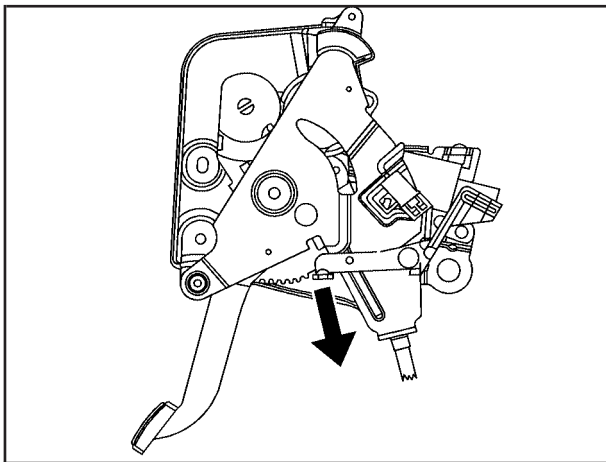

Reach under the driver side of the instrument panel and pull down on the manual release lever, which is located behind the parking brake pedal. Pull down on the yellow tab. If the parking brake does not release, you should have the vehicle towed to your dealer/retailer for service.

**Notice:** Driving with the parking brake on can overheat the brake system and cause premature wear or damage to brake system parts. Make sure that the parking brake is fully released and the brake warning light is off before driving.

## Shifting Into Park

### ⚠ CAUTION:

It can be dangerous to get out of the vehicle if the shift lever is not fully in P (Park) with the parking brake firmly set. The vehicle can roll. If you have left the engine running, the vehicle can move suddenly. You or others could be injured. To be sure the vehicle will not move, even when you are on fairly level ground, use the steps that follow.

1. Hold the brake pedal down and set the parking brake.  
See *Parking Brake* on page 2-32 for more information.
2. Move the shift lever into P (Park) by pushing the lever all the way toward the front of the vehicle.
3. Turn the ignition off.

## Leaving the Vehicle With the Engine Running

### CAUTION:

It can be dangerous to leave the vehicle with the engine running. The vehicle could move suddenly if the shift lever is not fully in P (Park) with the parking brake firmly set. And, if you leave the vehicle with the engine running, it could overheat and even catch fire. You or others could be injured. Do not leave the vehicle with the engine running.

If you have to leave the vehicle with the engine running, be sure the vehicle is in P (Park) and the parking brake is firmly set before you leave it. After you have moved the shift lever into P (Park), hold down the regular brake pedal. See if you can move the shift lever away from P (Park) without first pulling it toward you. If you can, it means that the shift lever was not fully locked into P (Park).

## Torque Lock

If you are parking on a hill and you do not shift the transmission into P (Park) properly, the weight of the vehicle may put too much force on the parking pawl in the transmission. You may find it difficult to pull the shift lever out of P (Park). This is called “torque lock.” To prevent torque lock, set the parking brake and then shift into P (Park) properly before you leave the driver seat. To find out how, see “Shifting Into Park” listed previously in this section.

When you are ready to drive, move the shift lever out of P (Park) before you release the parking brake.

If torque lock does occur, you may need to have another vehicle push yours a little uphill to take some of the pressure from the parking pawl in the transmission, so you can pull the shift lever out of P (Park).

## Shifting Out of Park

Shift lock release prevents shifting out of P (Park) unless the vehicle is running or in Accessory mode and the brake pedal is applied.

The shift lock release is always functional except in the case of an uncharged or low voltage (less than 9-volt) battery. See *Jump Starting on page 6-36* for more information.

To shift out of P (Park) use the following:

1. Apply the brake pedal.
2. Press the shift lever button.
3. Move the shift lever to the desired position.

If you still are unable to shift out of P (Park):

1. Fully release the shift lever button.
2. While holding down the brake pedal, press the shift lever button again.
3. Move the shift lever to the desired position.

If you still cannot move the shift lever from P (Park), consult your dealer/retailer or a professional towing service.

## Parking Over Things That Burn

### CAUTION:

Things that can burn could touch hot exhaust parts under the vehicle and ignite. Do not park over papers, leaves, dry grass, or other things that can burn.

## Engine Exhaust

### CAUTION:

Engine exhaust contains Carbon Monoxide (CO) which cannot be seen or smelled. Exposure to CO can cause unconsciousness and even death.

Exhaust may enter the vehicle if:

- The vehicle idles in areas with poor ventilation (parking garages, tunnels, deep snow that may block underbody airflow or tail pipes).
- The exhaust smells or sounds strange or different.
- The exhaust system leaks due to corrosion or damage.

CAUTION: (Continued)

### CAUTION: (Continued)

- The vehicle's exhaust system has been modified, damaged or improperly repaired.
- There are holes or openings in the vehicle body from damage or after-market modifications that are not completely sealed.

If unusual fumes are detected or if it is suspected that exhaust is coming into the vehicle:

- Drive it only with the windows completely down.
- Have the vehicle repaired immediately.

Never park the vehicle with the engine running in an enclosed area such as a garage or a building that has no fresh air ventilation.

## Running the Vehicle While Parked

It is better not to park with the engine running. But if you ever have to, here are some things to know.

### CAUTION:

Idling a vehicle in an enclosed area with poor ventilation is dangerous. Engine exhaust may enter the vehicle. Engine exhaust contains Carbon Monoxide (CO) which cannot be seen or smelled. It can cause unconsciousness and even death. Never run the engine in an enclosed area that has no fresh air ventilation. For more information, see Engine Exhaust *Engine Exhaust on page 2-36*.

### CAUTION:

It can be dangerous to get out of the vehicle if the automatic transmission shift lever is not fully in P (Park) with the parking brake firmly set. The vehicle can roll. Do not leave the vehicle when the engine is running unless you have to. If you have left the engine running, the vehicle can move suddenly. You or others could be injured. To be sure the vehicle will not move, even when you are on fairly level ground, always set the parking brake and move the shift lever to P (Park).

Follow the proper steps to be sure the vehicle will not move. See *Shifting Into Park on page 2-33*.

## Mirrors

### Automatic Dimming Rearview Mirror

This vehicle has an automatic dimming inside rearview mirror with OnStar® controls. See *OnStar® System on page 2-42* for more information.

 **(On/Off):** Press to turn the dimming feature on or off.

### Automatic Dimming Mirror Operation

Automatic dimming reduces the glare of lights from behind the vehicle. The dimming feature comes on and the indicator light illuminates each time the vehicle is started.



### Cleaning the Mirror

Do not spray glass cleaner directly on the mirror. Use a soft towel dampened with water.

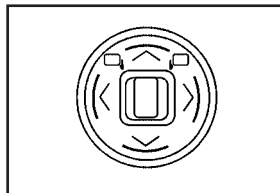
## Outside Power Mirrors



Controls for the outside power mirrors are located on the driver's door armrest.

1. Move  or  (selector switches) to the left or right to choose the driver's or passenger side mirror.
2. Press one of the four edges located on the control pad to move the mirror to the desired direction.
3. Adjust each outside mirror so that a little of the vehicle and the area behind can be seen.

Keep the selector switch in the center position when not adjusting either outside mirror.

Manually fold the mirrors inward by pulling them toward the vehicle. This feature may be useful when going through a car wash or a confined space. Push the mirrors away from the vehicle, to the normal position, before driving.



## Outside Automatic Dimming Mirror

The driver's side mirror adjusts for the glare of headlamps behind you. This feature is controlled by the on and off settings on the inside automatic dimming rearview mirror. See *Automatic Dimming Rearview Mirror on page 2-38* for more information.

## Park Assist Mirror

Vehicles with the memory package are capable of having the passenger mirror tilt to a preselected position when the vehicle is in R (Reverse). This feature lets the driver view the curb when parallel parking. If further adjustment is needed after the mirror is tilted, the mirror switch may be used. The mirror then returns to this new position when the vehicle is shifted into R (Reverse).

When the vehicle is shifted out of R (Reverse) and a five-second delay has occurred, the passenger side mirror returns to its original position.

Turn this feature on or off through the Driver Information Center (DIC). See *DIC Vehicle Personalization on page 3-72* for more information.

## Outside Convex Mirror

### CAUTION:

A convex mirror can make things (like other vehicles) look farther away than they really are. If you cut too sharply into the right lane, you could hit a vehicle on the right. Check the inside mirror or glance over your shoulder before changing lanes.

The passenger side mirror is convex shaped. A convex mirror's surface is curved so more can be seen from the driver's seat.

## Outside Heated Mirrors

 **(Rear Window Defogger):** Press to heat the mirrors. See "Rear Window Defogger" under *Dual Climate Control System on page 3-36*.

Store the preferred mirror position by using the memory option. See *Memory Seat, Mirrors and Steering Wheel on page 1-3*.

# Object Detection Systems

## Ultrasonic Rear Parking Assist (URPA)

For vehicles with the URPA system, it operates at speeds less than 3 mph (5 km/h), and assists the driver with parking and avoiding objects while in R (Reverse). The sensors on the rear bumper are used to detect the distance to an object up to 5 feet (1.5 m) behind the vehicle, and at least 10 inches (25.4 cm) off the ground.

### CAUTION:

The Ultrasonic Rear Parking Assist (URPA) system does not replace driver vision. It cannot detect:

- objects that are below the bumper, underneath the vehicle, or if they are too close or far from the vehicle
- children, pedestrians, bicyclists, or pets.

CAUTION: (Continued)

### CAUTION: (Continued)

If you do not use proper care before and while backing; vehicle damage, injury, or death could occur. Even with URPA, always check behind the vehicle before backing up. While backing, be sure to look for objects and check the vehicle's mirrors.

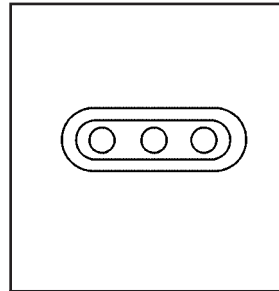

The display is located between the driver and passenger seatbacks.

URPA uses three color-coded lights to provide distance and system information.

## How the System Works

URPA comes on automatically when the shift lever is moved into R (Reverse). The rear display briefly illuminates to indicate the system is working.

URPA operates only at speeds less than 3 mph (5 km/h). If the vehicle is above this speed, the red light on the rear display will flash.

To be detected, objects must be at least 10 inches (25.4 cm) off the ground and below trunk level. Objects must also be within 5 feet (1.5 m) from the rear bumper. This distance may be less during warmer or humid weather.

A single beep will sound the first time an object is detected between 20 inches (0.5 m) and 5 feet (1.5 m) away. Beeping will occur when the vehicle is closer than 20 inches (0.5 m) from the object.

The following describes what will occur with the URPA display as the vehicle gets closer to a detected object:

Description	English	Metric
amber light	5 ft	1.5 m
amber/amber lights	40 in	1.0 m
amber/amber/red lights/continuous beep	20 in	0.5 m
amber/amber/red lights flashing and continuous beep	1 ft	0.3 m

## When the System Does Not Seem to Work Properly

If the URPA system will not activate due to a temporary condition, a red light will be shown on the rear URPA display when the shift lever is moved into R (Reverse). This occurs under the following conditions:

- The ultrasonic sensors are not clean. Keep the vehicle's rear bumper free of mud, dirt, snow, ice and slush. For cleaning instructions, see *Washing Your Vehicle on page 6-77*.
- An object was hanging out of the trunk during the last drive cycle. Once the object is removed, URPA will return to normal operation.
- The vehicle's bumper is damaged. Take the vehicle to your dealer/retailer to repair the system.
- Other conditions may affect system performance, such as vibrations from a jackhammer or the compression of air brakes on a very large truck.

If the system is still disabled after driving forward at least 15 mph (25 km/h), take the vehicle to your dealer/retailer.

## OnStar<sup>®</sup> System

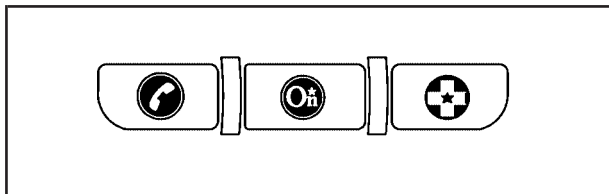

OnStar uses several innovative technologies and live advisors to provide a wide range of safety, security, information, and convenience services. If the airbags deploy, the system is designed to make an automatic call to OnStar Emergency advisors who can request emergency services be sent to your location. If the keys are locked in the vehicle, call OnStar at 1-888-4-ONSTAR to have a signal sent to unlock the doors. OnStar Hands-Free Calling, including 30 trial minutes good for 60 days, is available on most vehicles. OnStar Turn-by-Turn Navigation service, with one trial route, is available on most vehicles. Press the OnStar button to have an OnStar advisor contact Roadside Service.

OnStar service is provided subject to the OnStar Terms and Conditions included in the OnStar Subscriber glove box literature.

Some services such as Remote Door Unlock or Stolen Vehicle Location Assistance may not be available until the owner of the vehicle registers with OnStar. After the first prepaid year, contact OnStar to select a monthly or annual subscription payment plan. If a payment plan is not selected, the OnStar system and all services, including airbag notification and emergency services, may be deactivated and no longer available. For more information visit [onstar.com](http://onstar.com) (U.S.) or [onstar.ca](http://onstar.ca) (Canada), or press the OnStar button to speak with an advisor.

Not all OnStar services are available on all vehicles. To check if this vehicle is able to provide the services described below, or for a full description of OnStar services and system limitations, see the OnStar Owner's Guide in the glove box or visit [onstar.com](http://onstar.com) (U.S.) or [onstar.ca](http://onstar.ca) (Canada), contact OnStar at 1-888-4-ONSTAR (1-888-466-7827) or TTY 1-877-248-2080, or press the OnStar button to speak with an OnStar advisor 24 hours a day, 7 days a week.

## **OnStar Services Available with the Safe & Sound Plan**

- Automatic Notification of Airbag Deployment
- Advanced Automatic Crash Notification (AACN) (If equipped)
- Link to Emergency Services
- Roadside Assistance
- Stolen Vehicle Location Assistance
- Remote Door Unlock/Vehicle Alert
- OnStar Vehicle Diagnostic Email
- GM Goodwrench On Demand Diagnostics
- OnStar Hands-Free Calling with 30 trial minutes
- OnStar Virtual Advisor (U.S. Only)

## **OnStar Services Included with Directions & Connections Plan**

- All Safe and Sound Plan Services
- OnStar Turn-by-Turn Navigation (If equipped) or Driving Directions - Advisor delivered
- RideAssist
- Information and Convenience Services

## **OnStar Hands-Free Calling**

OnStar Hands-Free Calling allows eligible OnStar subscribers to make and receive calls using voice commands. Hands-Free Calling is fully integrated into the vehicle, and can be used with OnStar Pre-Paid Minute Packages. Most vehicles include 30 trial minutes good for 60 days. Hands-Free Calling can also be linked to a Verizon Wireless service plan in the U.S. or a Bell Mobility service plan in Canada, depending on eligibility. To find out more, refer to the OnStar Owner's Guide in the vehicle's glove box, visit [onstar.com](http://onstar.com) or [onstar.ca](http://onstar.ca), or speak with an OnStar advisor by pressing the OnStar button or calling 1-888-4-ONSTAR (1-888-466-7827).

## **OnStar Turn-by-Turn Navigation**

Vehicles with the OnStar Turn-by-Turn Navigation system can provide voice-guided driving directions. Press the OnStar button to have an OnStar advisor locate a business or address and download driving directions to the vehicle. Voice-guided directions to the desired destination will play through the audio system speakers. See the OnStar Owner's Guide for more information.

## OnStar Virtual Advisor

OnStar Virtual Advisor is a feature of OnStar Hands-Free Calling that uses minutes to access location-based weather, local traffic reports, and stock quotes. Press the phone button and give a few simple voice commands to browse through the various topics. See the OnStar Owner's Guide for more information. This feature is only available in the continental U.S.

## OnStar Steering Wheel Controls

This vehicle may have a Talk/Mute button that can be used to interact with OnStar Hands-Free Calling. See *Audio Steering Wheel Controls on page 3-88* for more information.

On some vehicles, the mute button can be used to dial numbers into voice mail systems, or to dial phone extensions. See the OnStar Owner's Guide for more information.

## How OnStar Service Works

The OnStar system can record and transmit vehicle information. This information is automatically sent to an OnStar Call Center when the OnStar button is pressed, the emergency button is pressed, or if the airbags or AACN system deploy. This information usually includes the vehicle's GPS location and, in the event of a crash, additional information regarding the crash that the vehicle was involved in (e.g. the direction from which the vehicle was hit). When the Virtual Advisor feature of OnStar Hands-Free Calling is used, the vehicle also sends OnStar the vehicle's GPS location so they can provide services where it is located.

OnStar service cannot work unless the vehicle is in a place where OnStar has an agreement with a wireless service provider for service in that area. OnStar service also cannot work unless the vehicle is in a place where the wireless service provider OnStar has hired for that area has coverage, network capacity and reception when the service is needed, and technology that is compatible with the OnStar service. Not all services are available everywhere, particularly in remote or enclosed areas, or at all times.

Location information about the vehicle is only available if the GPS satellite signals are unobstructed and available.

The vehicle must have a working electrical system, including adequate battery power, for the OnStar equipment to operate. There are other problems OnStar cannot control that may prevent OnStar from providing OnStar service at any particular time or place. Some examples are damage to important parts of the vehicle in a crash, hills, tall buildings, tunnels, weather or wireless phone network congestion.

## Your Responsibility

Increase the volume of the radio if the OnStar advisor cannot be heard. If the light next to the OnStar buttons is red, the system may not be functioning properly. Press the OnStar button and request a vehicle diagnostic. If the light appears clear (no light is appearing), your OnStar subscription has expired and all services have been deactivated. Press the OnStar button to confirm that the OnStar equipment is active.

## Universal Home Remote System

The Universal Home Remote System provides a way to replace up to three hand-held radio-frequency (RF) transmitters used to activate devices such as garage door openers, security systems, and home lighting.

This device complies with Part 15 of the FCC Rules. Operation is subject to the following two conditions:

1. This device may not cause harmful interference.
2. This device must accept any interference received, including interference that may cause undesired operation.

The FCC Grant of Equipment Authorization Certificate number is KOBGTV06A.

This device complies with RSS-210 of Industry Canada. Operation is subject to the following two conditions:

1. This device may not cause interference.
2. This device must accept any interference received, including interference that may cause undesired operation of the device.

The Canadian Registration ID number is 3521A-GTV06A.

Changes or modifications to this system by other than an authorized service facility could void authorization to use this equipment.

## Universal Home Remote System Operation

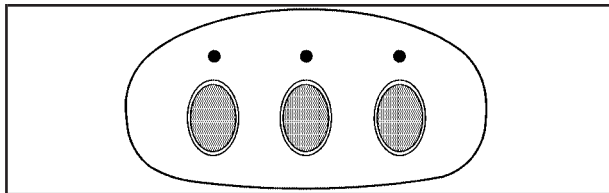

On vehicles with this feature there are three round Light Emitting Diode (LED) indicator lights above the Universal Home Remote buttons, follow the instructions below.

This system provides a way to replace up to three remote control transmitters used to activate devices such as garage door openers, security systems, and home automation devices.

Do not use this system with any garage door opener that does not have the stop and reverse feature. This includes any garage door opener model manufactured before April 1, 1982.

Read the instructions completely before attempting to program the transmitter. Because of the steps involved, it may be helpful to have another person assist with programming the transmitter.

Be sure to keep the original remote control transmitter for use in other vehicles, as well as, for future programming. Only the original remote control transmitter is needed for Fixed Code programming. The programmed buttons should be erased when the vehicle is sold or the lease ends. See “Erasing Universal Home Remote Buttons” later in this section.

Park the vehicle outside of the garage when programming a garage door. Be sure that people and objects are clear of the garage door or gate that is being programmed.

## Programming Universal Home Remote — Rolling Code

For questions or help programming the Universal Home Remote System, call 1-866-572-2728 or go to [learcar2u.com](http://learcar2u.com).

Most garage door openers sold after 1996 are Rolling Code units.

Programming a garage door opener involves time-sensitive actions, so read the entire procedure before starting. Otherwise, the device will time out and the procedure will have to be repeated.



To program up to three devices:

1. Press START or put the vehicle in accessory mode. See *Ignition Positions on page 2-24* for additional information.

Programming can only occur when the vehicle is running or in accessory mode.

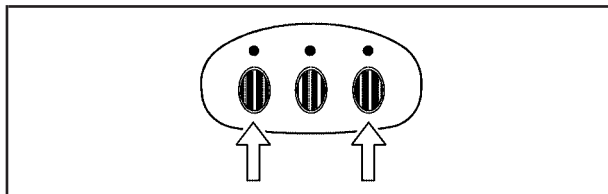

2. From inside the vehicle, press the two outside buttons at the same time for one to two seconds, and immediately release them.

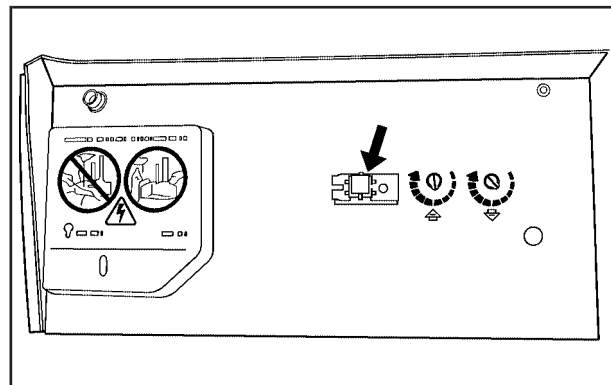

3. Locate in the garage, the garage door opener receiver (motor-head unit). Locate the “Learn” or “Smart” button. It can usually be found where the hanging antenna wire is attached to the motor-head unit and may be a colored button. Press this button. After pressing this button, complete the following steps in less than 30 seconds.

4. Immediately return to the vehicle. Press and hold the Universal Home Remote button that will be used to control the garage door until the garage door moves. The indicator light, above the selected button, should slowly blink. This button may need to be held for up to 20 seconds.
5. Immediately, within one second, release the button when the garage door moves. The indicator light blinks rapidly until programming is complete.
6. Press and release the same button again. The garage door should move, confirming that programming is successful and complete.

To program another Rolling Code device such as an additional garage door opener, a security device, or home automation device, repeat Steps 1-6, choosing a different function button in Step 4 than what was used for the garage door opener.

If these instructions do not work, the garage door opener is probably a Fixed Code unit. Follow the Programming instructions that follow for a Fixed Code garage door opener.

## Programming Universal Home Remote — Fixed Code

For questions or help programming the Universal Home Remote System, call 1-866-572-2728 or go to [learcar2u.com](http://learcar2u.com).

Most garage door openers sold before 1996 are Fixed Code units.

Programming a garage door opener involves time-sensitive actions, so read the entire procedure before starting. Otherwise, the device will time out and the procedure will have to be repeated.

To program up to three devices:

1. Press START or put the vehicle in accessory mode. See *Ignition Positions on page 2-24* for additional information.

Programming can only occur when the vehicle is running or in accessory mode.

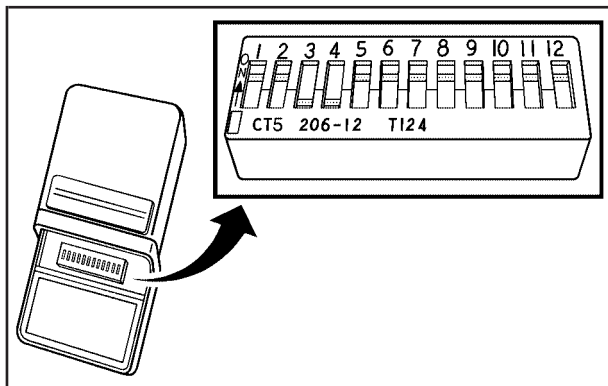

- To verify that the garage door opener is a Fixed Code unit, remove the battery cover on the hand held transmitter supplied by the manufacturer of the garage door opener motor. If there are a row of dip switches similar to the graphic above, the garage door opener is a Fixed Code unit. If you do not see a row of dip switches, return to the previous section for Programming Universal Home Remote – Rolling Code.

The hand held transmitter can have between eight to 12 dip switches depending on the brand of transmitter.

The garage door opener receiver (motor head unit) could also have a row of dip switches that can be used when programming the Universal Home Remote. If the total number of switches on the motor head and hand held transmitter are different, or if the dip switch settings are different, use the dip switch settings on the motor head unit to program the Universal Home Remote. The motor head dip switch settings can also be used when the original hand held transmitter is not available.

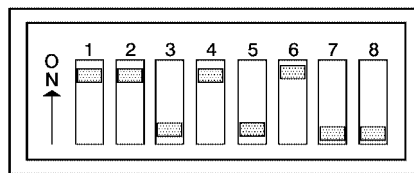

Switch Number	1	2	3	4	5	6	7	8
Switch Position	On	On	Off	On	Off	On	Off	Off
Your Universal Home Remote Button	Left	Left	Right	Left	Right	Left	Right	Right

**Example of Eight Dip Switches with Two Positions**

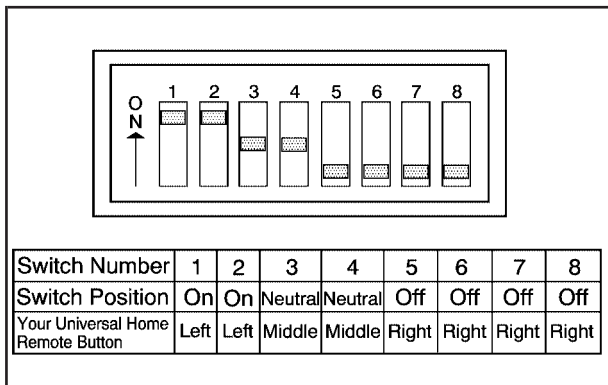

### Example of Eight Dip Switches with Three Positions

The panel of switches might not appear exactly as they do in the examples above, but they should be similar.

The switch positions on the hand-held transmitter could be labeled, as follows:

- A switch in the up position could be labeled as “Up,” “+,” or “On.”
- A switch in the down position could be labeled as “Down,” “-,” or “Off.”
- A switch in the middle position could be labeled as “Middle,” “0,” or “Neutral.”

3. Write down the eight to 12 switch settings from left to right as follows:

- When a switch is in the up position, write “Left.”
- When a switch is in the down position, write “Right.”
- If a switch is set between the up and down position, write “Middle.”

The switch settings written down in Step 3 now become the button strokes to be entered into the Universal Home Remote in Step 5.

Be sure to enter the switch settings written down in Step 3, in order from left to right, into the Universal Home Remote, when completing Step 5.

4. From inside the vehicle, first firmly press all three buttons at the same time for about three seconds. Release the buttons to put the Universal Home Remote into programming mode.

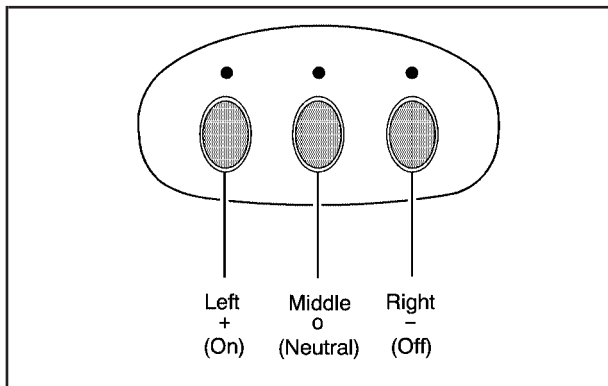

5. The indicator lights blink slowly. Enter each switch setting from Step 3 into the vehicle's Universal Home Remote. You have two and one-half minutes to complete Step 5. Now press one button on the Universal Home Remote for each switch setting as follows:

- If you wrote "Left," press the left button in the vehicle.
- If you wrote "Right," press the right button in the vehicle.
- If you wrote "Middle," press the middle button in the vehicle.

6. After entering all of the switch positions, again, firmly press and release all three buttons at the same time. The indicator lights turn on.
7. Press and hold the button that will be used to control the garage door until the garage door moves. The indicator light above the selected button should slowly blink. This button may need to be held for up to 55 seconds.
8. Immediately release the button when the garage door moves. The indicator light blinks rapidly until programming is complete.
9. Press and release the same button again. The garage door should move, confirming that programming is successful and complete.

To program another Fixed Code device such as an additional garage door opener, a security device, or home automation device, repeat Steps 1-9, choosing a different button in Step 7 than what was used for the garage door opener.

## Using Universal Home Remote

Press and hold the appropriate button for at least half of a second. The indicator light comes on while the signal is being transmitted.

Operation can occur:

- If the vehicle is in accessory mode.
- If the vehicle is in running.
- If the vehicle is in Retained Accessory Mode (RAP). See *Retained Accessory Power (RAP)* on page 2-25 for more information.
- Up to an additional 10 minutes after RAP finishes.
- Up to 10 minutes after any door is opened.

## Reprogramming Universal Home Remote Buttons

Any of the three buttons can be reprogrammed by repeating the instructions.

## Erasing Universal Home Remote Buttons

The programmed buttons should be erased when the vehicle is sold or the lease ends.

To erase either Rolling Code or Fixed Code on the Universal Home Remote device:

1. Press and hold the two outside buttons at the same time for approximately 20 seconds, until the indicator lights, located directly above the buttons, begin to blink rapidly.
2. Once the indicator lights begin to blink, release both buttons. The codes from all buttons are erased.

For help or information on the Universal Home Remote System, call the customer assistance phone number under *Customer Assistance Offices* on page 8-6.

## **Storage Areas**

### **Glove Box**

Lift the glovebox handle up to open it. Use the key to lock and unlock the glovebox.

### **Cupholders**

The cupholders are located under a lid in the front console to the right of the shift lever. Press the left side of the lid and it will open automatically.

### **Center Console Storage**

There is a center console storage area located between the seats. To open this storage area, push the latch button and lift the lid.

There is also an upright center console storage area between the seatbacks. To open the storage area, press and release the button near the top so it extends out. Then, turn the button in either direction to unlatch the lid and pull the console lid down. After closing the lid, press the release button back in.

### **Floor Mats**

The driver side floor mat is held in place by two snaps and the passenger side is held in place by one. To remove the floor mats, pull up on the rear of the mat to disconnect from the snaps. To reinstall, line up the openings in the floor mat over the snaps and push down into place.

Be sure that the driver side floor mat is properly placed on the floor so that it does not block the movement of the accelerator pedal.

## Rear Storage Area

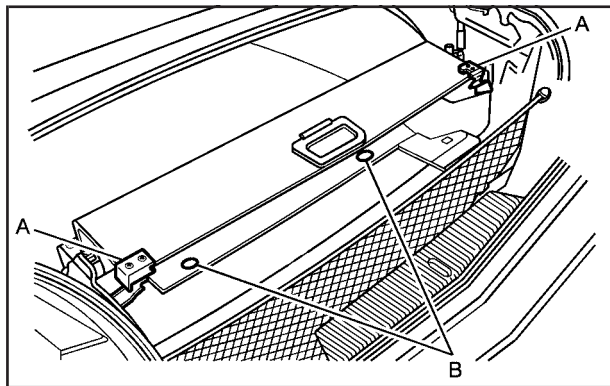

There is a cargo divider located in the trunk to keep cargo from getting in the way of the retractable hardtop. The cargo divider must be in place for the top to move.

To install the cargo divider, snap the bottom of the divider onto the snaps (B) located on the floor of the trunk. Then, pull the divider up and place the pins on each side of the divider into the notches (A) on either side of the trunk.

There is also a storage compartment located in the trunk on the passenger side.

To access the storage compartment, unsnap the lid. To reinstall the lid, line up the opening in the lid over the snap and push down into place.

## Convenience Net

Use the convenience net, located in the rear, to store small loads as far forward as possible. The net should not be used to store heavy loads.

## Retractable Hardtop

The following procedures explain the proper operation of the retractable hardtop. The retractable hardtop will not operate if the valet lockout switch is on.

If the retractable hardtop is lowered or raised multiple times, the engine should be running while doing so to prevent drain on the vehicle's battery.

### CAUTION:

When the retractable hardtop is opened or closed, people can be injured by the parts that move: the hardtop and its mechanism, the trunk lid, and the side windows. Keep people away from these parts when you are lowering or raising the top.



## Lowering the Retractable Hardtop

**Notice:** Leaving the retractable hardtop down and exposing the interior of the vehicle to outdoor conditions may cause damage. Always close the retractable hardtop if leaving the vehicle outdoors.

1. Park on a level surface and shift the transmission into P (Park).
2. The vehicle's engine must be on or in Acc.
3. Lower both sun visors.

**Notice:** Raising or lowering the top while the vehicle is in motion can cause damage to the top or top mechanism. Make sure the vehicle is in P (Park) to lower or raise the top.

**Notice:** Lowering the top if it is damp, wet, or dirty can cause stains, mildew, and damage to the inside of your vehicle. Dry off the top before lowering it.

4. Make sure that nothing or no one is on or around the top. Make sure the trunk cargo cover is in place with nothing on top or in front of the cargo cover. See *Rear Storage Area on page 2-54* for more information. Also, make sure the valet lockout switch is off.

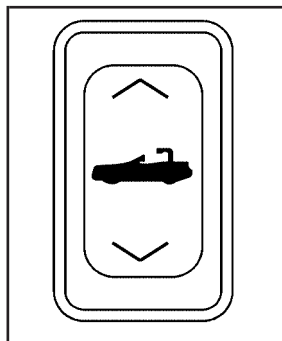

5. Push and hold the bottom of this button located on the console behind the shifter lever.

The windows will automatically lower and the top will automatically lower into the storage area. A chime will sound when the top has lowered completely.

If the radio is on, the sound may be muted briefly while the retractable top is lowered. This occurs because a new audio system equalization is being loaded.

Under certain conditions, the Driver Information Center (DIC) may display messages regarding the retractable hardtop. See *DIC Warnings and Messages on page 3-60* for more information.

If the retractable hardtop does not operate, and there are no messages displayed on the Driver Information Center (DIC), then perform the "Power Window Initialize" steps under *Power Windows on page 2-18*.

## Raising the Retractable Hardtop

1. Park on a level surface. Shift the transmission into P (Park).
2. The vehicle's engine must be on or in Acc.
3. Lower both sun visors.

**Notice:** Raising or lowering the top while the vehicle is in motion can cause damage to the top or top mechanism. Make sure the vehicle is in P (Park) to lower or raise the top.

4. Make sure nothing or no one is on or around the top. Make sure the trunk cargo cover is in place with no cargo on top of or in front of the cargo cover. See *Rear Storage Area on page 2-54* for more information. Also, be sure the valet lockout switch is off.

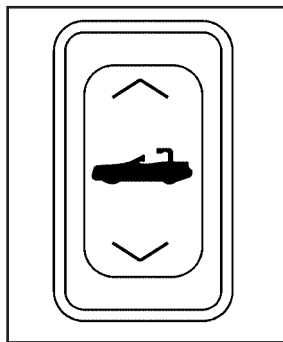

5. Push and hold the top of this button located behind the shift lever.

The windows will automatically lower and the top will raise. A chime will sound when the top has raised completely.

After the top is fully raised, release the retractable hardtop button.

If the radio is on, you may notice a brief mute in sound. This is normal and due to a new audio system equalization being loaded for the vehicle with the top raised.

Under certain conditions, the Driver Information Center (DIC) may display messages regarding the retractable hardtop. See *DIC Warnings and Messages on page 3-60* for more information.

If the retractable hardtop does not operate, and there are no messages displayed on the Driver Information Center (DIC), then perform the “Power Window Initialize” steps under *Power Windows* on page 2-18.

## Manually Raising the Retractable Hardtop

If the vehicle has a power loss, such as a dead battery, you can still raise the top manually by doing the following:

1. Lower both sun visors and open both doors.
2. Use the key to open the trunk. See *Keys* on page 2-3 and *Trunk* on page 2-14 for more information.
3. Raise the trunk by hand.

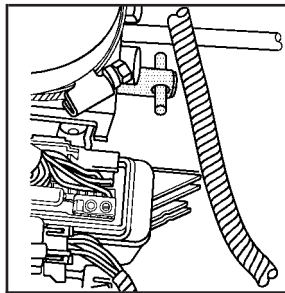

4. Find the hydraulic pump under the carpet on the rear driver side of the trunk. Open the valve by turning it counterclockwise with your hand until it stops.

**Notice:** Pressing the retractable hardtop button when the hydraulic pump valve is open can damage the pump. Always close the hydraulic pump valve after the retractable hardtop has been closed manually.

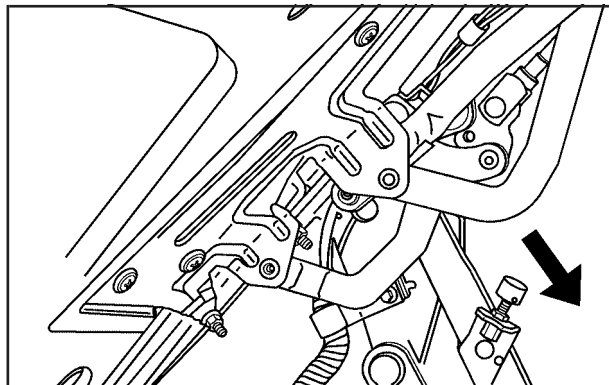

5. Pull both sides of the rear tonneau over-center link down to unlock the linkage.

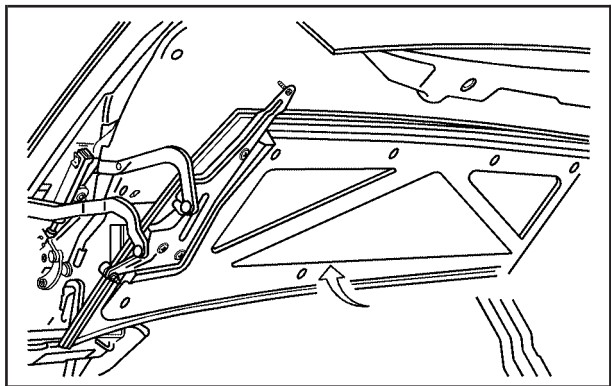

6. Move the rear tonneau rearward and up to the stored position. Pull from the center of the tonneau to keep pressure even. The rubber bumper on each corner will fit against the underside of the trunk decklid.

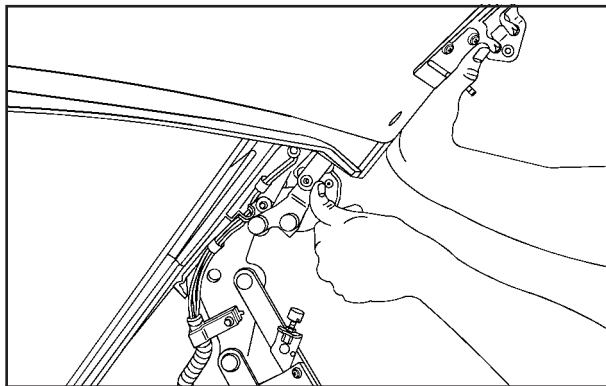

7. Push both sides of the rear tonneau over-center link up until they stop to lock the linkage.  
8. Close the hydraulic pump valve by turning it clockwise with your hand until it stops.

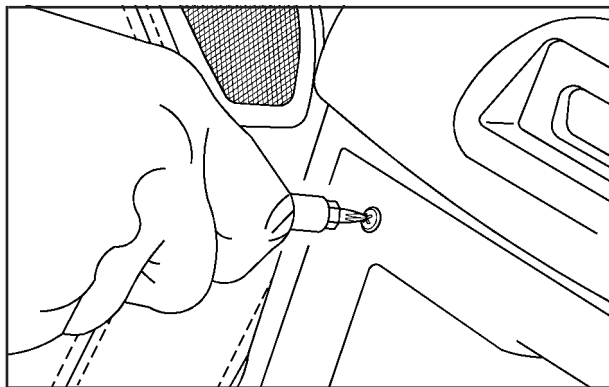

9. Remove the upright center storage compartment. Use the wrench to remove the four screws holding the storage area in place.

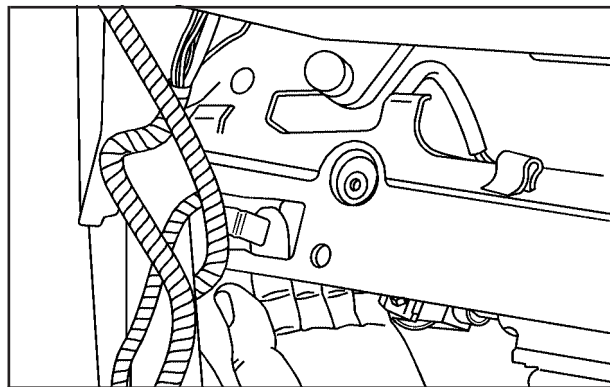

10. Reach behind the square hole and push the front tonneau over-center link up. The front tonneau should pull up easily. If it does not, push the over-center link up more.

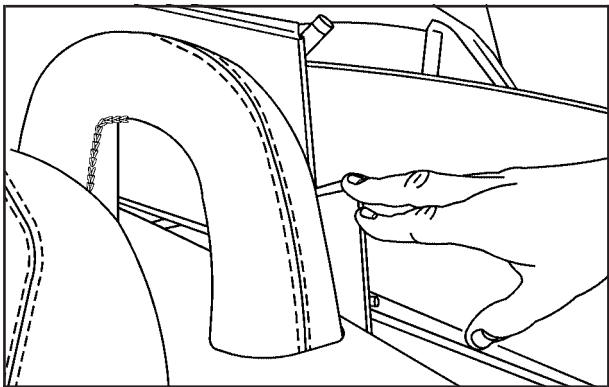

11. Manually move the front tonneau to the open position. Once the front tonneau is open, fold the side wings by gently pressing them in. Do not force the wings. If they are hard to move, make sure the front tonneau is open all the way.

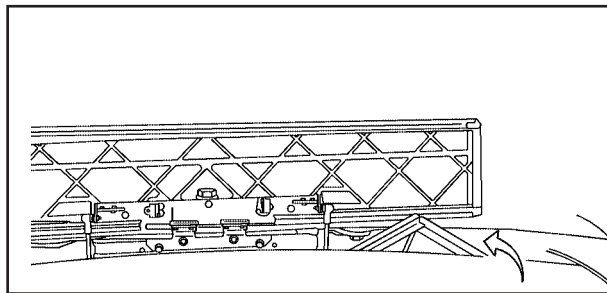

12. Reach in from the side of the vehicle and under the top to remove the headliner plug. The plug will be located in the center of the top near the front.
13. Insert the wrench into the bolt beneath the plug location. Turn the wrench about one-quarter turn counterclockwise until it stops while gently pulling up on the center of the top to release it.

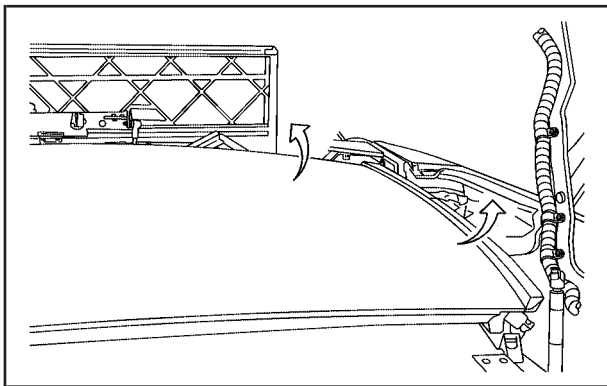

14. Hold the top in the front and side and lift the top out of the stored position.

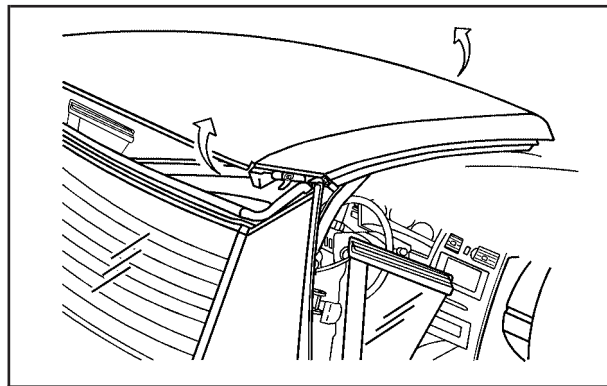

15. Hold the top in the front and the rear and lift the top until it is almost closed. Be careful not to pinch your fingers between the rear of the top and the rear window.

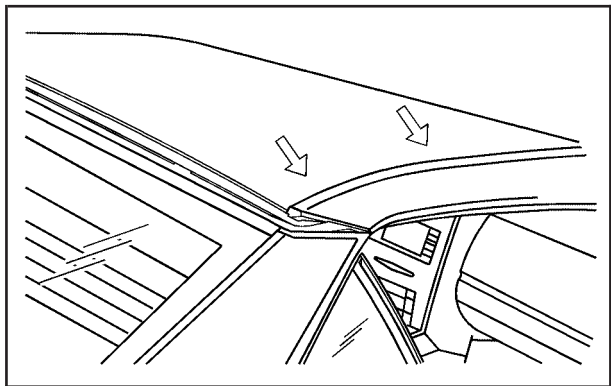

16. Place your hands on the top and guide the top into the closed position.

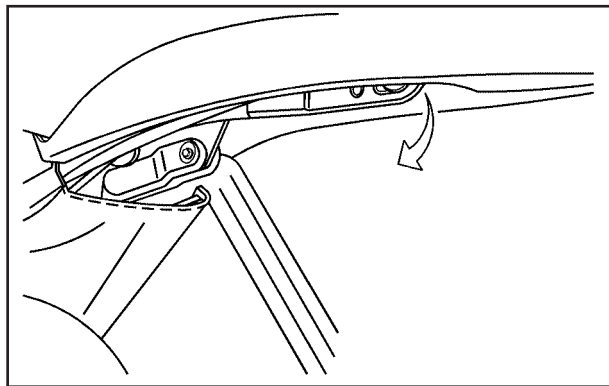

17. While sitting in the driver seat, pull down on the rear of the top.



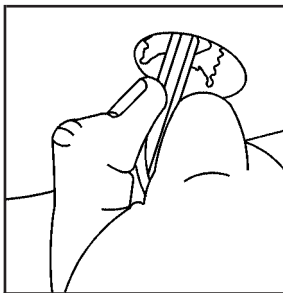

18. While holding the rear of the top down, insert the wrench into the bolt in the plug opening in the headliner.

Turn the wrench counterclockwise until it stops to fully open the latch jaws around the pins.

19. Pull down on the roof with the latch turned open. Turn the wrench clockwise until it stops to lock the top into position. Push up on the roof. If it moves away from the windshield header it is not latched and you will need to repeat the previous steps.

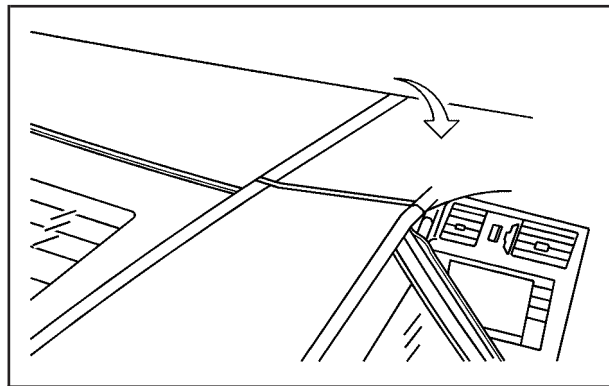

20. From outside the vehicle, push down on both rear corners of the top to make sure it is completely locked into place.
21. From inside the vehicle, reach behind the headrest and gently pull the wings out a small amount. Then, fold the front tonneau to the closed position.
22. Manually close the trunk.



## Section 3 Instrument Panel

---

<b>Instrument Panel Overview</b> .....	3-4	Headlamps on Reminder .....	3-27
Hazard Warning Flashers .....	3-6	Daytime Running Lamps (DRL) .....	3-27
Horn .....	3-6	Adaptive Forward Lighting System .....	3-28
Power Tilt Wheel and Telescopic Steering Column .....	3-6	Fog Lamps .....	3-28
Heated Steering Wheel .....	3-7	Twilight Sentinel® .....	3-29
Turn Signal/Multifunction Lever .....	3-7	Exterior Lighting Battery Saver .....	3-30
Turn and Lane-Change Signals .....	3-7	Instrument Panel Brightness .....	3-30
Headlamp High/Low-Beam Changer .....	3-8	Courtesy Lamps .....	3-30
Flash-to-Pass .....	3-8	Entry/Exit Lighting .....	3-30
Windshield Wipers .....	3-8	Reading Lamps .....	3-30
Rainsense™ Wipers .....	3-9	Battery Run-Down Protection .....	3-31
Windshield Washer .....	3-10	Head-Up Display (HUD) .....	3-31
Headlamp Washer .....	3-11	Accessory Power Outlet(s) .....	3-34
Cruise Control .....	3-11	Ashtray(s) and Cigarette Lighter .....	3-35
Adaptive Cruise Control .....	3-14	<b>Climate Controls</b> .....	3-36
Exterior Lamps .....	3-26	Dual Climate Control System .....	3-36
Wiper Activated Headlamps .....	3-27	Outlet Adjustment .....	3-40
		Passenger Compartment Air Filter .....	3-41

## Section 3 Instrument Panel

---

<b>Warning Lights, Gages, and Indicators</b> .....	3-41	Lights On Reminder .....	3-55
Instrument Panel Cluster .....	3-42	Highbeam On Light .....	3-55
Speedometer and Odometer .....	3-43	Fuel Gage .....	3-56
Trip Odometer .....	3-43	<b>Driver Information Center (DIC)</b> .....	3-57
Tachometer .....	3-43	DIC Operation and Displays .....	3-57
Safety Belt Reminders .....	3-44	DIC Warnings and Messages .....	3-60
Airbag Readiness Light .....	3-44	Other Messages .....	3-70
Passenger Airbag Status Indicator .....	3-45	DIC Vehicle Personalization .....	3-72
Charging System Light .....	3-46	<b>Trip Computer</b> .....	3-76
Voltmeter Gage .....	3-46	Oil Life Indicator .....	3-76
Brake System Warning Light .....	3-47	<b>Audio System(s)</b> .....	3-76
Antilock Brake System (ABS) Warning Light .....	3-48	Bluetooth® .....	3-77
StabiliTrak®/Traction Control System (TCS) Warning Light .....	3-48	Theft-Deterrent Feature .....	3-88
Engine Coolant Temperature Gage .....	3-49	Audio Steering Wheel Controls .....	3-88
Tire Pressure Light .....	3-50	Radio Reception .....	3-90
Malfunction Indicator Lamp .....	3-50	Care of Your CDs .....	3-91
Engine Oil Pressure Gage .....	3-54	Care of the CD Player .....	3-91
Security Light .....	3-55	Diversity Antenna System .....	3-91
Fog Lamp Light .....	3-55	XM™ Satellite Radio Antenna System .....	3-91



# Instrument Panel Overview

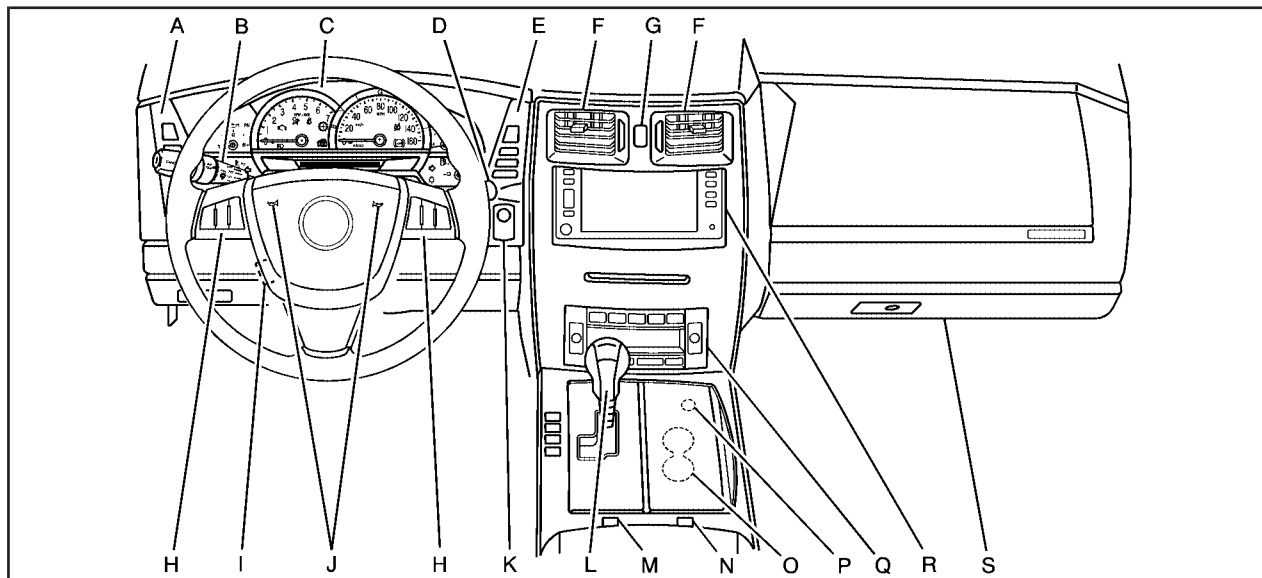

XLR shown, XLR-V similar

The main components of the instrument panel are the following:

- A. *Head-Up Display (HUD) on page 3-31 or Instrument Panel Brightness on page 3-30.*
- B. *Turn Signal/Multifunction Lever on page 3-7. Cruise Control on page 3-11. Exterior Lamps on page 3-26. Fog Lamps on page 3-28.*
- C. *Instrument Panel Cluster on page 3-42.*
- D. *Windshield Wipers on page 3-8 and Windshield Washer on page 3-10.*
- E. *Driver Information Center (DIC) Controls/Interior Lamps. See DIC Operation and Displays on page 3-57.*
- F. *Outlet Adjustment on page 3-40.*
- G. *Hazard Warning Flashers on page 3-6.*
- H. *Audio Steering Wheel Controls on page 3-88. Adaptive Cruise Control on page 3-14 (If Equipped). Heated Steering Wheel on page 3-7. Voice Commands. See OnStar<sup>®</sup> System on page 2-42.*
- I. *Power Tilt Wheel and Telescopic Steering Column on page 3-6.*
- J. *Horn on page 3-6.*
- K. *Ignition Positions on page 2-24.*
- L. *Shift Lever. See Automatic Transmission Operation on page 2-28.*
- M. *Traction Control System (TCS) on page 5-8.*
- N. *Retractable Hardtop on page 2-54.*
- O. *Cupholders on page 2-53.*
- P. *Cigarette Lighter. See Ashtray(s) and Cigarette Lighter on page 3-35.*
- Q. *Dual Climate Control System on page 3-36.*
- R. *Audio/Navigation System. See Navigation System Overview on page 4-2.*
- S. *Glove Box on page 2-53.*

## Hazard Warning Flashers

The hazard warning flashers warns others that you have a problem. The button is located near the center of the instrument panel.

 : Press to make the front and rear turn signal lamps flash on and off. Press again to turn the flashers off.

The hazard warning flashers work no matter what mode the ignition is in, even if the ignition is turned off.

When the hazard warning flashers are on, the turn signals will not work.

## Horn

Press near or on the horn symbols on the steering wheel pad to sound the horn.

## Power Tilt Wheel and Telescopic Steering Column

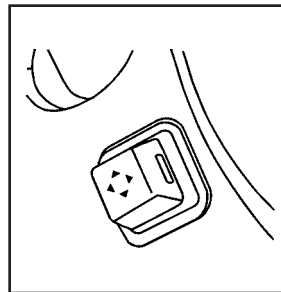

The power tilt and telescope wheel control is located on the outboard side of the steering column.

To operate the power tilt feature, push the control up and the steering wheel tilts up. Push the control down and the steering wheel goes down.

Push the control forward and the steering wheel moves toward the front of the vehicle. Push the control rearward and the steering wheel moves toward the rear of the vehicle. To set the memory position, see *DIC Vehicle Personalization on page 3-72* and *Memory Seat, Mirrors and Steering Wheel on page 1-3*.



## Heated Steering Wheel

For vehicles with a heated steering wheel, the button for this feature is located on the steering wheel.

 : Press to turn the heated steering wheel on or off. A light on the button displays when the feature is turned on.

The steering wheel takes about three minutes to start heating.

## Turn Signal/Multifunction Lever

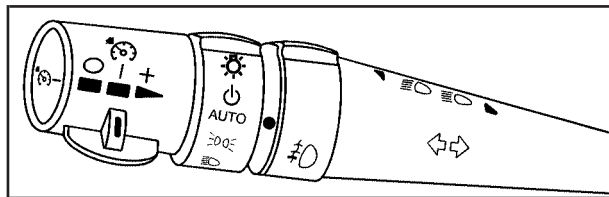

The lever on the left side of the steering column includes the following:

 : Turn and Lane-Change Signals

 : Headlamp High/Low-Beam Changer

 : Fog Lamps

 : Cruise Control

 : Exterior Lamps Control

- Flash-to-Pass Feature. See *Flash-to-Pass* on page 3-8.

Information for these features is on the pages following.

## Turn and Lane-Change Signals

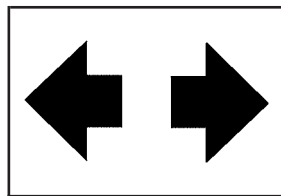

An arrow on the instrument panel cluster flashes in the direction of the turn or lane change.

Move the multifunction lever all the way up or down to signal a turn.

Raise or lower the lever until the arrow starts to flash to signal a lane change. Hold it there until the lane change is complete.

The lever returns to its starting position whenever it is released.

If after signaling a turn or a lane change the arrows flash rapidly or do not come on, a signal bulb could be burned out.

Have the bulbs replaced. If the bulb is not burned out, check the fuses. See *Fuses and Circuit Breakers* on page 6-83.

## Turn Signal on Chime

A chime will remind you if the turn signal is left on for more than 3/4 mile (1.2 km) of driving.

If you need to leave the turn signal on for more than 3/4 mile (1.2 km), turn off the signal and then turn it back on.

## Headlamp High/Low-Beam Changer

Push the turn signal lever all the way forward to change the headlamps from low beam to high beam.

When the high beams are on, this light  appears on the instrument panel cluster.

Pull the lever rearward to change the headlamps back to low beam.

## Flash-to-Pass

This feature lets you use the high-beam headlamps to signal the driver in front of you that you want to pass. Pull and hold the turn signal lever toward you to use. When you do, the following will occur:

- If the low-beam headlamps are on, the high-beam headlamps will turn on. They will stay on as long as you hold the lever there. Release the lever to turn them off.
- If the headlamps are on high-beam, they will switch to low-beam. To return to high beam, push the lever away from you.

## Windshield Wipers

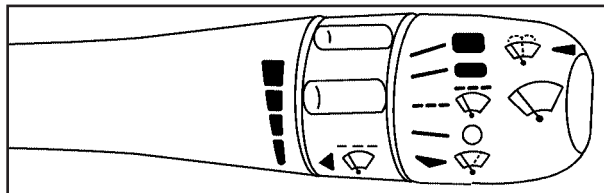

The windshield wiper lever is located on the right side of the steering column.

Move the lever to the following positions:

 **(High Speed):** For steady wiping at high speed.

 **(Low Speed):** For steady wiping at low speed.

 **(Delay):** Use to set a delay between wipes.

 **(Delay Adjustment):** Use for a delayed wiping cycle. Turn the intermittent adjust band down for a longer delay or up for a shorter delay. The wiper speed can only be manually adjusted when the lever is in this position.

 **(Off):** Turns off the windshield wipers.

 **(Mist):** Move all the way down to mist and release for a single wiping cycle. The windshield wipers will stop after one wipe. Hold the band on mist longer for more wipes.

Heavy snow or ice can overload the wipers. If this occurs, a circuit breaker will stop the wipers until the motor cools. Clear all ice and snow from the windshield wiper blades before using them. If the wiper blades are frozen to the windshield, carefully loosen them or warm the windshield before turning the wipers on. If they become worn or damaged, get new blades or blade inserts.

## Rainsense™ Wipers

With Rainsense wipers, there is a moisture sensor mounted on the interior side of the windshield below the rearview mirror, and it automatically operates the wipers by monitoring the amount of moisture build-up on the windshield. Wipes occur as needed to clear the windshield depending on driving conditions and the sensitivity setting. In light rain or snow, fewer wipes will occur. In heavy rain or snow, wipes will occur more frequently. The Rainsense wipers operate in a delay mode as well as a continuous low or high speed as needed. If the system is left on for long periods of time, occasional wipes may occur without any moisture on the windshield. This is normal and indicates that the Rainsense system is activated.

The Rainsense system is also sensitive to vibration. The system may activate if something hits the windshield or if the vehicle hits a bump.

The Rainsense system can be activated by moving the wiper lever up to the delay position and turning the delay adjust band to one of the five sensitivity levels. The bottom delay adjust position is the lowest sensitivity setting, level one. This allows more rain or snow to collect on the windshield between wipes. Turning the delay adjust band away from you to the higher sensitivity levels allows less rain or snow to collect on the windshield between wipes.

The top position is the highest sensitivity setting, level five. A single wipe will occur each time the delay adjust band is turned to a higher sensitivity level to indicate that the sensitivity level has been increased.

**Notice:** Going through an automatic car wash with the wipers on can damage them. Turn the wipers off when going through an automatic car wash.

The mist and wash cycles operate as normal and are not affected by the Rainsense function. The Rainsense system can be overridden at any time by manually changing the wiper control to low or high speed.

When Rainsense is active, the headlamps will turn on automatically. If it is dark, they will remain on. See “Wiper-Activated Headlamps” under *Exterior Lamps on page 3-26* for more information.

**Notice:** Do not place stickers or other items on the exterior glass surface directly in front of the moisture sensor. Doing this could cause the moisture sensor to malfunction.

## Windshield Washer



**(Washer Fluid):** The lever on the right side of the steering column also controls the windshield washer. There is a button at the end of the lever. To spray washer fluid on the windshield, press the button and hold it. The washer will spray until you release the button. The wipers will continue to clear the window for about six seconds after the button is released and then stop or return to your preset speed.

### CAUTION:

In freezing weather, do not use your washer until the windshield is warmed. Otherwise the washer fluid can form ice on the windshield, blocking your vision.

If the fluid in the windshield washer fluid reservoir is low, the message LOW WASHER FLUID will appear on the Driver Information Center (DIC) display. It will take 60 seconds after the bottle is refilled for this message to turn off. For information on the correct washer fluid mixture to use, see *Windshield Washer Fluid on page 6-31* and *Recommended Fluids and Lubricants on page 7-11*.

## Headlamp Washer

The headlamps washer only functions every fourth time the washer button is pressed and if the headlamps are on.

## Cruise Control

With cruise control, a speed of about 25 mph (40 km/h) or more can be maintained without keeping your foot on the accelerator. Cruise control does not work at speeds below about 25 mph (40 km/h).

Cruise control will not work if the parking brake is set, or if the master cylinder brake fluid level is low.

### CAUTION:

Cruise control can be dangerous where you cannot drive safely at a steady speed. So, do not use the cruise control on winding roads or in heavy traffic.

Cruise control can be dangerous on slippery roads. On such roads, fast changes in tire traction can cause excessive wheel slip, and you could lose control. Do not use cruise control on slippery roads.

If the vehicle has the traction control system and it begins to limit wheel spin while cruise control is on, the cruise control will automatically disengage. See *Traction Control System (TCS) on page 5-8*. When road conditions allow cruise control to be safely used again, it can be turned back on.

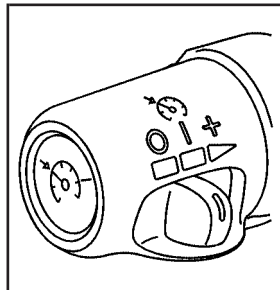

 **(Off):** Turns the system off.

**I (On):** Turns the system on.

**+ (Resume/Accelerate):** Makes the vehicle accelerate or resume to a previously set speed.

 **(Set):** Press this button at the end of the lever to set the speed.

## Setting Cruise Control

### CAUTION:

If you leave your cruise control on when you are not using cruise, you might hit a button and go into cruise when you do not want to. You could be startled and even lose control. Keep the cruise control switch off until you want to use cruise control.

1. Move the cruise control switch to on.
2. Get up to the speed desired.
3. Press the set button at the end of the lever and release it.
4. Take your foot off the accelerator pedal.

This light  appears on the instrument panel cluster when the cruise control is engaged.

## Resuming a Set Speed

If the cruise control is set at a desired speed and the brake is applied, the cruise control will turn off. It does not need to be reset

Once the vehicle is going about 25 mph (40 km/h) or more, move the cruise control switch briefly from | to + .

The vehicle will go back up to the chosen speed and stay there.

If the switch is held at resume/accelerate the vehicle will keep going faster until the switch is released or the brake is applied. Do not hold the switch at resume/accelerate, unless you want the vehicle to go faster.

## Increasing Speed While Using Cruise Control

There are two ways to increase speed:

- Use the accelerator pedal to get to the higher speed. Press  at the end of the lever, then release the button and the accelerator pedal. The vehicle will now cruise at the higher speed. If the accelerator pedal is held longer than 60 seconds, cruise control will turn off.
- Move the cruise switch from | to + . Hold it there until the desired speed is reached, and then release the switch. To increase the vehicle speed in small amounts, move the switch briefly to resume/accelerate. Each time this is done, the vehicle goes about 1 mph (1.6 km/h) faster.

## Reducing Speed While Using Cruise Control

- Press and hold the set button until the lower speed desired is reached, then release it.
- To slow down in small amounts, briefly press the set button. Each time this is done, the vehicle goes about 1 mph (1.6 km/h) slower.

## Passing Another Vehicle While Using Cruise Control

Use the accelerator pedal to increase the vehicle speed. When you take your foot off the pedal, the vehicle slows down to the cruise control speed set earlier.

## Using Cruise Control on Hills

How well your cruise control works on hills depends upon the vehicle speed, load and the steepness of the hills. When going up steep hills, you might have to step on the accelerator pedal to maintain your speed. When going downhill, you might have to brake or shift to a lower gear to keep your vehicle's speed down. When the brakes are applied the cruise control turns off.

## Ending Cruise Control

There are two ways to turn off the cruise control:

- Step lightly on the brake pedal
- Move the cruise control switch to 

## Erasing Speed Memory

The cruise control set speed memory is erased when the cruise control or the ignition is turned off.

## Adaptive Cruise Control

If the vehicle has this feature, be sure to read this entire section before using it.

The system operates on a radio frequency subject to Federal Communications Commission (FCC) Rules and with Industry Canada.

This device complies with Part 15 of the FCC Rules. Operation is subject to the following two conditions:

1. This device may not cause interference.
2. This device must accept any interference received, including interference that may cause undesired operation of the device.

This device complies with RSS-210 of Industry Canada. Operation is subject to the following two conditions:

1. This device may not cause interference.
2. This device must accept any interference received, including interference that may cause undesired operation of the device.

Changes or modifications to this system by other than an authorized service facility could void authorization to use this equipment.

Adaptive Cruise Control is an enhancement to traditional cruise control and is not a safety system. It allows you to keep cruise control engaged in moderate traffic conditions without it having to be constantly reset. Adaptive Cruise Control uses radar to detect a vehicle directly ahead in your path, within a distance of 328 ft (100 m), and operates at speeds above 25 mph (40 km/h). When it is engaged by the driver, the system can apply limited braking or acceleration of the vehicle, automatically, to maintain a selected following distance to the vehicle ahead. The vehicle's braking during Adaptive Cruise Control is comparable to a person applying moderate pressure to the vehicle's brake pedal. To disengage Adaptive Cruise Control, apply the brake. If no vehicle is in your path, your vehicle will react like traditional cruise control.



 **CAUTION:**

Adaptive Cruise Control will not apply hard braking or bring the vehicle to a complete stop. It will not respond to stopped vehicles, pedestrians or animals. When you are approaching a vehicle or object, Adaptive Cruise Control may not have time to slow your vehicle enough to avoid a collision. Your complete attention is always required while driving and you should be ready to take action and apply the brakes. For more information, see *Defensive Driving on page 5-2*.

 **CAUTION:**

- On winding roads, Adaptive Cruise Control may not detect a vehicle ahead. You could crash into a vehicle ahead of you. Do not use Adaptive Cruise Control on winding roads.

CAUTION: (Continued)

**CAUTION: (Continued)**

- Adaptive Cruise Control may not have time to slow your vehicle enough to avoid a crash when you are driving in conditions where vehicles may suddenly slow or stop ahead of you, enter your lane, or cross your vehicle's path. If you are driving in these conditions, do not use Adaptive Cruise Control. The warning beep and alert symbol may indicate that you are driving in conditions where Adaptive Cruise Control should not be used. See "Alerting the Driver" in this section.
- On slippery roads, fast changes in tire traction can cause needless wheel spinning, and you could lose control. Do not use cruise control on slippery roads.
- When weather limits visibility, such as when in fog, rain, or snow conditions, Adaptive Cruise Control performance is limited. There may not be enough distance to adapt to the changing traffic conditions. Do not use cruise control when visibility is low.

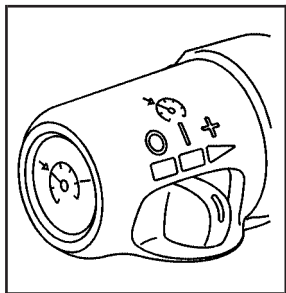

The cruise controls are located on the end of the multifunction lever.

The Adaptive Cruise controls are located on the outboard side of the steering wheel.

○ **(Off):** Turns the system off.

| **(On):** Turns the system on.

+ **(Resume/Increase):** Push the switch to this symbol to make the vehicle resume the speed set previously or to increase the set speed when Adaptive Cruise Control is already active.

⊖ **(Set/Decrease):** Press to set the speed or to decrease the set speed when Adaptive Cruise Control is already active.

⊗ **(Cancel):** Press this button located on the steering wheel to cancel Adaptive cruise control.

## Engaging Adaptive Cruise Control With the Set Button

### ⚠ CAUTION:

If you leave your Adaptive Cruise Control switch on when you are not using cruise, you might hit a button and go into cruise when you do not want to. You could be startled and even lose control. Keep the Adaptive Cruise Control switch off until you want to use cruise control.

### ⚠ CAUTION:

If you operate Adaptive Cruise Control without your Head-up Display (HUD) properly adjusted, your Adaptive Cruise Control settings may not be visible. You could forget your settings and be startled by Adaptive Cruise Control response and even lose control. Keep your HUD on and properly adjusted when using Adaptive Cruise Control.

The set speed is selected by the driver. This is the speed you will travel if there is no vehicle detected in your path.

To set Adaptive Cruise Control, do the following:

1. Make sure the Head-Up Display (HUD) is on and properly adjusted. You cannot engage Adaptive Cruise Control unless the HUD is on. See *Head-Up Display (HUD)* on page 3-31 for more information.
2. Move the switch to the on position.
3. Get up to the desired speed.
4. Press  at the end of the lever and release the button.
5. Take your foot off the accelerator pedal.

Once Adaptive Cruise Control is set, it might immediately apply the brakes if it detects a vehicle ahead that is too close or moving slower than your vehicle.

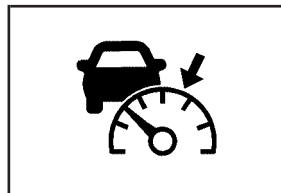

This symbol appears on the Head-Up Display (HUD) to indicate that Adaptive Cruise Control is active.

See *Head-Up Display (HUD)* on page 3-31 for more information.

Make sure the set speed is visible on the HUD so you know the speed your vehicle will accelerate to if a vehicle is not detected in your path. Keep in mind speed limits, surrounding traffic speeds, and weather conditions when adjusting your set speed.

If the vehicle is in Adaptive Cruise Control when the traction control system begins to limit wheel spin, the Adaptive Cruise Control automatically disengages. See *Traction Control System (TCS)* on page 5-8 and *StabiliTrak® System* on page 5-6. When road conditions allow you to safely use it again, the Adaptive Cruise Control can be turned back on.

## Increasing Set Speed While Using Adaptive Cruise Control

There are two ways to increase the set speed:

- Use the accelerator to get to the higher speed.  
Press  at the end of the lever, then release the button and the accelerator pedal. The vehicle will now cruise at the higher speed.
- Move the Adaptive Cruise Control switch from | to + . Hold it there until the desired set speed is displayed in the HUD, then release the switch. To increase the set speed in small amounts, move the switch briefly to resume/increase. Each time this is done, the vehicle set speed increases by about 1 mph (1.6 km/h).

Your vehicle will not reach the set speed until the system determines there is no vehicle in front of you. At that point, your vehicle speed will increase to the set speed.

## Decreasing Set Speed While Using Adaptive Cruise Control

Press  on the end of the lever until the lower desired speed is reached, then release the button.

To slow down in small amounts, briefly press  . Each time this is done, the set speed will be 1 mph (1.6 km/h) slower.

## Resuming a Set Speed

If the brakes are applied while the Adaptive Cruise Control is at a set speed, this disengages the Adaptive Cruise Control. But it does not need to be reset.

Once the vehicle reaches about 25 mph (40 km/h) or more, move the Adaptive Cruise Control switch briefly from | to + . Adaptive Cruise Control will be engaged with the speed selected previously.

## Selecting the Follow Distance (GAP)

When the system detects a slower moving vehicle, it will adjust your vehicle's speed and maintain the following distance (gap) selected.

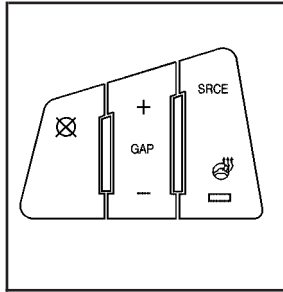

Use the GAP button on the steering wheel to adjust the follow distance between your vehicle and other vehicles.

Press the top of the button to increase the distance or the bottom of the button to decrease the distance. The first button press shows the current follow distance setting on the HUD. The current following distance setting is maintained until it is changed.

There are six follow distances to choose from. The follow distance selection ranges from near to far (1 second to 2 seconds follow time). The distance maintained for a selected follow distance varies based on vehicle speed. The faster the vehicle speed the

further back you will follow. Consider traffic and weather conditions when selecting the follow distance. The range of selectable distances may not be appropriate for all drivers and driving conditions. If you prefer to travel at a following distance farther than Adaptive Cruise Control allows, disengage the system and drive manually.

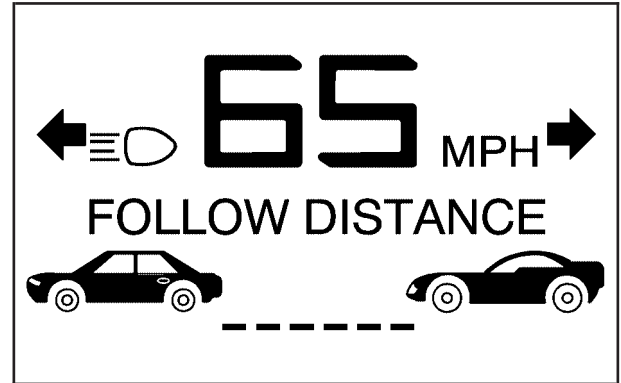

A graphic on the HUD indicates the selected following distance. This picture shows a maximum following distance. The vehicles will move closer together as you select a smaller following distance.

## Alerting the Driver

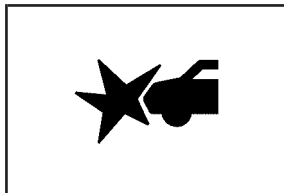

This symbol flashes on the HUD and a warning beep sounds when driver action is required.

Driver action is required when:

- Adaptive Cruise Control cannot apply sufficient braking because you are approaching a vehicle too rapidly.
- The vehicle speed drops below about 20 mph (32 km/h).
- A temporary condition prohibits Adaptive Cruise Control from operating. See *DIC Warnings and Messages on page 3-60* for more information.
- A malfunction is detected in the system. See *DIC Warnings and Messages on page 3-60* for more information.

See *Defensive Driving on page 5-2*.

## CAUTION:

Adaptive Cruise Control has only limited braking ability to slow your vehicle. In some cases, Adaptive Cruise Control may not have time to slow your vehicle enough to avoid a collision. Be ready to take action and apply the brakes yourself. See *Defensive Driving on page 5-2*.

## Approaching and Following a Vehicle

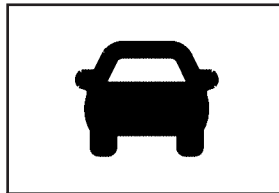

This symbol only appears on the HUD when a vehicle ahead is detected in your path.

If this symbol does not appear, or disappears briefly, Adaptive Cruise Control will not respond to vehicles you may see ahead.

 **CAUTION:**

When the Adaptive Cruise Control radar is blocked by snow, ice, or dirt, it may not detect a vehicle ahead. Adaptive Cruise Control may not have time to slow your vehicle enough to avoid a collision. Do not use Adaptive Cruise Control when the radar is blocked by snow, ice, or dirt. Keep your radar clean. See “Cleaning the System” later in this section.

Adaptive Cruise Control automatically slows the vehicle down when approaching a slower moving vehicle. It then adjusts your speed to follow the vehicle in front at the selected following distance. Your speed increases or decreases to follow the vehicle in front of you, but will not exceed the set speed. It may apply limited braking, if necessary. When braking is active, the brake lights come on. It may feel or sound different than if you were applying the brakes yourself. This is normal.

## Stationary or Very Slow-Moving Objects

 **CAUTION:**

Adaptive Cruise Control may not detect and react to stationary or slow-moving vehicles or other objects ahead of you. You could crash into an object ahead of you. Do not use Adaptive Cruise Control when approaching stationary or slow-moving vehicles or other objects.

 **CAUTION:**

Adaptive Cruise Control may not detect and react to stationary or slow-moving vehicles or other objects ahead of you. Your vehicle may accelerate toward objects, such as a stopped vehicle that suddenly appears after the lead vehicle changes lanes. Your complete attention is always required while driving and you should be ready to take action and apply the brakes.

## Low-Speed Deactivation

If your speed falls below 20 mph (32 km/h) while following a vehicle ahead, Adaptive Cruise Control begins to disengage. The driver alert symbol on the HUD flashes and the warning beep sounds. The driver must take action since Adaptive Cruise Control will not slow the vehicle to a stop.

## Passing a Vehicle

To increase speed to pass a vehicle, use the accelerator pedal. While your foot is on the accelerator pedal, the system will not automatically apply the brakes. Once you pass the vehicle and remove your foot from the accelerator pedal, Adaptive Cruise Control returns to normal operation and the brakes can be applied, if needed.

### CAUTION:

If you rest your foot on the accelerator pedal, the system will not automatically apply the brakes. You could crash into a vehicle ahead of you. Do not rest your foot on the accelerator pedal when using Adaptive Cruise Control.

## Curves in the Road

### CAUTION:

Due to Adaptive Cruise Control limitations in curves, it may respond to a vehicle in another lane, or may not have time to react to a vehicle in your lane. You could crash into a vehicle ahead of you, or lose control of your vehicle. Give extra attention in curves and be ready to use the brakes if necessary. Select an appropriate speed while driving in curves.

Adaptive Cruise Control might operate differently in a sharp curve. It might reduce your speed if the curve is too sharp. The TIGHT CURVE message will also display on the HUD. See *Head-Up Display (HUD)* on page 3-31 for more information.



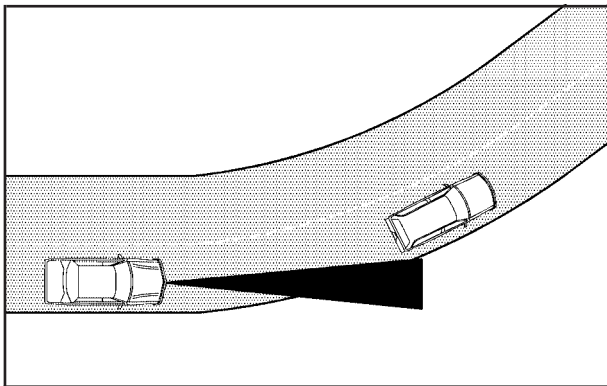

When following a vehicle and entering a curve, Adaptive Cruise Control could lose track of the vehicle in your lane and accelerate your vehicle. When this happens, the vehicle ahead symbol will not appear on the HUD.

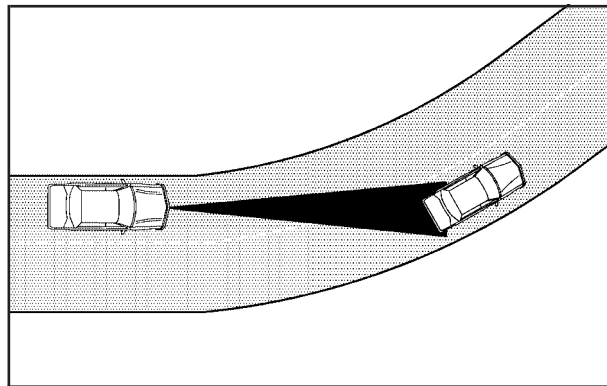

Adaptive Cruise Control might detect a vehicle that is not in your lane and apply the brakes.

Adaptive Cruise Control might occasionally provide a driver alert and/or braking that you consider unnecessary. It could respond to signs, guardrails, and other stationary objects when entering or exiting a curve. This is normal operation. Your vehicle does not need service.

## Highway Exit Ramps

### CAUTION:

Adaptive Cruise Control may lose track of the vehicle ahead and accelerate up to your set speed while entering or on highway exit ramps. You could be startled by this acceleration and even lose control of the vehicle. Disengage Adaptive Cruise Control before entering a highway exit ramp. Do not use Adaptive Cruise Control while entering or on exit ramps.

## Other Vehicle Lane Changes

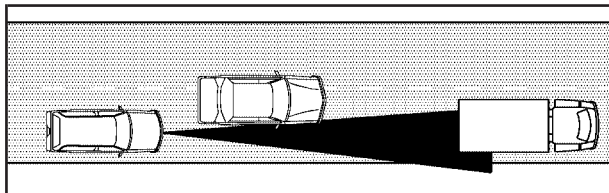

If another vehicle enters the same lane as you, Adaptive Cruise Control will not detect the vehicle until it is completely in the lane. Be ready to take action and apply the brakes yourself.

## Using Adaptive Cruise Controls on Hills

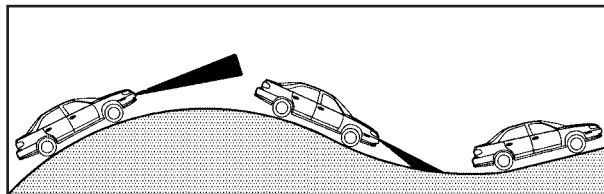

How well Adaptive Cruise Control works on hills depends on your speed, vehicle load, traffic conditions, and the steepness of the hills. It might not detect a vehicle in your lane while driving on hills. While going up steep hills, you might want to use the accelerator pedal to maintain your vehicle speed. While going downhill, you might have to brake to keep your vehicle speed down. Applying the brake disengages the system. You may choose not to use Adaptive Cruise Control on steep hills.

## Disengaging Adaptive Cruise Control

Apply the brake pedal or move the Adaptive Cruise Control switch to off, to disengage the system. Adaptive Cruise Control information does not appear on the HUD while the system is not engaged.

## Erasing Set Speed Memory

The set speed memory is erased when the Adaptive Cruise Control switch or the ignition is turned off.

## Other Messages

There are three messages that may appear on the DIC. They are SERVICE RADAR CRUISE, CRUISE NOT READY and CLEAN RADAR CRUISE. These messages will only appear to indicate a problem with the Adaptive Cruise Control. See *DIC Warnings and Messages on page 3-60* for more information.

You may also see CRUISE SPEED LIMITED displayed in the HUD. See *Head-Up Display (HUD) on page 3-31* for more information.

## Cleaning the System

The radar can become blocked by snow, ice, or dirt. If so, you may need to turn off the engine and clean the lens, located on the driver side of the front fascia.

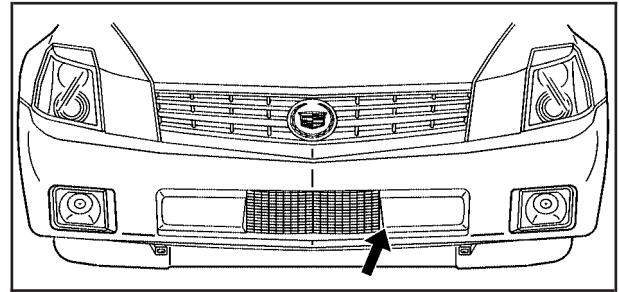

Clean the surface with a 50/50 mixture of isopropyl alcohol and water on a dampened cloth. After cleaning the fascia lens, try to engage Adaptive Cruise Control. If this does not fix the problem, you may have to remove the fascia lens and clean the inside of the fascia lens and radar lens.

To clean the inside of the fascia lens and radar lens, insert a tool into one of the small slots on the inboard side of the lens and pop the lens out. Clean the surface with a 50/50 mixture of isopropyl alcohol and water on a dampened cloth. After cleaning the lens, set the lens back in place and press until it snaps in place.

## Exterior Lamps

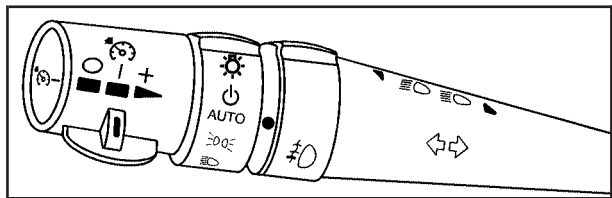

The exterior lamp control is located to the left of the steering wheel on the multifunction lever.

 **(Exterior Lamp Control):** Turn the band to operate the exterior lamps.

There are four positions:

 **(Off):** Turns off all lamps.

**AUTO (Automatic):** Sets the exterior lamps to automatic mode. AUTO mode will turn the exterior lamps on and off depending on how much light is available outside the vehicle. Turning the band to AUTO mode also enables the Adaptive Forward Lighting system. See *Adaptive Forward Lighting System* on page 3-28.

To override AUTO mode, turn the control to off.

To reset to AUTO mode turn the control to exterior lamps and then back to AUTO. Automatic mode will also reset when your vehicle is turned off and then back on again when the control is left in the AUTO position.

See *Twilight Sentinel<sup>®</sup>* on page 3-29.

 **(Parking Lamp):** Turns on the parking lamps together with the following:

- Sidemarkers Lamps
- Taillamps
- License Plate Lamps
- Instrument Panel Lights

The parking brake indicator light will come on and stay on when the parking lamps are on with the engine off and the ignition to ACC/ACCESSORY.

 **(Headlamps):** Turns on the headlamps, together with the previously listed lamps and lights.

## Wiper Activated Headlamps

This feature activates the headlamps and parking lamps after the windshield wipers have been in use for approximately six seconds and the multifunction lever is in the AUTO position. See *Exterior Lamps on page 3-26*.

When the exterior lamp control has been turned off or is in the parking lamp position and the wiper control is on delay, low speed or high speed, the HEADLAMPS SUGGESTED message will appear on the Driver Information Center (DIC).

When the ignition is turned off, the wiper-activated headlamps will immediately turn off.

## Headlamps on Reminder

A warning chime will sound if the exterior lamp control is left on in either the headlamp or parking lamp position and the driver's door is opened with the ignition off.

## Daytime Running Lamps (DRL)

Daytime Running Lamps (DRL) can make it easier for others to see the front of your vehicle during the day. Fully functional DRL are required on all vehicles first sold in Canada.

The DRL system comes on when the following conditions are met:

- It is still daylight and the ignition is on.
- The exterior lamp control is in the off position.
- The transmission is not in P (Park).

When DRL are on, only the front turn signal lamps are on. No other exterior lamps such as the parking lamps, taillamps, etc. are on when the DRL are used. The instrument panel is not lit up either.

When it is dark enough outside, the front turn signal lamps turn off and normal low-beam headlamps turn on.

When it is bright enough outside, the regular lamps go off, and the front turn signal lamps take over. If the vehicle is started in a dark garage, the automatic headlamp system comes on immediately. Once the vehicle leaves the garage, it takes about one minute for the automatic headlamp system to change to DRL if it is light outside. During that delay, the instrument panel cluster might not be as bright as usual. Make sure the instrument panel brightness knob is in the full bright position. See *Instrument Panel Brightness on page 3-30* for more information.

If it is dark enough outside and the exterior lamp control is off, a HEADLAMPS SUGGESTED message displays on the Driver's Information Center (DIC). This message informs the driver that turning on the exterior lamps is recommended. See *DIC Warnings and Messages on page 3-60*.

Turn the exterior lamp control off a second time, or turn on the headlamps to turn off the HEADLAMPS SUGGESTED message in the DIC. If the parking lamps or the fog lamps were turned on instead, the HEADLAMPS SUGGESTED message continues to display.

The regular headlamp system should be turned on when needed.

## Adaptive Forward Lighting System

The Adaptive Forward Lighting System (AFS) swivels the headlamps horizontally to provide greater road illumination while turning. AFS will operate when the vehicle speed is greater than 2 mph (3 km/h). AFS will not operate when the transmission is in R (Reverse). AFS is not immediately operable after starting the vehicle; driving a short distance is required to calibrate

the AFS. To enable AFS, set the exterior lamp switch on the multifunction lever to the AUTO position. Moving the switch out of the AUTO position will deactivate the system. See *Exterior Lamps on page 3-26*.

## Fog Lamps

Use fog lamps for better vision in foggy or misty conditions.

The fog lamps control is located on the multifunction lever next to the exterior lamp control.

 **(Fog Lamps):** Turn the band to turn the fog lamps on.

The fog lamp light appears on the instrument panel cluster to indicate that the fog lamps and the parking lamps are on.

If you turn the high-beam headlamps on, the fog lamps will turn off. They will turn on again when you switch to low-beam headlamps.

The ignition must be on for the fog lamps to operate. The fog lamps will turn off when the ignition is turned off.

Some localities have laws that require the headlamps to be on along with the fog lamps.

## Twilight Sentinel®

This feature can turn the lamps on and off for you. A light sensor on top of the instrument panel makes the Twilight Sentinel® work, so be sure it is not covered.

With Twilight Sentinel® you will see the following happen:

- When it is dark enough outside, the front turn signal lamps (DRL) will go off, and the headlamps and parking lamps will come on. The other lamps that come on with headlamps will also come on.
- When it is bright enough outside, the headlamps will go off, and the front turn signal lamps (DRL) will come on, as long as the exterior lamp switch is in the AUTO position.

If the vehicle is started in a dark garage, the automatic headlamp system will come on immediately. Once the vehicle leaves the garage, it takes about one minute for the automatic headlamp system to change to DRL if it is light outside. During that delay, the instrument panel cluster may not be as bright as usual. Make sure the instrument panel brightness control is in full bright position. See *Instrument Panel Brightness on page 3-30* for more information.

You can idle the vehicle with the lamps off, even when it is dark outside. After starting the vehicle, turn the exterior lamp control band to off, then release it. The lamps will remain off until you turn the control band to off again.

Twilight Sentinel® also provides exterior illumination as you leave the vehicle. If Twilight Sentinel® has turned on the lamps when you turn off the ignition, the lamps will remain on until:

- The exterior lamp switch is moved from OFF to the parking lamp position, or
- the delay time selected has elapsed.

See *Driver Information Center (DIC) on page 3-57* to select the delay time. You can also select no delay time.

If the ignition is turned off with the exterior lamp switch in the parking lamp or headlamp position, the Twilight Sentinel® delay will not occur. The lamps will turn off as soon as the switch is turned off.

The regular headlamp system should be turned on when needed.

## Exterior Lighting Battery Saver

If the manual parking lamps or headlamps have been left on, the exterior lamps will turn off as soon as the ignition is turned off or Retained Accessory Power (RAP) is active. This protects against draining the battery in case you have accidentally left the headlamps or parking lamps on. The battery saver does not work if the headlamps are turned on after the ignition switch is turned to off.

If you need to leave the lamps on, use the exterior lamp control to turn the lamps back on.

## Instrument Panel Brightness

The button for this feature is located on the instrument panel to the left of the steering column.

**+☀ - (Brightness):** Press to change the brightness of the instrument panel lights.

Press the DIMMER button until PANEL DIMMING appears on the Driver Information Center (DIC). Then use the brightness button to adjust the instrument panel brightness. Press the top or bottom of the button to brighten or dim the lights. See *Head-Up Display (HUD) on page 3-31* for more information.

Be sure not to have the brightness turned all the way down with the lamps on during the day. The DIC may not be visible.

## Courtesy Lamps

When any door or the trunk lid is opened, the interior lamps will go on unless it is bright outside.

Press the interior lamp button on the right side of the instrument panel, to turn the courtesy lamps on or off.

## Entry/Exit Lighting

With entry lighting, the interior lamps will come on when entering the vehicle. The interior lamps will come on for about 20 seconds when the engine is turned off.

You can turn exit and entry lighting off by quickly turning the courtesy lamps on and off.

## Reading Lamps

The inside rearview mirror includes two reading lamps. The lamps will go on when a door is opened. When the doors are closed, each lamp can be turned on individually by pressing the button for that lamp.



## Battery Run-Down Protection

The vehicle has a feature to help prevent the battery from being drained, in case the underhood lamp, vanity mirror lamps, cargo lamps, reading lamps, console, or glove box lamps are accidentally left on, or something is left plugged into the accessory power outlet or cigarette lighter. If any of the accessory lamps are left on, they will automatically time-out after about 10 minutes. To reset the battery protection, all of the above lamps must be turned off or the ignition must be in the ACC/ACCESSORY position.

## Head-Up Display (HUD)

### CAUTION:

If the HUD image is too bright, or too high in your field of view, it may take you more time to see things you need to see when it is dark outside. Be sure to keep the HUD image dim and placed low in your field of view.

The Head-Up Display (HUD) allows you to see some of the driver information that appears on the instrument panel cluster.

The information may be displayed in English or metric units and appears as an image focused out toward the front of the vehicle. To change from English to metric units, see *Driver Information Center (DIC) on page 3-57*.

The HUD consists of the following information:

- Speedometer
- Turn Signal Indicators
- High-Beam Indicator Symbol
- Tap-Up/Tap-Down Transmission Feature
- Check Gages Message
- Adaptive Cruise Control Features and Indicators
- Radio Features



Continue to scan the displays, controls and driving environment just as you would in a vehicle without HUD. Check the instrument panel cluster, to be sure you do not miss something important, such as a warning light. Under important warning conditions, the CHECK GAGES message will display in the HUD. View the Driver Information Center (DIC) for more information.

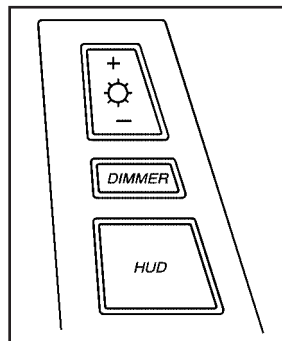

The HUD controls are located to the left of the steering wheel.

**+☀ - (Brightness):** Use to adjust the brightness of the HUD and the instrument panel cluster.

**DIMMER:** Use to select the HUD or the instrument panel cluster to adjust the brightness.

**HUD:** Use to adjust the vertical position of the HUD display.

To adjust the HUD so you can see it properly, do the following:

1. Adjust the seat to a comfortable driving position. If you change the seat position later, you may have to re-adjust the HUD.
2. Start the engine and press the top or bottom of the HUD button to center the HUD image in your view.

The HUD image can only be adjusted up and down, not side-to-side.

3. Press the DIMMER button until the DIC reads HUD DIMMING. Then use the brightness button to adjust the desired intensity.

The brightness of the HUD image is determined by the light conditions in the direction the vehicle is facing and where you have the HUD set. If you are facing a dark object or a heavily shaded area, the HUD may anticipate that you are entering a dark area and may begin to dim.

To turn off the HUD, press the brightness button down until the image disappears.

Polarized sunglasses could make the HUD image harder to see.

As light shines out from the HUD, it is possible for light to shine back in. In rare occurrences, when the sun is at a specific angle and position, the sun's rays can

shine back into the HUD. When this occurs, the display device within the HUD will be temporarily illuminated. The event will end when the vehicle's angle to the sun changes.

Clean the inside of the windshield as needed to remove any dirt or film that reduces the sharpness or clarity of the HUD image.

To clean the HUD, spray household glass cleaner on a soft, clean cloth. Wipe the HUD lens gently, then dry it. Do not spray cleaner directly on the lens because the cleaner could leak into the unit.

If the ignition is on and you cannot see the HUD image, check to see if:

- Something is covering the HUD unit.
- The brightness is adjusted properly.
- The HUD image is adjusted to the proper height.
- Ambient light in the direction the vehicle is facing is low.
- A fuse is blown. See *Fuses and Circuit Breakers on page 6-83*.

Keep in mind that the windshield is part of the HUD system. See *Windshield Replacement on page 6-45*.

The following Adaptive Cruise Control (ACC) messages may appear in the HUD:

**CRUISE SPEED LIMITED:** This message indicates that the vehicle speed has been reduced below the set speed due to ACC limitations. The set speed is too high and ACC cannot detect other vehicles at far enough distances for the system to operate properly.

**TIGHT CURVE:** This message indicates that ACC has reduced the vehicle speed due to a tight curve in the road. Once the road straightens, ACC will return to the selected set speed or follow distance setting. See "Adaptive Cruise Control (ACC)" under *Turn Signal/Multifunction Lever* on page 3-7 for more information.

You may also see an ACC active symbol, alert symbol or vehicle ahead symbol. See "Adaptive Cruise Control (ACC)" under *Turn Signal/Multifunction Lever* on page 3-7 for more information.

## Accessory Power Outlet(s)

The accessory power outlet can be used to connect electrical equipment, such as a cellular phone.

The accessory power outlet is located inside the center console storage compartment, on the forward left side.

To use the outlet, remove the tethered cap. When not using it, always cover the outlet with the protective cap.

**Notice:** When using an accessory power outlet, maximum electrical load must not exceed 20 amps. Always turn off any electrical equipment when not in use. Leaving electrical equipment on for extended periods will drain your vehicle's battery.

Certain electrical accessories may not be compatible with the accessory power outlet and could result in blown vehicle or adapter fuses. If you experience a problem, see your dealer/retailer for additional information on accessory power outlets.

**Notice:** Adding any electrical equipment to the vehicle can damage it or keep other components from working as they should. The repairs would not be covered by the vehicle warranty. Do not use equipment exceeding maximum amperage rating of 20 amperes. Check with your dealer/retailer before adding electrical equipment.

When adding electrical equipment, be sure to follow the installation instructions included with the equipment.

We recommend that you see a qualified technician or your dealer/retailer for the proper installation of the equipment.

**Notice:** Improper use of the power outlet can cause damage not covered by the warranty. Do not hang any type of accessory or accessory bracket from the plug because the power outlets are designed for accessory power plugs only.

## Ashtray(s) and Cigarette Lighter

The ashtray and cigarette lighter are located under a lid in the front console to the right of the shift lever. Press the left side of the lid and it will open automatically.

To use the cigarette lighter, push it in all the way and let go. When it is ready, it will pop back out by itself.

**Notice:** If papers, pins, or other flammable items are put in the ashtray, hot cigarettes or other smoking materials could ignite them and possibly damage the vehicle. Never put flammable items in the ashtray.

**Notice:** Holding a cigarette lighter in while it is heating does not let the lighter back away from the heating element when it is hot. Damage from overheating can occur to the lighter or heating element, or a fuse could be blown. Do not hold a cigarette lighter in while it is heating.

# Climate Controls

## Dual Climate Control System

With this system the heating, cooling, and ventilation for the vehicle can be controlled.

When the vehicle is first started, the system will recall the last temperature fan and mode settings for that driver.

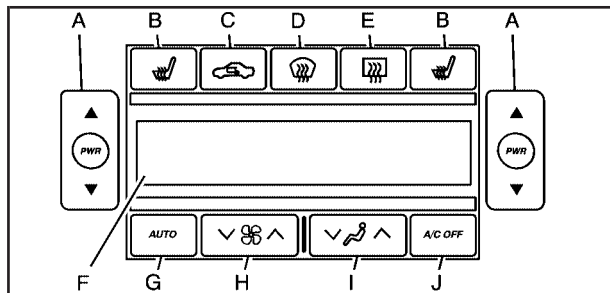

- |   |                              |
|---|------------------------------|
| A. Driver and Passenger Power/Temperature Buttons | F. Display                   |
| B. Heated Seats                                   | G. AUTO                      |
| C. Recirculation                                  | H. Fan Control               |
| D. Defrost  | I. Air Delivery Mode Control |
| E. Rear Window Defogger                           | J. Air Conditioning Off      |

## Automatic Operation

**AUTO (Automatic):** When this button is pressed and the temperature is set, the system automatically controls the temperature, air delivery mode, air conditioning compressor and the fan speed. AUTO will appear on the display.

1. Press the AUTO button.
2. Adjust the temperature to a comfortable setting between 70°F (21°C) and 80°F (27°C). An initial setting of 73°F (23°C) is suggested.

Choosing the warmest or coldest temperature setting will not cause the system to heat or cool any faster. If the system is set at the warmest or coldest temperature setting, the system remains in manual mode at that temperature and it will not go into automatic mode.

In cold weather, the system will start at reduced fan speeds to avoid blowing cold air into your vehicle until warmer air is available. The system starts out blowing air at the floor but may change modes automatically as the vehicle warms up to maintain the chosen temperature setting. The length of time needed for warm up will depend on the outside temperature and the length of time that has elapsed since the vehicle was last driven.





3. Wait for the system to regulate. This may take from 10 to 30 minutes. Then adjust the temperature, if necessary.



You can switch from English to metric units through the Driver Information Center (DIC). See *DIC Operation and Displays on page 3-57* for more information.

The air conditioning system removes moisture from the air, so a small amount of water might drip under the vehicle while idling or after turning off the engine. This is normal.



Do not cover the solar sensor located in the center of the instrument panel, near the windshield. For more information on the solar sensor, see “Sensors” later in this section.

## Manual Operation



 **PWR**  (**Power/Temperature**): Press the PWR button on the left side of the climate control panel to turn the entire climate control system on or off. Press  or  to increase or decrease the temperature inside the vehicle.

Press the PWR button on the right side of the climate control panel to turn the passenger climate control system on or off. Press  or  to increase or decrease the temperature for the passenger.

If the passenger PWR button is off, the driver temperature switch controls the temperature for the entire vehicle.

  **(Fan Control)**: Press to increase or decrease the fan speed. Pressing this switch cancels automatic operation and places the system in manual mode. Press AUTO to return to automatic operation.

If the airflow seems low when the fan speed is at the highest setting, the passenger compartment air filter may need to be replaced. For more information, see *Passenger Compartment Air Filter on page 3-41* and *Scheduled Maintenance on page 7-4*.

  **(Air Delivery Mode Control )**: Press to change the direction of the airflow inside of the vehicle. Changing the mode cancels automatic operation and places the system in manual mode. Press the AUTO button to return to automatic operation.

To change the current mode, select one of the following:

 **(Vent):** Air is directed to the instrument panel outlets.

 **(Bi-Level):** Air is divided between the instrument panel and floor outlets. In automatic operation, cooler air is directed to the upper outlets and warmer air to the floor outlets.

 **(Floor):** Air is directed to the floor outlets, with some air directed to the windshield and side window outlets.

 **(Floor/Defog):** This mode clears windows of fog or moisture. Air is directed to the windshield, floor outlets and side windows. In this mode, the system turns off recirculation and runs the air conditioning compressor unless the outside temperature is near or below freezing.

 **(Defrost):** This mode removes fog or frost from the windshield more quickly. Press to direct air to the windshield, with some air directed to the side windows.

In this mode, the system automatically turns off the recirculation and runs the air conditioning compressor, unless the outside temperature is near or below freezing.

Do not drive the vehicle until all the windows are clear.

**A/C OFF (Air Conditioning):** Press to turn off the air conditioning compressor. Press AUTO to return to automatic operation. The compressor cannot be turned off in either the defrost or floor/defog mode.

 **(Recirculation):** Press to turn the recirculation mode on or off. The air conditioning compressor also comes on.

This mode recirculates and helps to quickly cool the air inside the vehicle. It can be used to help prevent outside air and odors from entering the vehicle. Recirculation is not available in defrost or floor/defog modes.

Using recirculation for long periods of time may cause the air inside the vehicle to become too dry. To prevent this from happening, after the air in the vehicle has cooled, turn the recirculation mode off.



## Rear Window Defogger

The rear window defogger uses a warming grid to remove fog or frost from the rear window.

The rear window defogger only works when the engine is running.

 **(Rear Window Defogger):** Press to turn the rear window defogger on or off. Clear as much snow from the rear window as possible.

The rear window defogger will turn off about 10 minutes after the button is pressed when traveling less than 30 mph (48 km/h). If turned on again, the defogger only runs for about five minutes before turning off. The defogger can also be turned off by turning off the engine.

The heated outside rearview mirrors will heat to help clear fog or frost from the surface of the mirrors when the rear window defogger is on.

The rear window defogger and heated mirrors are automatically disabled when the retractable hardtop is moving or down.

**Notice:** Do not use anything sharp on the inside of the rear window. If you do, you could cut or damage the warming grid, and the repairs would not be covered by the vehicle warranty. Do not attach a temporary vehicle license, tape, a decal or anything similar to the defogger grid.

 **(Heated/Cooled Seat):** Press to turn the feature on. It automatically turns off when the vehicle is turned off. See *Heated and Cooled Seats* on page 1-3 for more information.

## Sensors

There are several sensors on the vehicle that measure the temperature and the sun's effect on passenger comfort.

The solar sensor is located on top of the instrument panel near the windshield. It monitors the solar heat then uses the information to maintain the selected temperature when operating in AUTO mode by initiating needed adjustments to the temperature, the fan speed and the air delivery system. The system may also supply cooler air to the side of the vehicle facing the sun. The recirculation mode will also be activated, as necessary. Do not cover the sensor or the system will not work properly.

There is also a sensor located behind the front bumper. This sensor reads the outside air temperature and helps maintain the temperature inside the vehicle. The outside temperature will be displayed in the navigation system only when the engine is running. Any cover on the front of the vehicle could give a false reading of the temperature.

If the outside temperature goes up, the display temperature will not change until:

- The vehicle's speed is above 15 mph (24 km/h) for five minutes.
- The vehicle's speed is above 32 mph (51 km/h) for two and one-half minutes.

These delays prevent false readings. If the temperature goes down, the outside temperature will be shown when the vehicle is started. If it has been turned off for less than three hours, the temperature will be recalled from the previous vehicle operation.

There is also an inside temperature sensor located to the left of the ignition button. The automatic climate control system uses this sensor to receive information, so if it is blocked or covered, the system will not function properly.

## Outlet Adjustment

Use the thumbwheel to open or close the outlets.

### Operation Tips

- Clear away any ice, snow or leaves from the air inlets at the base of the windshield that may block the flow of air into the vehicle.
- Use of non-GM approved hood deflectors may adversely affect the performance of the system.
- Keep the area around the base of the instrument panel console and air path under the seats clear of objects to help circulate the air inside of the vehicle more effectively.

## Passenger Compartment Air Filter

The passenger compartment air filter removes certain particles from the air, including pollen and dust particles. Reductions in airflow, which may occur more often in dusty areas, indicate that the filter may need to be replaced early.

The filter should be replaced as part of the routine scheduled maintenance. See *Scheduled Maintenance on page 7-4* for more information.

To check or replace the air filter, do the following:

1. With the hood open, unlatch and remove the access panel.

The passenger compartment air filter and access panel are located on the passenger side of the engine compartment near the battery. See *Engine Compartment Overview on page 6-12* for more information on location.

2. Pull the old filter out of the housing.
3. Insert the new filter into the housing.
4. Reinstall the air filter access panel.

## Warning Lights, Gages, and Indicators

Warning lights and gages can signal that something is wrong before it becomes serious enough to cause an expensive repair or replacement. Paying attention to the warning lights and gages could prevent injury.

Warning lights come on when there may be or is a problem with one of the vehicle's functions. Some warning lights come on briefly when the engine is started to indicate they are working.

Gages can indicate when there may be or is a problem with one of the vehicle's functions. Often gages and warning lights work together to indicate a problem with the vehicle.

When one of the warning lights comes on and stays on while driving, or when one of the gages shows there may be a problem, check the section that explains what to do. Follow this manual's advice. Waiting to do repairs can be costly and even dangerous.

## Instrument Panel Cluster

The instrument panel cluster and Driver Information Center (DIC) are designed to show how the vehicle is running. It shows how fast the vehicle is going, about how much fuel is left and many other things needed to drive safely and economically. The instrument panel cluster indicator warning lights, gages and DIC messages are explained on the following pages.

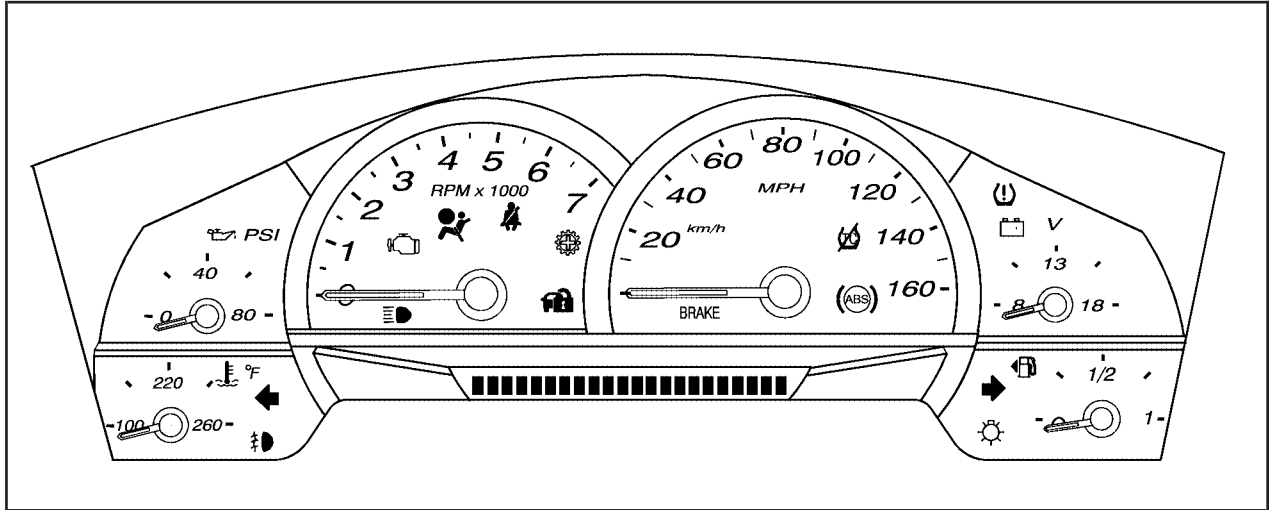

United States Base Cluster shown, Canada and Uplevel similar

## Speedometer and Odometer

The speedometer displays the speed in either miles per hour (mph) or kilometers per hour (km/h).

There is only one scale for mph and km/h. Use the Driver Information Center (DIC) controls to switch between mph and km/h. See *DIC Operation and Displays on page 3-57* for more information. The cluster will calculate the proper speed and move the needle to the correct position. Either the MPH or the km/h telltale will illuminate, depending on which measurement is chosen.

The odometer is part of the Driver Information Center (DIC). See *DIC Operation and Displays on page 3-57* for more information.

## Trip Odometer

The trip odometer is part of the Driver Information Center (DIC). See *DIC Operation and Displays on page 3-57* for more information.

## Tachometer

The tachometer displays the engine speed in thousands of revolutions per minute (rpm).

Fuel will shut off at about 6700 rpm.

If the vehicle is continually driven at the fuel shut off rpm, the engine could be damaged. Be sure to operate the vehicle below the fuel shut off rpm or reduce the rpm quickly when the fuel shuts off.

## Safety Belt Reminders

### Safety Belt Reminder Light

When the engine is started, a chime comes on for several seconds to remind people to fasten their safety belts, unless the driver's safety belt is already buckled.



The safety belt light also comes on and stay on for several seconds, then it flashes for several more.

This chime and light is repeated if the driver remains unbuckled and the vehicle is in motion. If the driver's safety belt is already buckled, neither the chime nor the light comes on.

### Airbag Readiness Light

The system checks the airbag's electrical system for possible malfunctions. If the light stays on it indicates there is an electrical problem. The system check includes the airbag sensor, the pretensioners, the airbag modules, the wiring and the crash sensing and diagnostic module. For more information on the airbag system, see *Airbag System on page 1-38*.

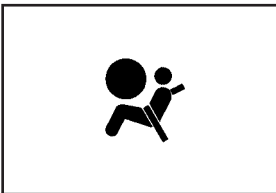

The airbag readiness light flashes for a few seconds when the engine is started. If the light does not come on then, have it fixed immediately.

### CAUTION:

If the airbag readiness light stays on after the vehicle is started or comes on while driving, it means the airbag system might not be working properly. The airbags in the vehicle might not inflate in a crash, or they could even inflate without a crash. To help avoid injury, have the vehicle serviced right away.

If there is a problem with the airbag system, an airbag Driver Information Center (DIC) message can also come on. See *DIC Warnings and Messages on page 3-60* for more information.

## Passenger Airbag Status Indicator

The vehicle has a passenger sensing system. See *Passenger Sensing System* on page 1-45 for important safety information. The rearview mirror has a passenger airbag status indicator.



United States

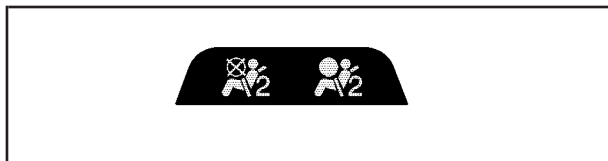

Canada

When the vehicle is started, the passenger airbag status indicator will light ON and OFF, or the symbol for on and off, for several seconds as a system check. Then, after several more seconds, the status indicator will

light either ON or OFF, or either the on or off symbol to let you know the status of the right front passenger frontal and seat-mounted side impact airbags.

If the word ON or the on symbol is lit on the passenger airbag status indicator, it means that the right front passenger frontal airbag and seat-mounted side impact airbag are enabled (may inflate).

If the word OFF or the off symbol is lit on the passenger airbag status indicator, it means that the passenger sensing system has turned off the right front passenger frontal airbag and seat-mounted side impact airbag.

If, after several seconds, both status indicator lights remain on, or if there are no lights at all, there may be a problem with the lights or the passenger sensing system. See your dealer/retailer for service.

### CAUTION:

If the airbag readiness light ever comes on and stays on, it means that something may be wrong with the airbag system. To help avoid injury to yourself or others, have the vehicle serviced right away. See *Airbag Readiness Light* on page 3-44 for more information, including important safety information.

## Charging System Light

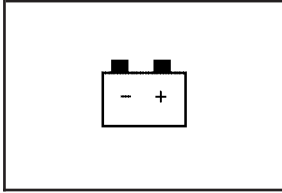

This light comes on briefly when the ignition key is turned to START, but the engine is not running, as a check to show it is working.

If it does not, have the vehicle serviced by your dealer/retailer.

The light should go out once the engine starts. If it stays on, or comes on while driving, there could be a problem with the charging system. A charging system message in the Driver Information Center (DIC) can also appear. See *DIC Warnings and Messages on page 3-60* for more information. This light could indicate that there are problems with a generator drive belt, or that there is an electrical problem. Have it checked right away. If the vehicle must be driven a short distance with the light on, turn off accessories, such as the radio and air conditioner.

## Voltmeter Gage

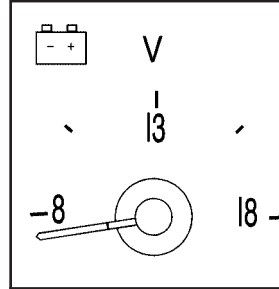

When the vehicle is in accessory mode, the voltmeter shows the voltage output of the battery. When the engine is running, it shows the voltage output of the charging system.

The reading will change as the rate of charge changes (with engine speed, for example), but if the voltmeter reads at 9 volts or below, the instrument panel cluster and other systems may shut down. The Driver Information Center (DIC) will read **LOW VOLTAGE** when the vehicle is at 10 volts or below. Have it checked right away. Driving with the voltmeter reading at 10 volts or below could drain the battery and disable the vehicle.



## Brake System Warning Light

The vehicle's hydraulic brake system is divided into two parts. If one part is not working, the other part can still work and stop the vehicle. For good braking, though, both parts need to be working well.

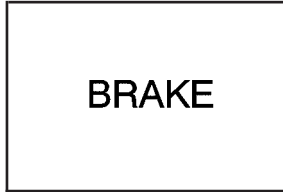

**United States**

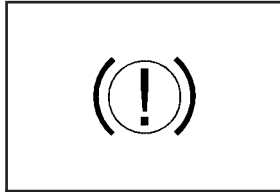

**Canada**

This light should come on when the engine is started. If it does not come on then, have it fixed so it will be ready to warn if there is a problem.

If this warning light stays on after the engine is started, the parking brake may still be set or there could be a brake problem. Refer to *Parking Brake on page 2-32* to see if it is set. If the parking brake is not set, have the brake system inspected right away.

If the light comes on while driving and a LOW BRAKE FLUID message is showing on the DIC, pull off the road and stop carefully. The pedal may be harder to push. Or, the pedal may go closer to the floor and it may take longer to stop. If the light is still on, have the vehicle towed for service. See *Towing Your Vehicle on page 5-26*.

### **CAUTION:**

The brake system might not be working properly if the brake system warning light is on. Driving with the brake system warning light on can lead to a crash. If the light is still on after the vehicle has been pulled off the road and carefully stopped, have the vehicle towed for service.

## Antilock Brake System (ABS) Warning Light

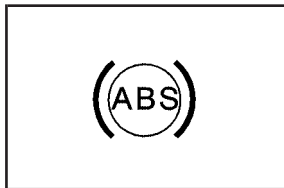

For vehicles with the Antilock Brake System (ABS), this light comes on briefly when the engine is started.

If it does not, have the vehicle serviced by your dealer/retailer. If the system is working normally the indicator light then goes off.

If the ABS light stays on, turn the ignition off. If the light comes on while driving, stop as soon as it is safely possible and turn the ignition off. Then start the engine again to reset the system. If the ABS light stays on, or comes on again while driving, the vehicle needs service. If the regular brake system warning light is not on, the vehicle still has brakes, but not antilock brakes. If the regular brake system warning light is also on, the vehicle does not have antilock brakes and there is a problem with the regular brakes. See *Brake System Warning Light on page 3-47*.

For vehicles with a Driver Information Center (DIC), see *DIC Warnings and Messages on page 3-60* for all brake related DIC messages.

## StabiliTrak<sup>®</sup>/Traction Control System (TCS) Warning Light

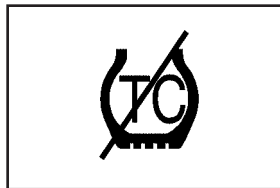

The Traction Control System (TCS)/StabiliTrak system warning light comes on briefly as the engine is started.

If it does not, have the vehicle serviced by your dealer/retailer. If the system is working normally the indicator lights go off.

If the light stays on, or comes on while driving and the DIC shows a SERVICE TRACTION SYS or a SERVICE STABILITRAK message, there is a problem with the Traction Control System (TCS) or the StabiliTrak<sup>®</sup> system and the vehicle needs service.

When the Traction Control system and/or StabiliTrak<sup>®</sup> system are turned off, the light comes on and a chime sounds. The DIC displays either TRACTION SYSTEM OFF or TRAC/STABILITRAK OFF message.

When this light is on, the TCS system does not limit wheel spin and/or the StabiliTrak<sup>®</sup> system does not assist with vehicle control.

When the Traction Control System and/or StabiliTrak<sup>®</sup> system are turned on, the light turns off and a chime sounds. The DIC displays either a TRACTION SYSTEM ON or TRAC/STABILITRAK ON message.

See *Traction Control System (TCS)* on page 5-8, *StabiliTrak<sup>®</sup> System* on page 5-6 and *DIC Warnings and Messages* on page 3-60 for more information.

## Engine Coolant Temperature Gage

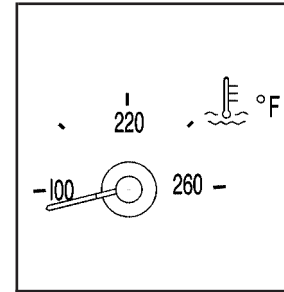

United States

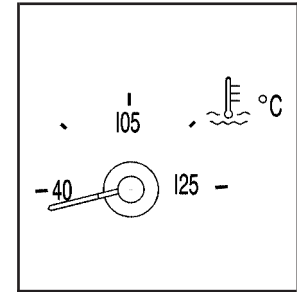

Canada

This gage shows the engine coolant temperature.

As the pointer nears 260°F (125°C), your engine coolant temperature is high. A message may display on the Driver Information Center (DIC) depending on how high the temperature is. See *DIC Warnings and Messages* on page 3-60 for more information.

See *Engine Overheating* on page 6-27 for more information.

## Tire Pressure Light

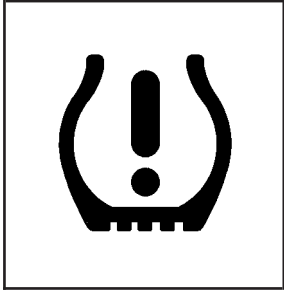

For vehicles with the tire pressure light, it comes on briefly when the engine is started. If it does not, have the vehicle serviced by your dealer/retailer. If the system is working normally the indicator light then goes off.

This light also comes on when one or more of the tires is significantly underinflated.

A tire pressure message in the Driver Information Center (DIC) can accompany the light. See *DIC Warnings and Messages* on page 3-60 for more information.

Stop and check the tires as soon as it is safe to do so. If underinflated, inflate the tire to the proper pressure. See *Tires* on page 6-46 for more information.

If a problem is detected with the Tire Pressure Monitor System, this light flashes for approximately 60 seconds and then stays on for the remainder of the ignition cycle. See *Tire Pressure Monitor System* on page 6-55 for more information.

## Malfunction Indicator Lamp

### Check Engine Light

A computer system called OBD II (On-Board Diagnostics-Second Generation) monitors operation of the fuel, ignition, and emission control systems. It makes sure that emissions are at acceptable levels for the life of the vehicle, helping to produce a cleaner environment.

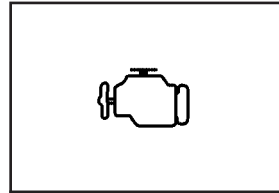

This comes on briefly while starting the engine. If it does not come on, have the vehicle serviced by your dealer/retailer.

If the check engine light comes on and stays on, while the engine is running, this indicates that there is an OBD II problem and service is required.

Malfunctions often are indicated by the system before any problem is apparent. Being aware of the light can prevent more serious damage to the vehicle. This system assists the service technician in correctly diagnosing any malfunction.

**Notice:** If the vehicle is continually driven with this light on, after a while, the emission controls might not work as well, the vehicle's fuel economy might not be as good, and the engine might not run as smoothly. This could lead to costly repairs that might not be covered by the vehicle warranty.

**Notice:** Modifications made to the engine, transmission, exhaust, intake, or fuel system of the vehicle or the replacement of the original tires with other than those of the same Tire Performance Criteria (TPC) can affect the vehicle's emission controls and can cause this light to come on. Modifications to these systems could lead to costly repairs not covered by the vehicle warranty. This could also result in a failure to pass a required Emission Inspection/Maintenance test. See *Accessories and Modifications on page 6-3*.

This light comes on during a malfunction in one of two ways:

**Light Flashing:** A misfire condition has been detected. A misfire increases vehicle emissions and could damage the emission control system on the vehicle. Diagnosis and service might be required.

The following can prevent more serious damage to the vehicle:

- Reduce vehicle speed.
- Avoid hard accelerations.
- Avoid steep uphill grades.

If the light continues to flash, when it is safe to do so, stop the vehicle. Find a safe place to park the vehicle. Turn the key off, wait at least 10 seconds, and restart the engine. If the light is still flashing, follow the previous steps and see your dealer/retailer for service as soon as possible.

**Light On Steady:** An emission control system malfunction has been detected on the vehicle. Diagnosis and service might be required.

An emission system malfunction might be corrected by doing the following:

- Make sure the fuel cap is fully installed. See *Filling the Tank on page 6-8*. The diagnostic system can determine if the fuel cap has been left off or improperly installed. A loose or missing fuel cap allows fuel to evaporate into the atmosphere. A few driving trips with the cap properly installed should turn the light off.
- If the vehicle has been driven through a deep puddle of water, the vehicle's electrical system might be wet. The condition is usually corrected when the electrical system dries out. A few driving trips should turn the light off.

- Make sure to fuel the vehicle with quality fuel. Poor fuel quality causes the engine not to run as efficiently as designed and may cause: stalling after start-up, stalling when the vehicle is changed into gear, misfiring, hesitation on acceleration, or stumbling on acceleration. These conditions might go away once the engine is warmed up.

If one or more of these conditions occurs, change the fuel brand used. It will require at least one full tank of the proper fuel to turn the light off. See *Gasoline Octane on page 6-5*.

If none of the above have made the light turn off, your dealer/retailer can check the vehicle. The dealer/retailer has the proper test equipment and diagnostic tools to fix any mechanical or electrical problems that might have developed.

## Emissions Inspection and Maintenance Programs

Some state/provincial and local governments have or might begin programs to inspect the emission control equipment on the vehicle. Failure to pass this inspection could prevent getting a vehicle registration.

Here are some things to know to help the vehicle pass an inspection:

- The vehicle will not pass this inspection if the check engine light is on with the engine running.

To perform a check engine light bulb check with the keyless ignition, make sure the transmitter fob is in the passenger compartment. See *Ignition Positions on page 2-24*. Press the bottom of the Acc. button on the instrument panel and hold the button down for five seconds. The instrument panel, including the check engine light, will light up and the ignition will be on, but the engine will not start — press the bottom of the Acc. button only briefly, less than five seconds, the accessory power mode will be turned on, but not the ignition. After the bulb check, press and release the Acc. button again to turn the ignition off and avoid draining the vehicle's battery.

- The vehicle will not pass this inspection if the OBD II (on-board diagnostic) system determines that critical emission control systems have not been completely diagnosed by the system. The vehicle would be considered not ready for inspection. This can happen if the battery has recently been replaced or if the battery has run down. The diagnostic system is designed to evaluate critical emission control systems during normal driving. This can take several days of routine driving. If this has been done and the vehicle still does not pass the inspection for lack of OBD II system readiness, your dealer/retailer can prepare the vehicle for inspection.

## Engine Oil Pressure Gage

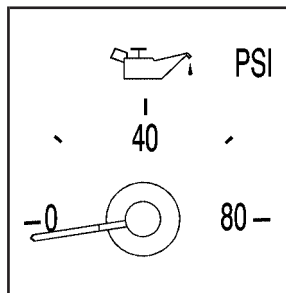

United States

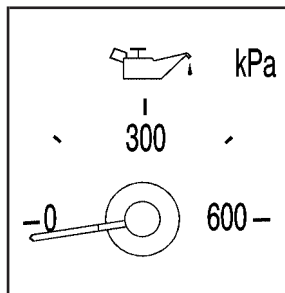

Canada

The engine oil pressure gage shows the engine oil pressure in psi (pounds per square inch) or kPa (kilopascals) when the engine is running.

Oil pressure should be 20 to 80 psi (140 to 550 kPa). In certain situations such as long, extended idles on hot days, it could read as low as 6 psi (40 kPa) and still be considered normal. It may vary with engine speed,

outside temperature and oil viscosity. The Driver Information Center (DIC) may display messages regarding the oil condition. See *DIC Warnings and Messages on page 3-60* and *Engine Oil on page 6-15*.

### CAUTION:

Do not keep driving if the oil pressure is low. The engine can become so hot that it catches fire. Someone could be burned. Check the oil as soon as possible and have the vehicle serviced.

**Notice:** Lack of proper engine oil maintenance can damage the engine. The repairs would not be covered by the vehicle warranty. Always follow the maintenance schedule in this manual for changing engine oil.



## Security Light



For information regarding this light and the vehicle's security system, see *Theft-Deterrent System* on page 2-20.

## Fog Lamp Light

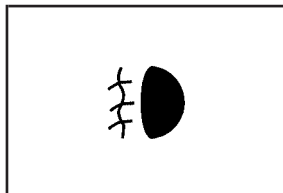

The fog lamp light comes on when the fog lamps are in use.

The light goes out when the fog lamps are turned off. See *Fog Lamps* on page 3-28 for more information.

## Lights On Reminder

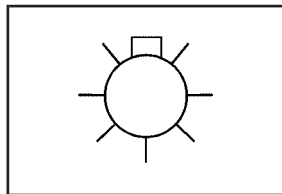

This light comes on whenever the headlamps are on.

**United States Only**

See *Horn* on page 3-6 for more information.

## Highbeam On Light

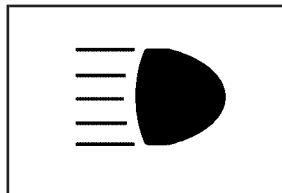

This light comes on when the high-beam headlamps are in use.

See *Headlamp High/Low-Beam Changer* on page 3-8 for more information.

## Fuel Gage

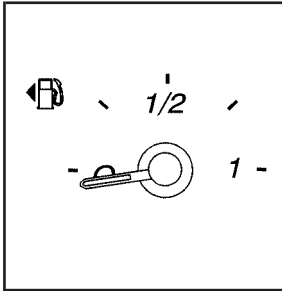

The fuel gage indicates about how much fuel is left when the ignition is turned on.

An arrow on the fuel gage indicates the side of the vehicle the fuel door is on.

When the needle approaches the low fuel symbol, LOW FUEL will appear on the Driver Information Center (DIC) display. At this time, there is still have a little fuel left, but the vehicle's fuel tank should be filled soon.

Press RESET to acknowledge a DIC message(s). Pressing RESET will also turn off a DIC message but the LOW FUEL message will come on again in 10 minutes if fuel has not been added to the vehicle.

Here are five things that some owners ask about. All these things are normal and do not indicate that anything is wrong with the fuel gage.

- At the gas station, the gas pump shuts off before the gage reads the full symbol.
- It takes more (or less) fuel to fill up than the gage reads. For example, the gage reads half full, but it took more (or less) than half of the tank's capacity to fill it.
- The gage pointer may move while cornering, braking or speeding up.
- The gage may not indicate the tank is empty when the ignition is turned off.
- The gage reading may change slightly within the first several minutes after starting the vehicle.

The Driver Information Center (DIC) can be used to show more detailed fuel information. The DIC, can also display:

- **AVERAGE XX.X MPG (Average Miles Per Gallon):** The fuel economy calculated for the last 20 gallons (76 L) of fuel used, or since the display was last reset.
- **INST XX.X MPG (Instantaneous Miles Per Gallon):** The fuel economy calculated for current driving conditions.
- **RANGE XXX MI:** The approximate distance that can be driven before refueling.

See *DIC Operation and Displays* on page 3-57 for more information.

## Driver Information Center (DIC)

This display gives you the status of many of the vehicle's systems. The DIC is also used to display driver personalization features and warning/status messages. All messages will appear in the DIC display, located at the bottom of the instrument panel cluster.

### DIC Operation and Displays

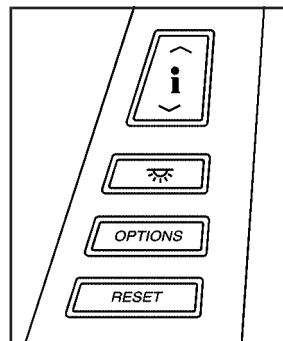

These buttons are located to the right of the steering wheel on the instrument panel, near the air outlets.

**^ i v (Information):** Press to scroll through the available features which include the odometer, trip odometers, fuel range, miles per gallon, average speed, timer, tire pressure, and remaining oil life.

 **(Interior Lamps):** Press to turn the interior lamps on and off.

**OPTIONS:** Press to choose personal options that are available on the vehicle.

**RESET:** Press to reset a feature. It is also used to switch between English and Metric options.

Use the information button to scroll through the following options:

**ODOMETER:** This feature shows how far the vehicle has been driven in either miles (mi) or kilometers (km). Use the ENG/METRIC feature to switch between English and Metric units.

**TRIP A:** This feature will record the distance traveled since the last time it was reset. Press and hold the RESET button to return to zero. If the vehicle is first sold in the United States, the trip odometer will return to zero after 999.9 miles (1 609 km). If the vehicle is first sold in Canada, the trip odometer will return to zero after 1,242 miles (1 999 km).

**TRIP B:** This feature allows you to record the distance traveled during a second trip and functions the same as TRIP A.

**RANGE xxx MI:** This feature shows about how many miles (mi) or kilometers (km) you can drive without refilling the fuel tank. Once the range drops below 40 miles (64 km) remaining, the display will show LOW.

If the vehicle has been idling for a long time, the range displayed on the DIC could be abnormally low. The vehicle must be driven 5-10 miles (8-16 km) to get an accurate reading.

**AVERAGE xx.x MPG (Average Miles Per Gallon):**

This feature shows the approximate fuel economy the vehicle has averaged since the last time the value was reset. To reset the average miles per gallon, press the information button to display AVERAGE xx.x MPG, then press and hold the RESET button until AVERAGE 00.0 MPG is displayed.

**INST xx.x MPG (Instantaneous Miles Per Gallon):**

This feature shows the instantaneous fuel economy which varies with your driving conditions, such as acceleration, braking, and the grade of the road being traveled. The RESET button does not function in this mode.

**AVERAGE SPEED:** This feature shows the average speed the vehicle has traveled since the last time the value was reset. To reset the value, press the information button to display AVERAGE SPEED, then press and hold the RESET button until AVERAGE SPEED 00.0 is displayed.

**ELAPSED TIME:** This feature is like a stopwatch, in that you can clock the time it takes to get from one point to another.

To operate, press the information button to display ELAPSED TIME. Each of the fields for the hours, minutes, and seconds are two numeric digits.

Once ELAPSED TIME 00:00:00 is displayed, press the RESET button to start the timing feature. Press the RESET button again to stop it. If you will be starting and stopping the vehicle, during a trip for instance, the ELAPSED TIME feature will automatically start timing where it left off when you last stopped. To reset it, press and hold the RESET button until the display reads ELAPSED TIME 00:00:00. Press the information button to exit from the ELAPSED TIME display.

**FRONT Lxx Rxx PSI:** This feature shows the tire pressure for the front left and right tires.

**REAR Lxx Rxx PSI:** This feature shows the tire pressure for the rear left and right tires.

**OIL LIFE:** This feature shows the estimated oil life remaining. See *Oil Life Indicator on page 3-76* for more information. To reset the engine oil life system, see *Engine Oil Life System on page 6-18*. This only needs to be reset after you have had the oil changed.

In addition to the engine oil life system monitoring oil life, additional maintenance is recommended in the Maintenance Schedule in this manual. See *Scheduled Maintenance on page 7-4* and *Engine Oil on page 6-15* for more information.

**ENG/METRIC (English/Metric):** This feature allows you to switch the DIC displays between English and Metric. Press the RESET button to switch the display between English and Metric. There will be an arrow next to the option that is selected.

## DIC Warnings and Messages

These messages appear if there is a problem detected in one of the vehicle's systems. You must then press RESET to clear the display screen for further use. However, be sure to take any message that appears on the display screen seriously and remember that pressing the RESET button will only make the message disappear, not the problem.

DIC messages can also be displayed in English, French, German, Italian, Japanese, and Spanish.

### ABS (Antilock Brake System) ACTIVE

This message displays when the Antilock Brake System (ABS) is adjusting brake pressure to help avoid a braking skid.

Slippery road conditions may exist if this message displays, so adjust your driving accordingly. The message may stay on for a few seconds after the system stops adjusting brake pressure.

### BUCKLE PASSENGER

This message reminds you to buckle the passenger safety belt.

This message displays and a chime sounds when the ignition is on, the driver safety belt is buckled, the passenger safety belt is unbuckled with the

passenger airbag enabled, and the vehicle is in motion. You should have the passenger buckle their safety belt.

The reminder will be repeated if the ignition is on, the vehicle is in motion, the driver is buckled and the passenger is still unbuckled, and the passenger airbag is enabled. If the passenger safety belt is already buckled, this message and chime will not come on.

### BUCKLE SEAT BELT

This message reminds you to buckle the driver safety belt.

This message displays and a chime sounds when the ignition is on, the driver safety belt is unbuckled, and the vehicle is in motion. You should buckle the safety belt.

If the driver remains unbuckled when the ignition is on and the vehicle is in motion, the reminder will be repeated. If the driver safety belt is already buckled, this message and chime will not come on.

This message is an additional reminder to the Safety Belt Reminder Light in the instrument panel cluster. See *Safety Belt Reminders on page 3-44* for more information.

## **CHANGE OIL NOW**

This message displays when the life of the engine oil has expired. See *Scheduled Maintenance on page 7-4*. After an oil change, the Oil Life Indicator must be reset. See *Oil Life Indicator on page 3-76* and *Engine Oil Life System on page 6-18*.

## **CHARGE SYSTEM FAULT**

This message displays when a problem with the charging system has been detected. Have the vehicle serviced by your dealer/retailer.

## **CHECK GAS CAP**

This message displays if the fuel cap has not been fully tightened. Check the fuel cap to make sure that it is on properly.

## **CLEAN RADAR CRUISE**

If the vehicle has this feature, this message displays when the Adaptive Cruise Control (ACC) system is disabled because the radar is blocked and cannot detect vehicles in your path. It may also activate during heavy rain or due to road spray. To clean the system, see *Adaptive Cruise Control on page 3-14*.

## **CLOSE CARGO DIVIDER**

This message displays if the cargo divider is not in place. Open the trunk and make sure the cargo divider is secure and no objects are on the divider. See *Rear Storage Area on page 2-54* for more information.

## **COOLANT OVER TEMP (Temperature)**

This message displays when the engine coolant temperature is too hot. Stop and allow the vehicle to idle in P (Park) until it cools down and the message is removed. Do not increase engine speed above a normal idle. If it does not cool down, turn off the engine and have the vehicle serviced by your dealer/retailer before driving it again. Severe engine damage can result from an overheated engine. See *Engine Overheating on page 6-27*.

## **CRUISE NOT READY**

This message indicates that the Adaptive Cruise Control (ACC) will not activate due to a temporary condition. The vehicle does not require service. If this message displays when you attempt to activate the system, continue driving for several minutes, then try to activate the system again.

## **DRIVER NO. X (1 OR 2)**

This message displays when the vehicle is started or when there is a change of driver. The message shows which driver is activating the personalization feature. It will only stay on for five seconds.

## **ENGINE HOT, STOP ENGINE**

This message displays when the engine has overheated. Stop and turn the engine off immediately to avoid severe engine damage. See *Engine Overheating on page 6-27*. A multiple chime also sounds when this message displays.

## **ENGINE PROTECTION REDUCE ENGINE RPM**

If this message displays, the control system has determined that continued operation at the existing engine speed may lead to engine overheating. Lower the engine speed by upshifting the transmission or drive at a lower speed.

## **HEADLAMPS SUGGESTED**

This message displays if it is dark enough outside and the headlamps and Twilight Sentinel® controls are off. This message informs the driver that turning on the

exterior lamps is recommended. It has become dark enough outside to require the headlamps and/or other exterior lamps. This message also displays if the optional Rainsense™ wiping feature is on and the Twilight Sentinel is off.

## **HIGH TRANS (Transmission) TEMP (Temperature)**

This message displays when the transmission fluid in the vehicle is too hot. Stop and allow the vehicle to idle until it cools down or until this message is removed.

## **HIGH VOLTAGE**

This message displays when the electrical charging system is overcharging. To avoid being stranded, have the electrical system checked by your dealer/retailer. You can reduce the charging overload by using the accessories. Turn on the lamps and radio, set the climate control on AUTO and the fan speed on HI, and turn the rear window defogger on. You can monitor battery voltage on the DIC by pressing the information button. The normal range is 11.5 to 15.5 volts when the engine is running.



## **HOT ENGINE–A/C OFF**

This message displays when the engine coolant becomes hotter than the normal operating temperature. You can continue to drive the vehicle. If this message continues to display, have the system repaired by your dealer/retailer as soon as possible to avoid compressor damage.

## **ICE POSSIBLE**

This message displays when the outside air temperature is cold enough to create icy road conditions. Adjust your driving accordingly.

## **LEFT DOOR AJAR**

This message displays anytime the engine is running, the transmission is not in P (Park), and the driver door is open or ajar. A chime sounds when the vehicle's speed is greater than 3 mph (5 km/h).

## **LOW BRAKE FLUID**

This message displays if the engine is running to inform the driver that the brake fluid level is low. Have the brake system serviced by your dealer/retailer as soon as possible. See "Brake Fluid" under *Brakes on page 6-32*.

## **LOW COOLANT**

This message displays when there is a low level of engine coolant. Have the cooling system serviced by your dealer/retailer as soon as possible. See *Engine Coolant on page 6-23*.

## **LOW FUEL**

This message displays when the fuel supply is less than 5 gallons (18.9 L) and the display is turned off. A single chime also sounds when this message is displayed.

## **LOW OIL LEVEL**

For correct operation of the low oil sensing system, the vehicle should be on a level surface. A false LOW OIL LEVEL message may display if the vehicle is parked on a grade. The oil level sensing system does not check for actual oil level if the engine has been off for a short period of time, and the oil level is never checked while the engine is running. If the LOW OIL LEVEL message displays, and the vehicle has been parked on level ground with the engine off for at least 30 minutes, the oil level should be checked by observing the oil dipstick. Prior to checking the oil level, make sure the engine has been off for a few minutes and the vehicle is on a level surface. Then check the dipstick and add oil if necessary. See *Engine Oil on page 6-15*.

## LOW OIL PRESSURE

**Notice:** If you drive your vehicle while the engine oil pressure is low, severe engine damage may occur. If a low oil pressure warning appears on the Driver Information Center (DIC), stop the vehicle as soon as possible. Do not drive the vehicle until the cause of the low oil pressure is corrected.

See *Engine Oil* on page 6-15 for more information.

If this message displays while the engine is running, stop the engine and do not operate the vehicle until the cause of low oil pressure is corrected. Severe damage to the engine can result. A multiple chime sounds when this message is displayed.

## LOW VOLTAGE

This message displays when the electrical system is charging less than 10 volts or if the battery has been drained. If this message displays immediately after starting, it is possible that the generator can still recharge the battery. The battery should recharge while driving, but may take a few hours to do so. Consider using an auxiliary charger to boost the battery after returning home or to a final destination. Make sure you follow the manufacturer's instructions. If this message displays while driving or after starting the vehicle

and stays on, have it checked immediately by your dealer/retailer to determine the cause of this problem. To help the generator recharge the battery quickly, you can reduce the load on the electrical system by turning off the accessories. You can monitor battery voltage on the DIC by pressing the INFO button. The normal range is 11.5 to 15.5 volts.

## LOW WASHER FLUID

This message displays when the windshield washer fluid is low. Fill the windshield washer fluid reservoir as soon as possible. See *Engine Compartment Overview* on page 6-12 for the location of the windshield washer fluid reservoir. Also, see *Windshield Washer Fluid* on page 6-31 for more information.

## MAX (Maximum) SPEED XX MPH (XX KM/H)

This message displays when a failure in the magnetic ride control system has occurred. The Powertrain Control Module (PCM) determines the speed to which the vehicle is limited. Have the vehicle serviced by your dealer/retailer if this message appears.

## NO FOB DETECTED

This message displays if the vehicle does not detect the presence of a keyless access transmitter when you have attempted to start the vehicle or a vehicle door has just closed. The following conditions may cause this message to appear:

- Driver-added equipment plugged into the accessory power outlet on the center console is causing interference. Examples of these devices are cell phones and cell phone chargers, two-way radios, power inverters, or similar items. Try moving the keyless access transmitter away from these devices when starting the vehicle. In addition, PDA devices and remote garage and gate openers may also generate Electromagnetic Interference (EMI) that may interfere with the keyless access transmitter. Do not carry the keyless access transmitter in the same pocket or bag as these devices.
- The vehicle is experiencing Electromagnetic Interference (EMI). Some locations, such as airports, automatic toll booths, and some gas stations, have EMI fields which may interfere with the keyless access transmitter.

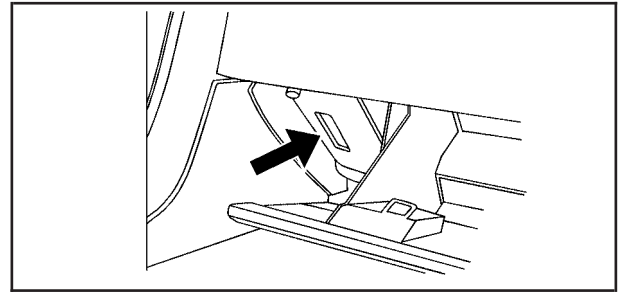

If moving the transmitter to different locations within the vehicle does not help, place the transmitter in the glove box transmitter pocket with the buttons facing to the right and then press the START button.

- The vehicle's battery voltage is low. The battery voltage must be above 10 volts for the keyless access transmitter to be detected properly.

## **NO FOB, OFF OR RUN?**

This message displays when a keyless access transmitter is not detected inside the vehicle while you are trying to turn the ignition off. The vehicle may be near a strong radio antenna signal causing the keyless access system to be jammed. The vehicle will remain in ACCESSORY until the vehicle is turned off or is restarted, or five minutes has expired. If you turn the ignition off and you cannot find the keyless access transmitter, you will not be able to restart the vehicle. The keyless access transmitter needs to be inside of the vehicle in order for the vehicle to start. See *Starting the Engine* on page 2-26 for more information.

## **OVER SPEED WARNING**

This message displays when the vehicle speed exceeds a certain limit as required by some export countries. A chime sounds when this message is displayed.

## **PRESS BRAKE TO START**

This message displays to inform you that the brake pedal must be applied to start the vehicle. Make sure you are pressing the brake pedal all the way down.

## **REDUCED ENGINE POWER**

This message displays when the vehicle is reducing engine power because the transmission is being placed in gear under conditions that may cause damage to the vehicle's engine, transmission, or ability to accelerate. Reduced engine power can affect the vehicle's ability to accelerate. If this message is on, but there is no reduction in performance, proceed to your destination. The performance may be reduced the next time the vehicle is driven. The vehicle may be driven at a reduced speed while this message is on, but acceleration and speed may be reduced. Anytime this message stays on, the vehicle should be taken to your dealer/retailer for service as soon as possible.

## **RIGHT DOOR AJAR**

This message displays anytime the engine is running, the transmission is not in P (Park), and the passenger door is open or ajar. A chime sounds if the vehicle's speed is greater than 3 mph (5 km/h).

## **SERVICE A/C**

This message displays when the electronic sensors that control the air conditioning and heating systems are no longer working. Have the climate control system serviced by your dealer/retailer if you notice a drop in heating and air conditioning efficiency.

## **SERVICE ABS (Antilock Brake System)**

If this message displays when you are driving, stop as soon as possible and turn the ignition off. Then start the engine again to reset the system. If the message stays on, or comes back on again while you are driving, the vehicle is in need of service. See your dealer/retailer.

If the SERVICE ABS message is being displayed, the Traction Control System (TCS) and StabiliTrak<sup>®</sup> System will also be disabled. The Driver Information Center will scroll three messages: SERVICE ABS, SERVICE TRACTION SYS, and SERVICE STABILITRAK, and the antilock brake system and traction control warning lights on the instrument panel cluster will be illuminated. See *Antilock Brake System (ABS) Warning Light on page 3-48* and *StabiliTrak<sup>®</sup>/Traction Control System (TCS) Warning Light on page 3-48*. The driver can acknowledge these messages by pressing the RESET button three times. When the service message is displayed, the computer controlled systems will not assist the driver and you should have the system repaired by your dealer/retailer as soon as possible. Adjust your driving accordingly.

## **SERVICE AFS (Adaptive Forward Lighting System) LAMPS**

This message displays when the Adaptive Forward Lighting System (AFS) is disabled and needs service. See your dealer/retailer. See *Adaptive Forward Lighting System on page 3-28* for more information.

## **SERVICE ELECT (Electrical) SYSTEM**

This message displays if an electrical problem has occurred within the Powertrain Control Module (PCM). Have the vehicle serviced by your dealer/retailer.

## **SERVICE FUEL SYSTEM**

This message displays when the Powertrain Control Module (PCM) has detected a problem within the fuel system. Have the vehicle serviced by your dealer/retailer. This message will also be displayed when the cluster is not getting fuel information from the PCM.

## **SERVICE RADAR CRUISE**

If the vehicle has this feature, this message displays when the Adaptive Cruise Control (ACC) system is disabled and needs service. See your dealer/retailer.

## **SERVICE RIDE CONTROL**

This message displays when there is a problem with the Magnetic Ride Control System. Have the vehicle serviced by your dealer/retailer.

## **SERVICE TRACTION SYS (System)**

This message displays when there is a problem with the Traction Control System (TCS). Have the vehicle serviced by your dealer/retailer.

## **SERVICE STABILITRAK**

If this message displays, it means there may be a problem with the stability enhancement system. If you see this message, try to reset the system. Stop, turn off the engine, then start the engine again. If this message still comes on, it means there is a problem. You should see your dealer/retailer for service. Reduce your speed and drive accordingly. A single chime also sounds when this message is displayed.

## **SERVICE TRANSMISSION**

This message displays when there is a problem with the transmission. Have the vehicle serviced by your dealer/retailer.

## **SERVICE VEHICLE SOON**

This message displays when a non-emissions related powertrain malfunction occurs. Have the vehicle serviced by your dealer/retailer as soon as possible.

## **SHIFT TO PARK**

This message displays if the vehicle is not in P (Park) when the engine is being turned off. The vehicle will be in accessory mode. Once the shift lever is moved to P (Park), the vehicle will turn off.

## **STABILITRAK ACTIVE**

You may see this message on the DIC. It means that an advanced, computer-controlled system has come on to help the vehicle continue to go in the direction in which you are steering. This stability enhancement system activates when the computer senses that the vehicle is just starting to spin, as it might if you hit a patch of ice or other slippery spot on the road. When the system is on, you may hear a noise or feel a vibration in the brake pedal. This is normal.

When this message is on, continue to steer in the direction you want to go. The system is designed to help you in bad weather or other difficult driving situations by making the most of whatever road conditions will permit. If this message comes on, you will know that something has caused the vehicle to start to spin, so consider slowing down. A single chime also sounds when this message is displayed.

## **STABILITRAK READY**

If this message displays and a chime sounds, the system has completed the functional check of the StabiliTrak<sup>®</sup> System.

## **SVC (Service) TIRE MONITOR**

This message displays if a part on the Tire Pressure Monitor System (TPMS) is not working properly. The tire pressure light also flashes and then remains on during the same ignition cycle. See *Tire Pressure Light on page 3-50*. Several conditions may cause this message to appear. See *Tire Pressure Monitor Operation on page 6-57* for more information. If the warning comes on and stays on, there may be a problem with the TPMS. See your dealer/retailer.

## **TOO COLD TO MOVE TOP**

This message displays when the retractable hardtop button is pressed and the hardtop pump motor temperature is below  $-4^{\circ}\text{F}$  ( $-20^{\circ}\text{C}$ ). Wait for the hardtop pump motor to warm up before using the retractable hardtop.

## **TOP INOP (Inoperative) – VALET ON**

This message displays when the retractable hardtop button is pressed and the valet switch is on. Turn off the valet switch before using the retractable hardtop.

## **TOP INOP (Inoperative) OUT OF PARK**

This message displays if the retractable hardtop button is pressed while the vehicle is not in P (Park).

## **TOP MOTOR OVER TEMP (Temperature)**

This message displays when the retractable hardtop button is pressed and the hardtop pump motor temperature is over  $221^{\circ}\text{F}$  ( $105^{\circ}\text{C}$ ). Wait for the hardtop pump motor to cool down before using the retractable hardtop.

## **TOP NOT SECURE**

This message displays when the retractable hardtop button is released before the top open or close operation is complete. Press and hold the retractable hardtop button to fully open or close the top.

## **TRAC (Traction) SYSTEM ACTIVE**

This message displays when the Traction Control System (TCS) is limiting wheel spin. Slippery road conditions may exist if this message is displayed, so adjust your driving accordingly. This message stays on for a few seconds after the TCS stops limited wheel spin.

## TRAC (Traction)/STABILITRAK OFF

This message displays when both the Traction Control System (TCS) and the StabiliTrak<sup>®</sup> System are off. This message will remain until the systems are turned on again.

## TRAC (Traction)/STABILITRAK ON

This message displays when both the Traction Control System (TCS) and the StabiliTrak<sup>®</sup> System are on.

## TRACTION SYSTEM OFF

This message displays when the Traction Control System (TCS) is off, but the StabiliTrak<sup>®</sup> System remains on.

## TRACTION SYSTEM ON

This message displays when the Traction Control System (TCS) is on.

## TRUNK AJAR

This message displays when the trunk is open while the vehicle is running and is not in P (Park).

## Other Messages

Here are more messages that you can receive on the Driver Information Center (DIC). To acknowledge a message and read another message that may have come on at the same time, press the RESET button.

- ACCESSORY MODE ON  
See *Ignition Positions on page 2-24.*
- CHANGE OIL SOON  
See *Engine Oil on page 6-15 and Engine Oil Life System on page 6-18.*
- FOB BATTERY LOW  
See "Battery Replacement" under *Keyless Access System Operation on page 2-5.*
- HIGH TIRE PRESS LF  
See *Inflation - Tire Pressure on page 6-54.*
- HIGH TIRE PRESS RF  
See *Inflation - Tire Pressure on page 6-54.*
- HIGH TIRE PRESS LR  
See *Inflation - Tire Pressure on page 6-54.*
- HIGH TIRE PRESS RR  
See *Inflation - Tire Pressure on page 6-54.*



- INTRUSION SENSOR OFF  
See *Theft-Deterrent System on page 2-20.*
- INTRUSION SENSOR ON  
See *Theft-Deterrent System on page 2-20.*
- KNOWN FOB  
See “Matching Transmitter(s) to Your Vehicle” under *Keyless Access System Operation on page 2-5.*
- LEFT FRONT TIRE FLAT MAX SPD 55, REDUCED HNDLG  
See *Inflation - Tire Pressure on page 6-54.*
- LEFT REAR TIRE FLAT MAX SPD 55, REDUCED HNDLG  
See *Inflation - Tire Pressure on page 6-54.*
- LOW TIRE PRESS LF  
See *Inflation - Tire Pressure on page 6-54.*
- LOW TIRE PRESS RF  
See *Inflation - Tire Pressure on page 6-54.*
- LOW TIRE PRESS LR  
See *Inflation - Tire Pressure on page 6-54.*
- LOW TIRE PRESS RR  
See *Inflation - Tire Pressure on page 6-54.*
- MAX # FOBS LEARNED  
See “Matching Transmitter(s) to Your Vehicle” under *Keyless Access System Operation on page 2-5.*
- OFF-ACC TO LEARN  
See “Matching Transmitter(s) to Your Vehicle” under *Keyless Access System Operation on page 2-5.*
- READY FOR FOB #X  
See “Matching Transmitter(s) to Your Vehicle” under *Keyless Access System Operation on page 2-5.*
- RIGHT FRT TIRE FLAT MAX SPD 55, REDUCED HNDLG  
See *Inflation - Tire Pressure on page 6-54.*
- RIGHT REAR TIRE FLAT MAX SPD 55, REDUCED HNDLG  
See *Inflation - Tire Pressure on page 6-54.*
- WAIT XX MINUTES  
See “Matching Transmitter(s) to Your Vehicle” under *Keyless Access System Operation on page 2-5.*

## DIC Vehicle Personalization

The vehicle has personalization capabilities that allow you to program certain features to a preferred setting for up to two drivers. The back of the keyless access transmitters are labelled 1 or 2.

The current driver preferences are recalled when one of the following occurs:

- The lock or unlock button on the keyless access transmitter, programmed as 1 or 2, is pressed.
- The appropriate memory button, 1 or 2, located on the driver seat is pressed. See *Memory Seat, Mirrors and Steering Wheel* on page 1-3 for more information.
- A valid keyless access transmitter is detected upon opening the driver door.

If more than one valid keyless access transmitter is detected upon opening the driver door, the driver preferences for the lowest driver number will be recalled.

If a keyless access transmitter is programmed as #3 or #4, the personalization system will not recognize the transmitter. The Driver Information Center (DIC) will not display a current driver number and the features that are normally programmed through the DIC will be set to the default states. Also, if the OPTIONS button is pressed, the DIC does not display the menus used to set personalizations, but instead displays OPTIONS UNAVAILABLE for a few seconds.

## Feature Programming

To change feature preferences, make sure the vehicle is running and in P (Park). To avoid excessive drain on the battery, it is recommended that the headlamps are turned off. Press the OPTIONS button and the Driver Information Center (DIC) will display the current driver for a few seconds, then display the first personalization menu item. You can now use the OPTIONS button to change the setting of the displayed feature. Press the top or bottom of the information button to scroll up or down the list of features. When you get to a feature you want to change, press the OPTIONS button again. When you are finished, press the RESET button to exit the personalization menu. If no button is pressed within 45 seconds, the DIC will exit the personalization menu.

The following are DIC options that will be available in the personalization menu.

### Auto Recall

This feature allows the steering column, outside mirrors and the driver seat to automatically move to the current driver's set position when the engine starts. The DIC will display AUTO RECALL OFF or AUTO RECALL ON. Press the OPTIONS button to change the setting.

## Auto Exit Recall

This feature allows the steering column and driver seat to automatically move to the current driver's exit position when one of the following occurs:

- The vehicle is turned off or in RAP or accessory mode and the driver's door is opened.
- The vehicle is turned off or in RAP and the unlock button on the keyless access transmitter is pressed.

The DIC will display AUTO EXIT RECALL OFF or AUTO EXIT RECALL ON. Press the OPTIONS button to change the setting.

## Approach Lights

This feature activates the parking lamps, front fog lamps and back-up lamps during low light periods when the unlock button on the keyless access transmitter is pressed, both doors are closed and the vehicle is off or in RAP. The lamps remain on for 20 seconds or until a door is opened, the lock button on the keyless access transmitter is pressed or the vehicle is no longer off or in RAP.

The DIC will display APPROACH LIGHTS OFF or APPROACH LIGHTS ON. Press the OPTIONS button to change the setting.

## Exit Lights

This feature activates the parking lamps and front fog lamps for 15, 30 or 90 seconds. This will occur when the vehicle is off or in RAP and the headlamps are on due to the automatic headlamp system. The parking lamps and front fog lamps will remain on until the driver selected time period expires, the exterior lamp control is activated or the vehicle is no longer off or in RAP.

The DIC will display EXIT LIGHTS OFF, EXIT LIGHTS - 15 SEC, EXIT LIGHTS - 30 SEC, or EXIT LIGHTS - 90 SEC. Press the OPTIONS button to change the setting.

## Flash at Unlock

This feature activates the front and rear turn signals for two short flashes when the unlock or trunk button on the keyless access transmitter is pressed. This will only occur when the vehicle is off.

The DIC will display NO FLASH AT UNLOCK or FLASH AT UNLOCK. Press the OPTIONS button to change the setting.

## Flash at Lock

This feature activates the front and rear turn signals for one long flash when the lock button on the keyless access transmitter is pressed. This will only occur when the vehicle is off. If the lock button is pressed again within five seconds, the horn will sound regardless of which setting you have selected.

The DIC will display NO FLASH AT LOCK or FLASH AT LOCK. Press the OPTIONS button to change the setting.

## FOB Reminder

This feature sounds the horn three times when the driver door is closed and there is a keyless access transmitter inside the interior of the vehicle. This will only occur when the vehicle is off.

The DIC will display FOB REMINDER OFF or FOB REMINDER HORN. Press the OPTIONS button to change the setting.

## Passive Locking

This feature allows you to select whether the doors automatically lock during normal vehicle exit. When the ignition is turned off and all doors become closed, the vehicle will determine how many keyless access transmitters remain in the vehicle interior. If at least

one keyless access transmitter has been removed from the interior of the vehicle, the doors will lock after eight seconds.

For example, if there are two keyless access transmitters in the vehicle and one is removed, the other will be locked in. The keyless access transmitter locked in the vehicle can still be used to start the vehicle or unlock the doors, if needed. A person approaching the outside of the locked vehicle without an authorized keyless access transmitter, however, will not be able to open the door, even with a transmitter in the vehicle.

You may temporarily disable the passive door locking feature by pressing the door unlock switch for three seconds on an open door. Passive door locking will then remain disabled until a door lock switch is pressed or until the power mode transitions from the off power mode.

You can select to not have the horn sound when the passive lock occurs. If you choose this setting, the doors will automatically lock eight seconds after you turn the ignition off, remove a keyless access transmitter from the interior of the vehicle, and close both doors.

You can also select to have the horn sound once when the passive lock occurs. If you choose this setting, the doors will automatically lock and the horn will chirp eight seconds after you turn the ignition off, remove a keyless access transmitter from the interior of the vehicle, and close both doors.

If you are parking in a quiet area and do not want the horn to sound when the doors lock, press the lock button on the keyless access transmitter immediately after removing it from the interior and closing the doors. This will lock the doors and cancel the passive locking for this ignition cycle.

The DIC will display **PASSIVE LOCKING OFF**, **SILENT PASSIVE LOCK**, or **HORN AT PASSIVE LOCK**. Press the **OPTIONS** button to change the setting.

## Passive Unlocking

This feature allows you to select which doors will automatically unlock when you approach and open the driver door with the keyless access transmitter. You can choose to have the driver door unlock or both doors unlock. See *Door Locks on page 2-10* for more information.

The DIC will display **PASSIVE UNLK DRIVER** or **PASSIVE UNLK BOTH**. Press the **OPTIONS** button to change this setting.

## Auto Unlock

This feature automatically unlocks either the driver door or both doors, depending on the setting, when the shift lever is moved to P (Park).

The DIC will display **AUTO UNLOCK OFF**, **AUTO UNLOCK DRIVER**, or **AUTO UNLOCK BOTH**. Press the **OPTIONS** button to change the setting.

## Park Assist

This feature tilts the passenger side mirror downward when the shift lever is moved to R (Reverse). This can help you to see the curb while backing up. If you adjust the mirror while in R (Reverse), the new position will be saved as the park assist position.

The DIC will display **PARK ASSIST OFF** or **PARK ASSIST ON**.

## Language

This feature allows you to select the language the DIC and Head-Up Display (HUD), uses to display messages.

The DIC will display **ENGLISH**, **FRENCH**, **GERMAN**, **ITALIAN**, **JAPANESE**, or **SPANISH**. Press the **OPTIONS** button to change the setting.

If you become stuck in a language that you do not understand, hold the **OPTIONS** and **RESET** buttons for five seconds. The DIC will scroll through all available languages for as long as the buttons are held. Each language option will display in its own language. For example, English will be displayed as **ENGLISH**, Spanish as **ESPAÑOL**, etc. When the desired language is available, release the buttons and the DIC will set to this language.

## Trip Computer

### Oil Life Indicator

This feature lets you know when to change the engine oil. It is based on the engine oil temperatures and your driving patterns.

To see the display, press the information button several times until OIL LIFE appears. If you see 99% OIL LIFE, 99 percent of the current oil life remains.

The DIC may display a CHANGE OIL NOW message. If you see CHANGE OIL NOW, it means the oil life is gone. For more information, see *Scheduled Maintenance on page 7-4* and *Engine Oil on page 6-15*.

When the oil is changed, you will need to reset the system. See *Engine Oil Life System on page 6-18*. Always keep a written record of the mileage and date when you changed your oil.

## Audio System(s)

Read the following pages to become familiar with the audio system's features.

### CAUTION:

Taking your eyes off the road for extended periods could cause a crash resulting in injury or death to you or others. Do not give extended attention to entertainment tasks while driving.

This system provides access to many audio and non audio listings.

To minimize taking your eyes off the road while driving, do the following while the vehicle is parked:

- Become familiar with the operation and controls of the audio system.
- Set up the tone, speaker adjustments, and preset radio stations.

For more information, see *Defensive Driving on page 5-2*.

**Notice:** Contact your dealer/retailer before adding any equipment.

**Adding audio or communication equipment could interfere with the operation of the vehicle's engine, radio, or other systems, and could damage them. Follow federal rules covering mobile radio and telephone equipment.**

The vehicle has Retained Accessory Power (RAP). With RAP, the audio system can be played even after the ignition is turned off. See *Retained Accessory Power (RAP)* on page 2-25 for more information.

## Bluetooth®

Vehicles with a Bluetooth system can use a Bluetooth capable cell phone with a Hands Free Profile to make and receive phone calls. The system can be used while the key is in ON/RUN or ACC/ACCESSORY position. The range of the Bluetooth system can be up to 30 ft. (9.1 m). Not all phones support all functions, and not all phones are guaranteed to work with the in-vehicle Bluetooth system. See [gm.com/bluetooth](http://gm.com/bluetooth) for more information on compatible phones.

## Voice Recognition

The Bluetooth system uses voice recognition to interpret voice commands to dial phone numbers and name tags.

**Noise:** Keep interior noise levels to a minimum. The system may not recognize voice commands if there is too much background noise.

**When to Speak:** A short tone sounds after the system responds indicating when it is waiting for a voice command. Wait until the tone and then speak.

**How to Speak:** Speak clearly in a calm and natural voice.

## Audio System

When using the in-vehicle Bluetooth system, sound comes through the vehicle's front audio system speakers and over-rides the audio system. Use the audio system volume knob, during a call, to change the volume level. The adjusted volume level remains in memory for later calls. To prevent missed calls, a minimum volume level is used if the volume is turned down too low.

## Bluetooth Controls

Use the buttons located on the steering wheel to operate the in-vehicle Bluetooth system. See *Audio Steering Wheel Controls on page 3-88* for more information.

 **(Push To Talk):** Press to answer incoming calls, to confirm system information, and to start speech recognition.

 **(Phone On Hook):** Press to end a call, reject a call, or to cancel an operation.

## Pairing

A Bluetooth enabled cell phone must be paired to the in-vehicle Bluetooth system first and then connected to the vehicle before it can be used. See the cell phone manufacturers user guide for Bluetooth functions before pairing the cell phone. If a Bluetooth phone is not connected, calls will be made using OnStar® Hands-Free Calling, if available. Refer to the OnStar owner's guide for more information.



### Pairing Information:

- Up to five cell phones can be paired to the in-vehicle Bluetooth system.
- The pairing process is disabled when the vehicle is moving.
- The in-vehicle Bluetooth system automatically links with the first available paired cell phone in the order the phone was paired.
- Only one paired cell phone can be connected to the in-vehicle Bluetooth system at a time.
- Pairing should only need to be completed once, unless changes to the pairing information have been made or the phone is deleted.

To link to a different paired phone, see *Linking to a Different Phone* later in this section.





## Pairing a Phone

1. Press and hold   for two seconds. The system responds with “Ready” followed by a tone.
2. Say “Bluetooth”. The system responds with “Bluetooth ready” followed by a tone.
3. Say “Pair”. The system responds with instructions and a four digit PIN number. The PIN number will be used in Step 4.
4. Start the Pairing process on the cell phone that will be paired to the vehicle. Reference the cell phone manufacturers user guide for information on this process.



Locate the device named “General Motors” in the list on the cellular phone and follow the instructions on the cell phone to enter the four digit PIN number that was provided in Step 3.

5. The system prompts for a name for the phone. Use a name that best describes the phone. This name will be used to indicate which phone is connected. The system then confirms the name provided.
6. The system responds with “<Phone name> has been successfully paired” after the pairing process is complete.
7. Repeat Steps 1 through 7 for additional phones to be paired.



## Listing All Paired and Connected Phones

1. Press and hold   for two seconds. The system responds with “Ready” followed by a tone.
2. Say “Bluetooth”. The system responds with “Bluetooth ready” followed by a tone.
3. Say “List”. The system lists all the paired Bluetooth devices. If a phone is connected to the vehicle, the system will say “Is connected” after the connected phone.

## Deleting a Paired Phone

1. Press and hold   for two seconds. The system responds with “Ready” followed by a tone.
2. Say “Bluetooth”. The system responds with “Bluetooth ready” followed by a tone.
3. Say “Delete”. The system asks which phone to delete followed by a tone.
4. Say the name of the phone to be deleted. If the phone name is unknown, use the “List” command for a list of all paired phones. The system responds with “Would you like to delete <phone name>? Yes or No” followed by a tone
5. Say “Yes” to delete the phone. The system responds with “OK, deleting <phone name>”.

## Linking to a Different Phone

1. Press and hold   for two seconds. The system responds with “Ready” followed by a tone.
2. Say “Bluetooth”. The system responds with “Bluetooth ready” followed by a tone.
3. Say “Change phone”. The system responds with “Please wait while I search for other phones”.
  - If another phone is found, the response will be “<Phone name> is now connected”.
  - If another phone is not found, the original phone remains connected.

## Storing Name Tags



The system can store up to thirty phone numbers as name tags that are shared between the Bluetooth and OnStar systems.

The system uses the following commands to store and retrieve phone numbers:

- Store
- Digit Store
- Directory

## Using the Store Command



The store command allows a phone number to be stored without entering the digits individually.

1. Press and hold   for two seconds. The system responds with “Ready” followed by a tone.
2. Say “Store”. The system responds with “Store, number please” followed by a tone.
3. Say the complete phone number to be stored at once with no pauses.
  - If the system recognizes the number it responds with “OK, Storing” and repeats the phone number.
  - If the system is unsure it recognizes the phone number, it responds with “Store” and repeats the number followed by “Please say yes or no”. If the number is correct, say “Yes”. If the number is not correct, say “No”. The system will ask for the number to be re-entered.
4. After the system stores the phone number, it responds with “Please say the name tag” followed by a tone.

5. Say a name tag for the phone number. The name tag is recorded and the system responds with "About to store <name tag>. Does that sound OK?".
  - If the name tag does not sound correct, say "No" and repeat Step 5.
  - If the name tag sounds correct, say "Yes" and the name tag is stored. After the number is stored the system returns to the main menu.

## Using the Digit Store Command



The digit store command allows a phone number to be stored by entering the digits individually.

1. Press and hold   for two seconds. The system responds with "Ready" followed by a tone.
2. Say "Digit Store". The system responds with "Please say the first digit to store" followed by a tone.
3. Say the first digit to be stored. The system will repeat back the digit it heard followed by a tone. Continue entering digits until the number to be stored is complete.
  - If an unwanted number is recognized by the system, say "Clear" at any time to clear the last number.
  - To hear all of the numbers recognized by the system, say "Verify" at any time and the system will repeat them.

4. After the complete number has been entered, say "Store". The system responds with "Please say the name tag" followed by a tone.
5. Say a name tag for the phone number. The name tag is recorded and the system responds with "About to store <name tag>. Does that sound OK?".
  - If the name tag does not sound correct, say "No" and repeat Step 5.
  - If the name tag sounds correct, say "Yes" and the name tag is stored. After the number is stored the system returns to the main menu.

## Using the Directory Command

The directory command lists all of the name tags stored by the system. To use the directory command:

1. Press and hold   for two seconds. The system responds with "Ready" followed by a tone.
2. Say "Directory". The system responds with "Directory" and then plays back all of the stored name tags. When the list is complete, the system returns to the main menu.

## Deleting Name Tags



The system uses the following commands to delete name tags:

- Delete
- Delete all name tags

## Using the Delete Command

The delete command allows specific name tags to be deleted.



To use the delete command:

1. Press and hold   for two seconds. The system responds with “Ready” followed by a tone.
2. Say “Delete”. The system responds with “Delete, please say the name tag” followed by a tone.
3. Say the name tag to be deleted. The system responds with “Would you like to delete, <name tag>? Please say yes or no”.
  - If the name tag is correct, say “Yes” to delete the name tag. The system responds with “OK, deleting <name tag>, returning to the main menu.”
  - If the name tag is incorrect, say “No”. The system responds with “No. OK, let’s try again, please say the name tag.”

## Using the Delete All Name Tags Command

The delete all name tags command deletes all stored phone book name tags and route name tags for OnStar (if present).

To use the delete all name tags command:



1. Press and hold   for two seconds. The system responds with “Ready” followed by a tone.
2. Say “Delete all name tags”. The system responds with “You are about to delete all name tags stored in your phone directory and your route destination directory. Are you sure you want to do this? Please say yes or no.”
  - Say “Yes” to delete all name tags.
  - Say “No” to cancel the function and return to the main menu.

## Making a Call



Calls can be made using the following commands:

- Dial
- Digit Dial
- Call
- Re-dial



## Using the Dial Command

1. Press and hold   for two seconds. The system responds with “Ready” followed by a tone.
2. Say “Dial”. The system responds with “Dial using <phone name>.” “Number please” followed by a tone.
3. Say the entire number without pausing.
  - If the system recognizes the number, it responds with “OK, Dialing” and dials the number.
  - If the system does not recognize the number, it confirms the numbers followed by a tone. If the number is correct, say “Yes”. The system responds with “OK, Dialing” and dials the number. If the number is not correct, say “No”. The system will ask for the number to be re-entered.

## Using the Digit Dial Command



1. Press and hold   for two seconds. The system responds with “Ready” followed by a tone.
2. Say “Digit Dial”. The system responds with “Digit dial using <phone name>, please say the first digit to dial” followed by a tone.
3. Say the digit to be dialed one at a time. Following each digit, the system will repeat back the digit it heard followed by a tone.
4. Continue entering digits until the number to be dialed is complete. After the whole number has been entered, say “Dial”. The system responds with “OK, Dialing” and dials the number.
  - If an unwanted number is recognized by the system, say “Clear” at any time to clear the last number.
  - To hear all of the numbers recognized by the system, say “Verify” at any time and the system will repeat them.

## Using the Call Command

1. Press and hold   for two seconds. The system responds with “Ready” followed by a tone.
2. Say “Call”. The system responds with “Call using <phone name>”. Please say the name tag followed by a tone.
3. Say the name tag of the person to call.
  - If the system clearly recognizes the name tag it responds with “OK, calling, <name tag>” and dials the number.
  - If the system is unsure it recognizes the right name tag, it confirms the name tag followed by a tone. If the name tag is correct, say “Yes”. The system responds with “OK, calling, <name tag>” and dials the number. If the name tag is not correct, say “No”. The system will ask for the name tag to be re-entered.

Once connected, the person called will be heard through the audio speakers.





## Using the Re-dial Command

1. Press and hold   for two seconds. The system responds with “Ready” followed by a tone.
2. After the tone, say “Re-dial”. The system responds with “Re-dial using <phone name>” and dials the last number called from the connected Bluetooth phone.

Once connected, the person called will be heard through the audio speakers.





## Receiving a Call



When an incoming call is received, the audio system mutes and a ring tone is heard in the vehicle.

- Press   and begin speaking to answer the call.
- Press   to ignore a call.

## Call Waiting





Call waiting must be supported on the Bluetooth phone and enabled by the wireless service carrier to work.

- Press   to answer an incoming call when another call is active. The original call is placed on hold.
- Press   again to return to the original call.

- To ignore the incoming call, continue with the original call with no action.
- Press   to disconnect the current call and switch to the call on hold.

## Three-Way Calling

Three-Way Calling must be supported on the Bluetooth phone and enabled by the wireless service carrier to work.

1. While on a call press  . The system responds with “Ready” followed by a tone.
2. Say “Three-way call”. The system responds with “Three-way call, please say dial or call”.
3. Use the dial or call command to dial the number of the third party to be called.
4. Once the call is connected, press   to link all the callers together.



## Ending a Call

Press   to end a call.



## Muting a Call

During a call, all sounds from inside the vehicle can be muted so that the person on the other end of the call cannot hear them.

### To Mute a call

1. Press  . The system responds with “Ready” followed by a tone.
2. Say “Mute Call”. The system responds with “Call muted”.

### To Cancel Mute



1. Press  . The system responds with “Ready” followed by a tone.
2. After the tone, say “Mute Call”. The system responds with “Resuming call”.

## Transferring a Call

Audio can be transferred between the in-vehicle Bluetooth system and the cell phone.



### To Transfer Audio to the Cell Phone

During a call with the audio in the vehicle:

1. Press  . The system responds with “Ready” followed by a tone.
2. Say “Transfer Call.” The system responds with “Transferring call” and the audio will switch from the vehicle to the cell phone.



### To Transfer Audio to the In-Vehicle Bluetooth System

The cellular phone must be paired and connected with the Bluetooth system before a call can be transferred. The connection process can take up to two minutes after the key is turned to the ON/RUN or ACC/ACCESSORY position.

During a call with the audio on the cell phone, press   for more than two seconds. The audio switches from the cell phone to the vehicle.

## Voice Pass-Thru

Voice Pass-Thru allows access to the voice recognition commands on the cell phone. See the cell phone manufacturers user guide to see if the cell phone supports this feature. This feature can be used to verbally access contacts stored in the cell phone.



1. Press and hold   for two seconds. The system responds with “Ready” followed by a tone.
2. Say “Bluetooth”. The system responds with “Bluetooth ready” followed by a tone.
3. Say “Voice”. The system responds with “OK, accessing <phone name>”.
  - The cell phone’s normal prompt messages will go through its cycle according to the phone’s operating instructions.





## Dual Tone Multi-Frequency (DTMF) Tones

The in-vehicle Bluetooth system can send numbers and numbers stored as name tags during a call. This is used when calling a menu driven phone system. Account numbers can be programmed into the phonebook for retrieval during menu driven calls.

### Sending a number during a call

1. Press   . The system responds with “Ready” followed by a tone.
2. Say “Dial”. The system responds with “Say a number to send tones” followed by a tone.
3. Say the number to send.
  - If the system clearly recognizes the number it responds with “OK, Sending Number” and the dial tones are sent and the call continues.
  - If the system is not sure it recognized the number properly, it responds “Dial Number, Please say yes or no?” followed by a tone. If the number is correct, say “Yes”. The system responds with “OK, Sending Number” and the dial tones are sent and the call continues.

### Sending a Stored Name Tag During a Call

1. Press   . The system responds with “Ready” followed by a tone.
2. Say “Send name tag.” The system responds with “Say a name tag to send tones” followed by a tone.
3. Say the name tag to send.
  - If the system clearly recognizes the name tag it responds with “OK, Sending <name tag>” and the dial tones are sent and the call continues.
  - If the system is not sure it recognized the name tag properly, it responds “Dial <name tag>, Please say yes or no?” followed by a tone. If the name tag is correct, say “Yes”. The system responds with “OK, Sending <name tag>” and the dial tones are sent and the call continues.

### Clearing the System

Unless information is deleted out of the in-vehicle Bluetooth system, it will be retained indefinitely. This includes all saved name tags in the phonebook and phone pairing information. For information on how to delete this information, see the above sections on Deleting a Paired Phone and Deleting Name Tags.

## Other Information

The Bluetooth® word mark and logos are owned by the Bluetooth® SIG, Inc. and any use of such marks by General Motors is under license. Other trademarks and trade names are those of their respective owners.

This device complies with Part 15 of the FCC Rules. Operation is subject to the following two conditions:

1. This device may not cause harmful interference.
2. This device must accept any interference received, including interference that may cause undesired operation.

This device complies with RSS-210 of Industry Canada. Operation is subject to the following two conditions:

1. This device may not cause interference.
2. This device must accept any interference received, including interference that may cause undesired operation of the device.

Changes or modifications to this system by other than an authorized service facility could void authorization to use this equipment.

## Theft-Deterrent Feature

THEFTLOCK® is designed to discourage theft of the vehicle's radio by learning a portion of the Vehicle Identification Number (VIN). The radio does not operate if it is stolen or moved to a different vehicle.

## Audio Steering Wheel Controls

The vehicle has audio steering wheel controls. These controls may differ depending on the vehicle's options.

On the left side, the vehicle may have:

- SEEK, SRCE, Heated Steering Wheel and Cruise Control Cancel.
- SRCE, Heated Steering Wheel, Adaptive Cruise Control Gap, and Cruise Control Cancel.

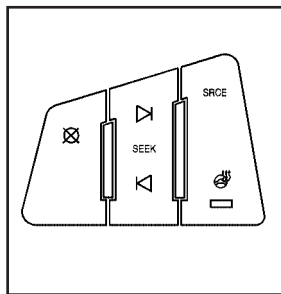

**Audio Controls With  
Heated Steering Wheel  
and Cruise Control  
Cancel**

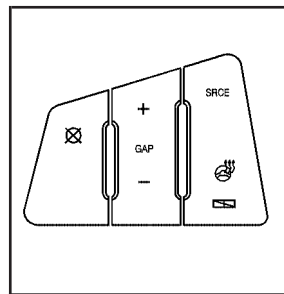

**Audio Controls With  
Heated Steering Wheel  
and Adaptive Cruise  
and GAP**

The right side controls are the same for all vehicles.

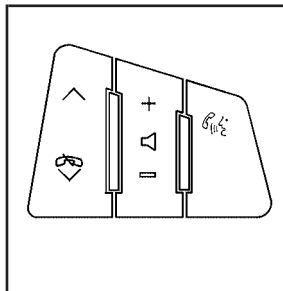

### Right-Side Audio Controls

Some audio controls can be adjusted at the steering wheel. See the following descriptions of the controls that can be adjusted.

**◀ SEEK ▶** : Press to go to the previous or the next radio station.

The radio seeks stations only with a strong signal that are in the selected band.

Press either SEEK arrow to go to the previous or the next track while listening to a CD.

**SRCE (Source)**: Press to switch between the radio (AM, FM), XM and CD.

**SCAN**: To scan stations, press and hold this button for a few seconds, the radio goes to a station, plays for a few seconds, then goes to the next station. Press this button again to stop scanning.

The radio scans stations only with a strong signal that are in the selected band.

**^ v (Previous/Next)**: Press to go to the previous or the next radio station stored as a favorite.

When a CD is playing, press either arrow to go to the previous or to the next track.

**📞 v (Phone On Hook)**: Press to end a call, reject a call, or to cancel an operation.

**+ - (Volume)**: Press to increase or to decrease the radio volume.

**🗣️ (Voice Recognition)**: Press and release to initiate voice recognition for the Navigation System. See *Voice Recognition on page 4-74* for more information.

Press and hold **🗣️** for longer than two seconds to interact with the OnStar<sup>®</sup> or Bluetooth<sup>®</sup> systems. See *OnStar<sup>®</sup> System on page 2-42* or *Bluetooth<sup>®</sup> on page 3-77* for more information about these features.

## Radio Reception

Frequency interference and static can occur during normal radio reception if items such as cell phone chargers, vehicle convenience accessories, and external electronic devices are plugged into the accessory power outlet. If there is interference or static, unplug the item from the accessory power outlet.

### AM

The range for most AM stations is greater than for FM, especially at night. The longer range can cause station frequencies to interfere with each other. For better radio reception, most AM radio stations boost the power levels during the day, and then reduce these levels during the night. Static can also occur when things like storms and power lines interfere with radio reception. When this happens, try reducing the treble on the radio.

### FM Stereo

FM signals only reach about 10 to 40 miles (16 to 65 km). Although the radio has a built-in electronic circuit that automatically works to reduce interference, some static can occur, especially around tall buildings or hills, causing the sound to fade in and out.

## XM Satellite Radio Service

XM Satellite Radio Service gives digital radio reception from coast-to-coast in the 48 contiguous United States, and in Canada. Just as with FM, tall buildings or hills can interfere with satellite radio signals, causing the sound to fade in and out. In addition, traveling or standing under heavy foliage, bridges, garages, or tunnels may cause loss of the XM signal for a period of time.

### Cellular Phone Usage

Cellular phone usage may cause interference with the vehicle's radio. This interference may occur when making or receiving phone calls, charging the phone's battery, or simply having the phone on. This interference causes an increased level of static while listening to the radio. If static is received while listening to the radio, unplug the cellular phone and turn it off.

## Care of Your CDs

Handle CDs carefully. Store them in their original cases or other protective cases and away from direct sunlight and dust. The CD player scans the bottom surface of the disc. If the surface of a CD is damaged, such as cracked, broken, or scratched, the CD does not play properly or not at all. If the surface of a CD is soiled, take a soft, lint free cloth or dampen a clean, soft cloth in a mild, neutral detergent solution mixed with water, and clean it. Make sure the wiping process starts from the center to the edge.

Do not touch the bottom side of a CD while handling it; this could damage the surface. Pick up CDs by grasping the outer edges or the edge of the hole and the outer edge.

## Care of the CD Player

Do not use CD lens cleaners for CD players because the lens of the CD optics can become contaminated by lubricants.

## Diversity Antenna System

The AM-FM antenna is a hidden self tuning system. It optimizes the AM and FM signals relative to the vehicle's position and radio station source. No maintenance or adjustments are needed.

## XM™ Satellite Radio Antenna System

The vehicle may have the XM™ Satellite Radio antennas that are located in the outside rear view mirrors. These antennas are hidden from view and are not accessible.



# Section 4 Navigation System

---

<b>Overview</b> .....	4-2	Keyless Access System .....	4-48
Navigation System Overview .....	4-2	OnStar® System .....	4-48
Getting Started .....	4-4	Global Positioning System (GPS) .....	4-49
<b>Features and Controls</b> .....	4-10	Vehicle Positioning .....	4-50
Using the Navigation System .....	4-10	Problems with Route Guidance .....	4-51
Setup Menu .....	4-12	If the System Needs Service .....	4-51
Plan Route .....	4-18	Ordering Map DVDs .....	4-52
Edit Memory Point .....	4-19	Database Coverage Explanations .....	4-52
Edit Waypoint .....	4-23	<b>Navigation Audio System</b> .....	4-52
Edit Avoid Point/Area .....	4-25	Six-Disc CD Changer .....	4-65
Enter Destination .....	4-27	CD/DVD Player .....	4-68
Route Preference .....	4-36	Radio Personalization with Home and Away Feature .....	4-73
Maps .....	4-38	<b>Voice Recognition</b> .....	4-74
Symbols .....	4-43		

# Overview

## Navigation System Overview

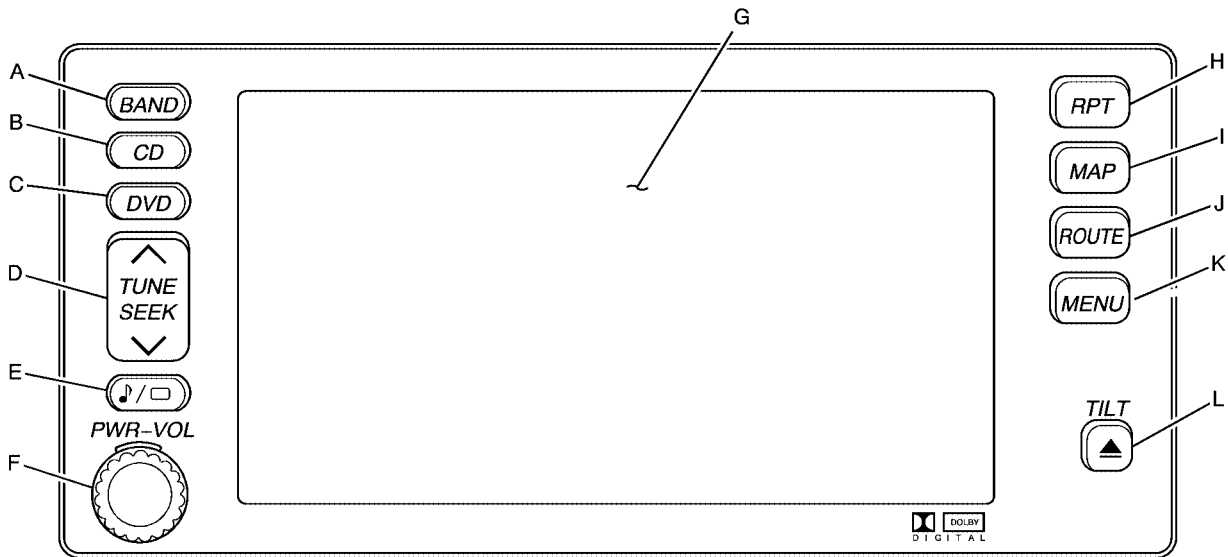



- A. BAND Key. See “Finding a Station” under *Navigation Audio System on page 4-52*.
- B. CD Key. See *Navigation Audio System on page 4-52* or *CD/DVD Player on page 4-68*.
- C. DVD Key. See “Playing a DVD” under *CD/DVD Player on page 4-68*.
- D. TUNE/SEEK Key. See “Playing the Radio” under *Navigation Audio System on page 4-52*.
- E. Audio/Adjust Key. See “Main Audio Menu” under *Navigation Audio System on page 4-52*.
- F. Power-Volume Knob. See “Hard Keys” under *Using the Navigation System on page 4-10*.
- G. Navigation System Screen
- H. RPT (Repeat) Key. See “Hard Keys” under *Using the Navigation System on page 4-10*.
- I. MAP Key. See “Hard Keys” under *Using the Navigation System on page 4-10*.
- J. ROUTE Key. See “Hard Keys” under *Using the Navigation System on page 4-10*.
- K. MENU Key. See “Hard Keys” under *Using the Navigation System on page 4-10*.
- L. TILT Key. See “Hard Keys” under *Using the Navigation System on page 4-10*.

## Getting Started

Read this manual thoroughly to become familiar with how the navigation system operates.

The navigation system includes navigation and audio functions.

Keeping your eyes on the road and your mind on the drive is important for safe driving. The navigation system has built-in features intended to help you do this. Some features may be disabled while driving. Note, these functions are grayed-out. A grayed-out function indicates it is not available when the vehicle is moving.

All functions are available when the vehicle is parked. Do the following before driving:

- Become familiar with the navigation system operation, hard keys on the faceplate, and touch-sensitive screen buttons of the navigation system.
- Set up the audio by presetting favorite stations, setting the tone, and adjusting the speakers.
- Set up the navigation features before beginning driving, such as entering an address or a preset destination.
- Set up the phone numbers in advance so they can be called easily with the press of a single button or a single voice command (for navigation systems equipped with phone capability).

### CAUTION:

Taking your eyes off the road too long or too often while using the navigation system could cause a crash resulting in injury or death to you or others. Focus your attention on driving.

### CAUTION:

Avoid looking too long or too often at the moving map on the navigation screen. This could cause a crash and you or others can be injured or killed. Use the turn-by-turn voice guidance directions whenever possible.

Use the navigation system to:

- Plan a route.
- Select a destination using various methods and choices.
- Follow turn-by-turn route and map guidance with voice prompts, only if permitted by traffic laws, controls, and conditions.

Always be alert, obey traffic and roadway laws, and instructions, regardless of the guidance from the navigation system. Because the navigation system uses street map information that does not include all traffic restrictions or the latest road changes, it may suggest using a road that is now closed for construction or a turn that is prohibited by signs at the intersection. Because the system uses limited information, you must always evaluate whether following the system's directions is safe and legal for the current conditions.

When the navigation system is turned on, a screen may appear with the information below, and you must read and acknowledge the information it contains.

After you acknowledge the start up information you will be able to access the NAV (navigation) and DEST (destination) functions. Once accessed, you can enter or delete information in the navigation system or access other functions. See instructions later in this section.

## Deleting Personal Information

This navigation system can record and store destinations. At times, such as when you are disposing of the vehicle, you may want to delete these destinations. Refer to the following sections to delete the destination information that has been stored.

See “Deleting Single Memory Points”, “Deleting All Memory Points”, “Preset Dests.” (Destinations), “Home” and “Previous Dest.” (Destination) under *Edit Memory Point on page 4-19* for deleting stored destinations.

## Storing Radio Station Presets



To set preset radio stations:

1. Press the PWR/VOL knob to turn the system on.
2. Press the audio source screen button (AM, FM1, FM2, etc.) and select the desired band (AM, FM1, FM2, XM1, or XM2 (if equipped), or WX (weather) (if equipped)).
3. Use the TUNE/SEEK arrows to tune to the desired station.
4. Press and hold one of the six preset screen buttons, at the bottom of the screen, until a beep is heard or see the station displayed on the selected preset button.
5. Repeat the steps for each preset.

See “Preset Station Menu” under *Navigation Audio System on page 4-52* for more information.

## Setting the Clock

To set the time:

1. Press the PWR/VOL knob to turn the system on.
2. Press the  /  (Audio/Adjust) hard key.
3. Press the  clock symbol screen button.
4. Select the 12H or 24H screen button to display the time in standard or military time.
5. Press and hold the HOUR and MIN. (minute) arrow buttons to increase or to decrease the time.
6. Select the appropriate time zone screen button.
7. Select the Daylight Saving Time screen button, if necessary.

The radio uses the GPS satellite to set the time. The vehicle needs to be in an open area to receive the signal. See "Clock Adjust Menu" under *Navigation Audio System on page 4-52* for more information.

## Setting the Search Area, Entering an Address and Point of Interest, Storing a Home Destination, and Using The Home or Previous Destinations

Before entering an Address, Point of Interest, Home, or Preset Destination, select the appropriate region that contains the final destination. The vehicle must be stopped to perform this operation.

### Setting the Search Area

To set the search area:

1. If the radio is already on with a map disc inserted, skip to Step 5.
2. Press the PWR/VOL knob to turn the system on.
3. Insert the DVD map disc. See "Regional Maps" under *Maps on page 4-38* for more information.
4. A notice may appear. Touch the I AGREE screen button to proceed.
5. Press the ROUTE hard key.
6. Press the Enter Destination screen button.
7. Press the Change screen button.
8. Select the appropriate region numbered screen button that contains your final destination.

The system returns to the Destination menu. See *Enter Destination on page 4-27* for more information.

## Entering an Address

To set a destination by entering a street address:

1. If the radio is already on with a map disc inserted, skip to Step 5.
2. Press the PWR/VOL knob to turn the system on.
3. Insert the DVD map disc. See "Regional Maps" under *Maps on page 4-38* for more information.
4. A notice may appear. Touch the I AGREE screen button to proceed.
5. Press the ROUTE hard key.
6. Press the Enter Destination screen button. Verify the selected Search Area is correct.
7. Press the Address screen button.
8. Press the Street screen button, then enter the street name using the alpha keypad on the screen.
9. Select the desired street name with the correct designation (Dr., Ln., St., etc.) from the list.
10. If there is more than one city, the system displays the list of cities that have that street name. Select a city from the list or select the City screen button to input the city name.
11. Enter the house number using the numeric keypad on the screen and touch the Enter screen button. The system lists the house number range available for the street.
12. Press the Enter screen button to plan the route.

See "Address" under *Enter Destination on page 4-27* for more information.

Do not enter directional information or street type, and use the space screen button between street or city names. For example, the street name N. Royal Oak Rd. should be entered as royal oak.

Use the backspace (  ) screen button if an incorrect character has been entered.

## Entering a Point of Interest (POI)

To set a destination by entering a Point of Interest (POI):

1. If the radio is already on with a map disc inserted, skip to Step 5.
2. Press the power/volume knob to turn the system on.
3. Insert the DVD map disc. See “Regional Maps” under *Maps on page 4-38* for more information.
4. A notice may appear. Touch the I AGREE screen button to proceed.
5. Press the ROUTE hard key.
6. Press the Enter Destination screen button. Verify the selected Search Area is correct.
7. Press the All Points of Interest screen button.
8. Enter the specific title of the POI in the Name space (i.e. Washington Monument) using the alpha keypad on the screen.
9. Select the POI from the list.
10. Press the Enter screen button to plan the route.  
Using the Category or City selections aid the system in finding your POI by limiting the search options.

See “All Points of Interest” under *Enter Destination on page 4-27* for more information.

## Storing a Home Destination

1. If the radio is already on with a map disc inserted, skip to Step 5.
2. Press the power/volume knob to turn the system on.
3. Insert the DVD map disc. See “Regional Maps” under *Maps on page 4-38* for more information.
4. A notice may appear. Touch the I AGREE screen button to proceed.
5. Press the ROUTE hard key.
6. Press the Edit Memory Point screen button.
7. Press the Home screen button.
8. Press the Register screen button.  
Select a method for entering a destination. See *Enter Destination on page 4-27* for more information.
9. Press the Enter screen button to store the Home destination.

The  Home icon will be highlighted on the DESTINATION screen. See “Using The Home or Previous Destinations” next to use the home or previous destinations as a route.

## Using The Home or Previous Destinations

These destinations are available for selection while driving.

1. If the radio is already on with a map disc inserted, skip to Step 5.
2. Press the power/volume knob to turn the system on.
3. Insert the DVD map disc. See “Regional Maps” under *Maps on page 4-38* for more information.
4. A notice may appear. Touch the I AGREE screen button to proceed.
5. Press the ROUTE hard key.
6. Press the Enter Destination screen button. Verify the selected Search Area is correct.
7. Select the  (Home symbol) or the Previous Destination screen button.  
If the Previous Destination screen button is selected, a list of the last 10 previous destinations appear. Select the screen button next to the desired destination.
8. Press the Enter screen button to plan the route.

See “Home” and “Previous Destination” under *Enter Destination on page 4-27* for more information.

## Canceling The Current Route

Guidance is canceled once the final destination has been reached. To cancel the current route prior to arrival at the final destination:

1. Press the ROUTE hard key.
2. Press the Route Preference screen button.
3. Press the Cancel Route screen button.
4. Press the Yes screen button to confirm cancellation.

## Guidance Volume

To adjust the volume of voice guidance prompts, do the following:

1. Press the MENU hard key.
2. Press the ON screen button to turn voice volume on.
3. Select the desired volume or select the OFF screen button. The system will play back the new volume level.

See “Voice Guidance Volume Settings” under *Setup Menu on page 4-12* for more information.

# Features and Controls

## Using the Navigation System

This section presents basic information needed to operate the navigation system.

Use the keys located on each side of the navigation screen, as well as the available touch-sensitive screen buttons, to operate the system. See *Navigation System Overview on page 4-2* for more information on location.

Once the vehicle is moving, various functions become disabled to reduce driver distraction.

### Hard Keys

The following hard keys are located to the left of the navigation screen:

**BAND:** Press to access the band screen and switch between AM, FM1, FM2, XM1, XM2, and WX (if equipped). See “Finding a Station” under *Navigation Audio System on page 4-52*.

**CD:** Press to play a CD. The CD screen displays. See *Six-Disc CD Changer on page 4-65* or *CD/DVD Player on page 4-68*.

**DVD:** Press to play a DVD. The DVD screen displays. See *CD/DVD Player on page 4-68*.

**^ TUNE/SEEK v:** Press the up or down arrows to go to the next or previous radio station and stay there. See “Finding a Station” under *Navigation Audio System on page 4-52*.

**🎵 / □ (Audio/Adjust):** Press to view the main audio menu. See “Main Audio Menu” under *Navigation Audio System on page 4-52*.

**PWR-VOL (Power/Volume Knob):** Press the knob to turn the audio and navigation systems on and off. Turn the knob to increase or decrease the volume to the audio system.



The following hard keys are located to the right of the navigation screen:

**RPT:** Press to repeat the current voice guidance navigation prompt.

**MAP:** Press to view the map screen showing current vehicle position.

The map screen can also display the following information:

- North or Heading Up symbol. See *Symbols on page 4-43*.
- Map scale. See *Maps on page 4-38*.
- Distance to destination.
- GPS symbol if GPS signal is not being received. See *Global Positioning System (GPS) on page 4-49*.
- Selected options for reaching your current destination.
- Driver Information.
- Radio band and presets.

**ROUTE:** Press to display the PLAN ROUTE menu. See *Plan Route on page 4-18*.

**MENU:** Press to display the SETUP MENU. See *Setup Menu on page 4-12*.

**TILT ** : Press to open the navigation system faceplate for loading or removing the map DVD, a video DVD, or an audio CD. This key can only be used while the vehicle is in P (Park).

## Alpha-Numeric Keypad

Letters of the alphabet, symbols, punctuation, and numbers, when available, display on the navigation screen as an alpha or numeric keypad. The alpha keypad displays when the system needs a city or street name, entered. A Char at the bottom of the alpha keypad to access the numeric keypad can be touched when entering a house address, punctuation mark, or other character. Touch A - Z to return to the alpha keypad.

All characters are touch-sensitive screen buttons. Touch a character to select it.

Select the space symbol to enter a space between characters or the words of a name.

◀: Select the backspace symbol if an incorrect character has been selected.

To make the name selections easier, the system only allows a selection of a character which can follow the last one entered. For example, if Z is entered, T could not be entered after it. The system highlights the available characters and darkens the unavailable characters.

If unsuccessful when entering a name, it may need to be entered differently. It is also possible that the map DVD database may not contain that information or the correct search area has not been selected. See *Database Coverage Explanations on page 4-52* for more information.

## Touch Sensitive Buttons

Touch-sensitive buttons are located on the screen. After successfully selecting a screen button, a beep is heard. These buttons highlight when a feature is available and are dim when not available. There are some toggle screen buttons that are light blue when active and dark blue when inactive.

## Setup Menu

**MENU:** Press this key, located to the right of the navigation screen, to access the SETUP MENU.

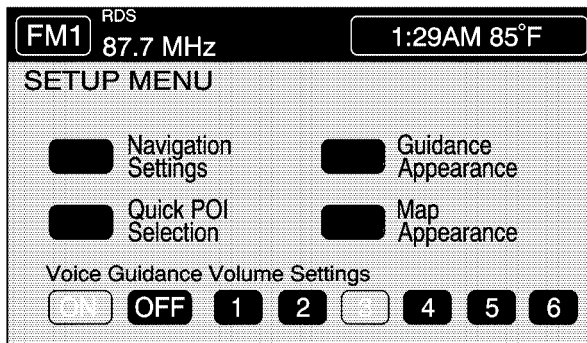

Map appearance, navigation settings, and voice guidance volume can be adjusted in the SETUP MENU.

## Navigation Settings

This menu allows you to change the following options for the navigation system.

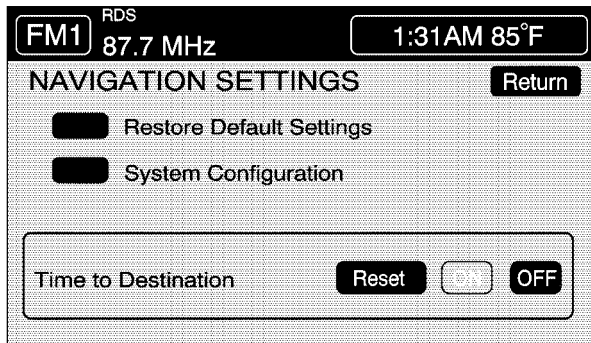

### Restore Default Settings

This feature automatically resets the system to the default values.

To restore the default settings:

1. Touch the Restore Default Settings screen button.
2. Touch Enter.
3. Touch Return to exit this menu.

## System Configuration

This feature allows you to reconfigure the navigation system. If the vehicle is being driven during this procedure, the system will not be able to adjust the position or direction of the vehicle.

Touch the System Configuration screen button to view:

**Adjust Vehicle Position:** To correct the position of the vehicle on the map or to change vehicle position:

1. Touch the Adjust Vehicle Position screen button. The system displays Position Adjustment. The vehicle location symbol and the scroll symbol appear on the map.
2. Use the scroll symbol and the zoom in/zoom out feature to locate the vehicle position on the map.
3. Touch Enter to set the vehicle position. The system displays Position Adjustment and two arrows appear on the map screen.
4. Touch the arrows to adjust the direction of the vehicle. As you touch the arrows, the vehicle symbol direction changes.
5. When the vehicle has been set to the correct direction, touch Enter. Relocation Complete displays.
6. Touch Return to exit this menu.

**Calibrate Vehicle Speed Signal:** If there are tire pressure differences or if a spare tire is installed, the navigation system automatically recalibrates the system. To manually calibrate the system:

1. Touch Start to begin calibration.
2. Touch Return to exit this menu.

## Time to Destination

This feature allows you to view the estimated time to travel from your current position to the destination, and to reset the average speed to factory default settings. Estimated travel time is based on calculated route information and the vehicle's average speed. Touch ON to turn this feature on, OFF to turn this feature off, or Reset to restore vehicle speed default settings. With this feature on, the estimated travel time to destination displays along with the distance to destination.

## Quick POI (Point of Interest) Selection

This menu allows you to choose a point of interest (POI), such as gas stations, restaurants, hotels, etc. to be displayed on the map screen. You can also set a destination to a specific POI.

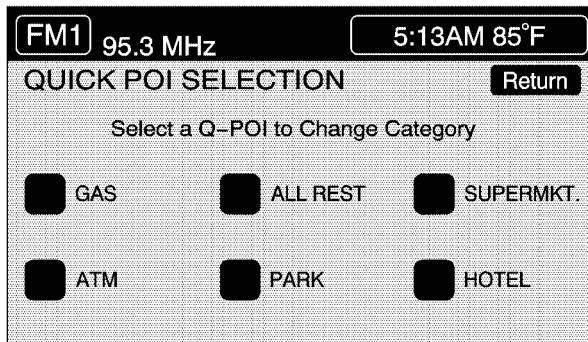

## Setting the Quick POI Menu

To set the Quick POI list displayed on the map screen:

1. Select the category to replace.
2. Select a Quick POI category from the Quick POI selection menu list. The system returns to the Quick POI selection screen when a POI is selected.
3. Touch Return to save the setting and return to the previous menu.

## Displaying Quick POI Icons

To display POI icons of a category on the map screen:

1. Touch the map screen once.
2. Touch the POI button. The Quick POI Selection list displays.
3. Select a category type or touch List Categories or All Local POIs to display the icons of the selected category on the map screen.

## Removing Quick POI Icons

To remove POI icons from the map screen:

1. Touch the map screen once.
2. Touch the POI OFF screen button. The current POI icons are removed from the map screen.

## Setting a Destination Using Quick POI

This feature allows you to choose a POI as the destination. To set a destination using a POI:

1. Touch the POI icon on the map screen to be set as a destination.

The selected icon is surrounded by a blinking box, and the name of the icon displays. You may also touch INFO to view the POI name, address, city, and phone number, if available.

2. Touch the ENT DEST screen button.

If a final destination has already been entered, the POI can be added as a waypoint. See *Edit Waypoint on page 4-23* for more information.

3. Touch Enter to start planning the route.
4. To start route guidance, touch Start or begin driving the vehicle. Route guidance automatically begins after a short distance.

To cancel the route that has just been set:

1. Press the ROUTE hard key.
2. Touch the Route Preference screen button.
3. Touch the Cancel Route screen button.
4. Select YES to cancel or NO to continue.

## Guidance Appearance

This menu allows you to set the guidance appearance screen options. This screen is displayed on the map while on a planned route. The current settings appear as light blue.

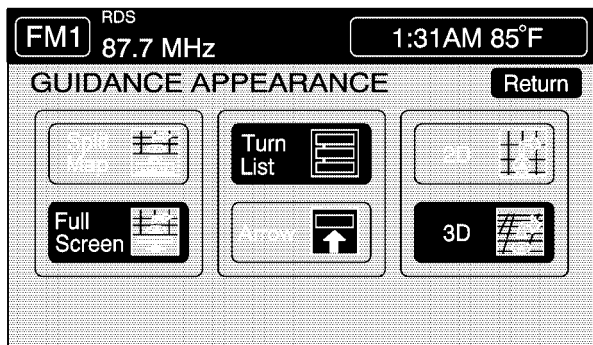

**Split Map:** Select to display the guidance screen on the map at all times.

**Full Screen:** Select to display the guidance screen on the map when approaching a maneuver.

**Turn List:** Select to have the guidance screen display several upcoming turns. Directional arrows, street name, and distance to the next turn displays. As the next turn approaches, the system displays a closer view of the upcoming maneuver.

**Arrow:** Select to have the guidance screen display the next turn. A directional arrow, street name, and distance to the turn displays. As the turn approaches, the system displays a closer view of the upcoming maneuver.

**2D:** Select to display the guidance screen as a two-dimensional view.

**3D:** Select to display the guidance screen as a three-dimensional view.

## Map Appearance

This menu allows you to set the map appearance screen options. The current setting appears as light blue.

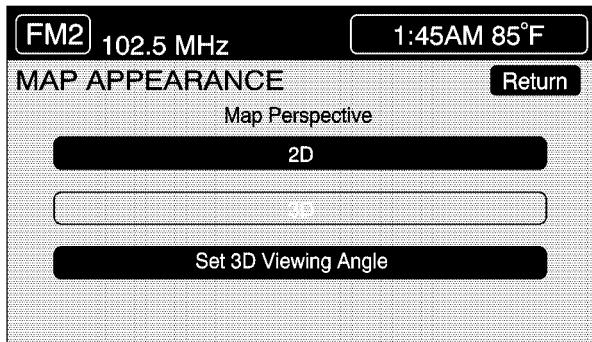

**2D:** Select to display the map as a two-dimensional view.

**3D:** Select to display the map as a three-dimensional view.

**Set 3D Viewing Angle:** This feature allows you to adjust the 3D viewing angle. To do so:

1. Touch 3D on the MAP APPEARANCE menu.
2. Touch Set 3D Viewing Angle.

The map screen with the 3D viewing angle bar displays.

3. Touch the up or down arrows to set the viewing angle.
4. Touch Return to save the settings and to exit this menu or touch Reset to restore the viewing angle to the default setting.

## Voice Guidance Volume Settings

This feature allows you to set the voice prompt volume level or to turn voice prompts on or off.

Set the voice prompt volume level by touching the numbered buttons to increase or decrease the volume level. You may also choose to turn the voice prompts off. Then touch Return to save the setting and to return to the SETUP MENU.

If a voice prompt is active while the audio system is on, the audio system volume decreases and the voice prompts are heard through the driver side front speaker.

Voice prompts are not heard while using voice recognition.

## Plan Route

To plan a route, press the ROUTE key. The PLAN ROUTE menu displays.

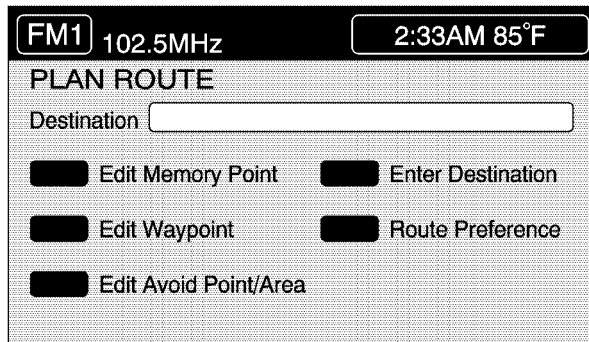

One of several destination entry methods can be used to plan a route. See *Enter Destination on page 4-27* for more information.



## Edit Memory Point

This feature allows you to store, delete, and edit memory points. Touch the Edit Memory Point screen button from the PLAN ROUTE menu to access the EDIT MEMORY POINT screen.

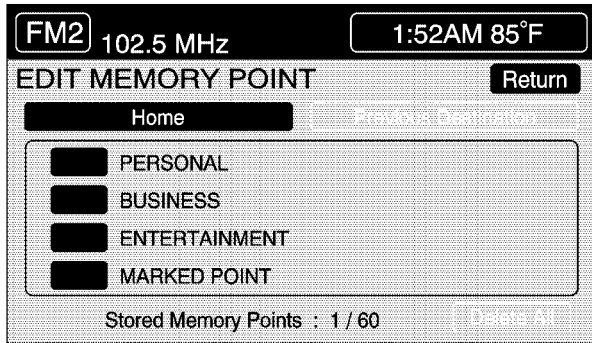

Memory points can be stored in four different categories: personal, business, entertainment, and marked point.

Memory points are stored when either START or MARK are selected when setting a destination on the map or when storing destinations in memory.

A total of 60 locations can be stored. The last 10 destinations entered are stored under Previous Destination. In addition, one memory point can be stored under the Home category.

If all 60 stored points are entered, the system notifies you that there is no available storage left in memory points. A memory point must be removed before storing additional memory points.

## Registering Memory Points

To store a memory point:

1. Select a category from the EDIT MEMORY POINT menu.
2. Touch REGISTER.
3. Select a method for entering a destination. A map appears displaying the memory point's location.
4. If available, touch INFO to view the address information for the memory point.
5. Touch Enter to store the point.

## Editing Memory Points

This feature allows you to edit the contents stored in memory. The following options are available:

### Icon Editing of a Memory Point

Each memory point is displayed with a default icon. To edit an icon:

1. Select the category of the memory point.
2. Select the item to be edited.
3. Touch the icon. The EDIT MEMORY POINT icon screen appears.
4. Touch the icon you would like to use. The system then returns to the EDIT MEMORY POINT menu.
5. Touch Return to go back to the previous screen.

The new memory point icon displays on the map.

Choose from 18 different icons, three of which are sound icons. The same icon may be used for other memory points as well.

## Name Editing of a Memory Point

To modify the name of a stored memory point:

1. Select the category of the memory point.
2. Select the item to be edited.
3. Touch the NAME screen button and use the alpha keypad to edit the name. Names may contain up to 15 alpha and/or numeric characters.
4. Touch Return to go to the previous screen.

## Moving Memory Points

To move a memory point from one category to another:

1. Select the category of the memory point.
2. Select the memory point to be edited.
3. Touch CATEGORY. A list of categories appear. The current category for the item will be highlighted and cannot be selected.
4. Touch the screen button for the category you want the memory point placed in. A pop-up window appears displaying the change in category.
5. Touch Return to go back to the previous screen.

## Adjusting a Memory Point

To relocate a memory point's location:

1. Select the category of the memory point.
2. Select the memory point to be edited.
3. Touch POSITION. A map screen with the position of this memory point appears.
4. Touch anywhere on the screen to activate the scroll feature and relocate the memory point. See *Maps on page 4-38*.
5. Touch Enter to save the memory point's new location.
6. Touch Return to go back to the previous screen.

## Changing the Phone Number of a Memory Point

To edit or add the phone number of a memory point:

1. Select the category of the memory point.
2. Select the memory point to be edited.
3. Touch PHONE and use the numeric keypad to edit or add the number.
4. Touch the RETURN button to take you back to the previous screen when finished.

## Deleting Single Memory Points

To delete a single memory point:

1. Press the ROUTE key.
2. Touch EDIT MEMORY POINT.
3. Select the category of the memory point.
4. Touch DELETE.
5. Select the memory point to be deleted.  
A confirmation window appears.
6. Touch YES to delete the memory point or NO to return to the previous menu.
7. Touch Return to go back to the previous screen.

## Deleting All Memory Points

To delete all of the memory points in a category:

1. Press the ROUTE key.
2. Touch EDIT MEMORY POINT.
3. Select the desired category.
4. Touch the DELETE ALL screen button.  
A confirmation window appears.
5. Touch YES to delete the memory points or NO to return to the previous menu.
6. Touch Return to go back to the previous screen.

## Edit Category

To edit the name of a category:

1. Press the ROUTE key.
2. Touch EDIT MEMORY POINT.
3. Select the category to be edited.
4. Touch the EDIT CATEGORY screen button and use the alpha keypad to edit the category name.  
The name can consist of up to 15 alpha and/or numeric characters.
5. Touch Return to go back to the previous screen.

## Marked Point

A marked point is a memory point which has been stored by selecting the MARK screen button while traveling on a planned route. The scroll feature can also be used to plan a destination on the map after reaching the destination, or by moving a memory point to a marked point category. See “Editing Memory Points” earlier in this section for more information.

## Previous Destination Memory

Each time Start is selected from the map screen, that destination is stored as a memory point under PREVIOUS DESTINATION. This category stores up to 10 destinations.

When the Previous Destination category contains more than 10 destinations, the system removes the oldest destination stored and adds the most recent one selected to the list.

So that a previous destination is not lost, move the destination into a memory point category. See “Moving Memory Points” earlier in this section for more information.

## Home Memory

This memory point is stored by selecting Home from the EDIT MEMORY POINT screen. See “Registering Memory Points” earlier in this section and “Home” under *Enter Destination on page 4-27* for more information.

## Edit Waypoint

Waypoints are destinations you can set along the way to your final destination. This feature allows you to add, edit, and delete waypoints.

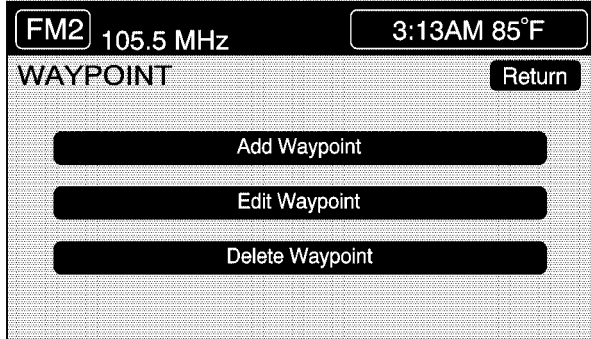

Five waypoints can be set up on the way to the final destination.

To access the WAYPOINT menu:

1. Press the ROUTE key.
2. Touch Edit Waypoint.

## Adding a Waypoint

To add a waypoint to the route:

1. Touch Add Waypoint.
2. Enter a destination. See *Enter Destination on page 4-27*.  
A map appears showing the location of the waypoint.
3. Touch Enter to add the waypoint.
4. Touch the ADD screen button to insert the waypoint in the desired order.
5. The system displays the ROUTE INFORMATION screen. From this screen, several options are available.

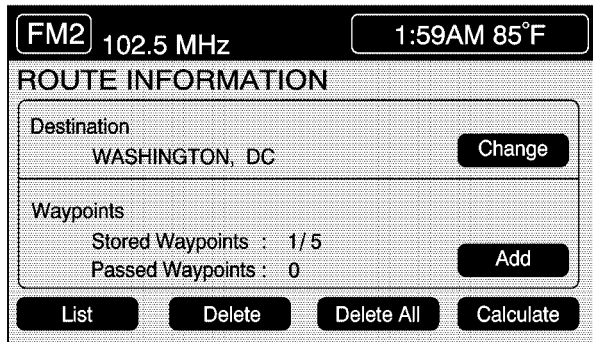

**List:** Touch to view the waypoint on the map or to change the order of the waypoints and final destination. To change the order, touch CHG ORDER, then touch the blank screen button next to the destination to select the order of the waypoints and final destination. Press the MAP key to view the destination and waypoints on the map screen.

**Delete:** Touch to delete a waypoint or the final destination. A confirmation window appears. Touch YES to delete the point or NO to return to the previous screen.

**Delete All:** Touch to delete all of the waypoints and the final destination. A confirmation window appears. Touch YES to delete all waypoints or NO to return to the previous screen.

**Change:** Touch Change to change the final destination. Enter a destination. See *Enter Destination on page 4-27*.

**Add:** Touch to add additional waypoints. Refer to the steps for adding a waypoint listed previously in this section.

**Calculate:** Touch to begin route calculation. This feature is only available if the final destination has been set.

## Editing a Waypoint

This feature allows editing of waypoints that have already been set. To edit a waypoint:

1. Touch Edit Waypoint.
2. Touch the MAP key to view the destination location on the map screen.
3. Touch CHANGE ORDER to change the order of the waypoints and the final destination.

The map scroll can be used to change a waypoint from one location to another.

## Deleting a Waypoint

To delete a waypoint from the route:

1. Touch Delete Waypoint.
2. Select the waypoint to be deleted. A confirmation window appears.
3. Touch YES to delete the waypoint or NO to return to the previous menu.

## Edit Avoid Point/Area

From this menu you can register, edit, and delete an area to be avoided while planning a route. These areas can also be saved so the system can automatically avoid them when planning a route.

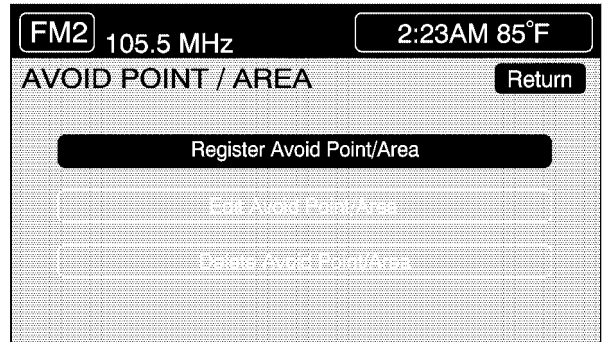

To access the AVOID POINT/AREA menu:

1. Press the ROUTE key.
2. Touch Edit Avoid Point/Area.

## Registering an Avoid Point/Area

To store an avoid point/area:

1. Touch Register Avoid Point/Area.
2. Enter a location. See *Enter Destination on page 4-27*.
3. If desired, reduce or enlarge the area around the point you want to avoid by using the REDUCE or ENLARGE screen buttons.

If an avoid point cannot be avoided, the system displays "Avoid Point and Area Stored. Route May Not Avoid the Avoid Point and Areas."

4. Touch Enter to set the area as an avoid point area. When using the REDUCE or ENLARGE buttons, a box appears to represent the area or an X appears to represent the area avoided. When an avoid point is set, the square will appear as green.
5. Touch Return to go back to the previous screen.

## Editing an Avoid Point/Area

To edit an avoid point/area:

1. Touch Edit Avoid Point/Area. A list of avoided points appear.
2. Select the avoided point/area you want to change. A map of the avoided area appears.
3. Use REDUCE or ENLARGE to edit the avoided point.
4. Touch Enter to set your new avoided area. The system displays "Area Adjusted."
5. Touch Return to go back to the previous screen.

## Deleting an Avoid Point/Area

To delete an avoid point/area:

1. Touch Delete Avoid Point/Area. A list of avoided points appear.
2. Select the avoided point/area to be deleted.
3. The system will ask to confirm the selection. Touch Yes to delete the avoid point/area or No to cancel.  
If Yes is selected, the area will no longer be avoided when traveling on a planned route.
4. Touch Return to go back to the previous screen.



## Enter Destination

The DESTINATION menu gives you several ways to plan a route. Touch the Enter Destination screen button from the PLAN ROUTE menu to display the DESTINATION menu.

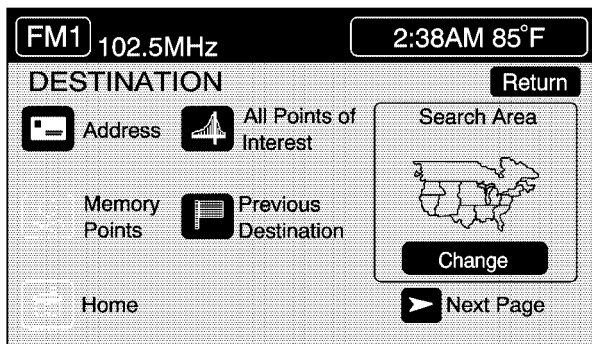

For destination entry methods listed on the second page of the DESTINATION menu, touch the Next Page arrow. Touch the Prev. Page arrow to return to the first page.

To enter a destination, choose from one of the destination entry methods following in this section.

After entering a destination, if available, the system displays up to three routes in a pop-up window indicating the total mileage and time to destination for each route. Select a route by touching NEXT. The map displays each route in a different color. The selected route highlights in red.

To start route guidance, touch Start or begin driving the vehicle. Route guidance automatically begins after a short distance.

If CHG ROUTE is touched before touching Start, route preferences can be changed. See *Route Preference on page 4-36* for more information.

When a route has been planned, it highlights and a bulls-eye symbol appears on the map to show the final destination.

To cancel a route that has been set, see "Cancel Route" under *Route Preference on page 4-36*.

## Easy Planning Route

With this destination entry method, a destination can be selected by using the scroll symbol on the map screen. See *Maps on page 4-38*.

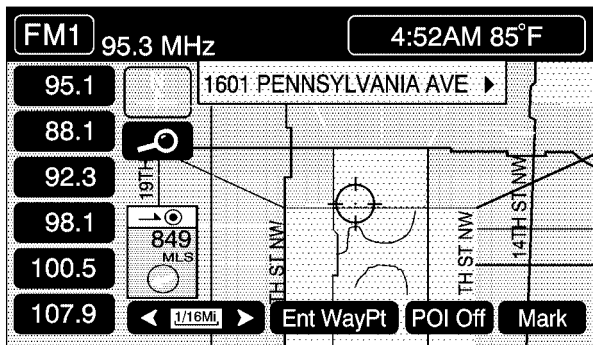

To use this destination entry method:

1. Press the MAP key.
2. Touch the map screen twice for the scroll symbol to appear. Touch the map or drag the scroll symbol toward the destination.

3. Touch the map screen continuously to scroll through the map faster. The address of the location on the map appears at the top of the screen.

If needed, use the zoom feature to locate the destination. See "Map Scales" under *Maps on page 4-38* for more information.

4. Touch ENT DEST to set this location as the destination. Touch MARK to also store this location as a memory point.
5. Touch Enter to plan the route.

## Address

This destination entry method allows input of an address by providing the system with a house number, street name, and city. Select Street to begin entering the desired address.

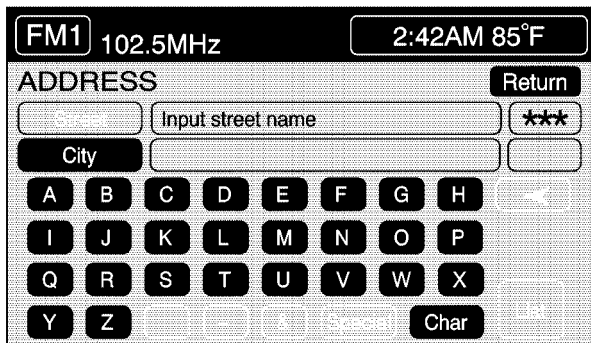

To use this destination entry method:

1. Enter the street name using the alpha keypad. See “Alpha-Numeric Keypad” under *Using the Navigation System on page 4-10* for more information.

Do not include name extensions such as N. or Drive. For example, the street name N. Civic Center Drive should be entered as Civic Center. As information is entered, the system automatically searches for available names, and List becomes available.

2. Touch List to view name choices or continue to spell the street name to further reduce the number of available items. Select a street name.
3. If the street name entered exists in more than one city on the DVD database, a list of cities appear. Select a city from the list, or enter the city name by selecting City. While entering the city name, the desired city can be selected from the list which appears, or continue to spell the city name to further reduce the number of available items.
4. Once the city name has been selected, enter the house number using the numeric keypad. The system lists the house number range that is available for the street.
5. After entering all of the address information, touch Enter to plan the route.

## All Points of Interest

This destination entry method allows you to choose a destination from the point of interest (POI) list. Selecting All Points Of Interest from the DESTINATION menu brings up the alpha keypad. While inputting a POI or city name, the List option will become available. As information is entered, the system searches for available POI and city names based on the information given. The system supplies a list of names to make a selection from when the choices are five or less.

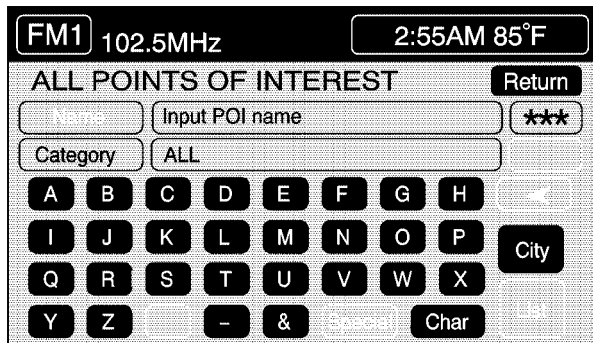

You may search for a POI using the following three methods:

- Touch NAME to type in a POI by name using the alpha key pad. As you type in a name, the system searches for an available match to your input. Select the desired POI.
- Select a POI by touching CATEGORY. Use the arrows to scroll through the categories listed. Select a category along with any appropriate sub-categories. If the list of available POIs for the selected category is too long, the POI's name or city may need to be entered.
- Select CITY, then type in the city from which a POI is selected. Choose a city from the list of cities that appears. If the list of POIs for the selected city is too long, enter the POI's name or choose a category.

While entering a POI or city name, the List option becomes available. Touch List to view the list of name choices, or continue to spell the name to further reduce the list of available items.

The system lists all POIs available. Sort by name using NAME SORT or touch DIST SORT to list POIs by distance from the current location.

The screenshot shows a pop-up window with a black header bar. On the left, it says 'FM1 102.5MHz'. On the right, it shows '3:00AM 85°F'. Below the header, the title is 'POI INFORMATION' and there is a 'Return' button. The main content area is a table with four rows: 'Name : SMITH'S GARDEN RESTAURANT', 'Address : 10 S. MAIN', 'City : WOODBURY, NJ', and 'Phone : (555) 444-3322'.

POI INFORMATION		Return
Name :	SMITH'S GARDEN RESTAURANT	
Address :	10 S. MAIN	
City :	WOODBURY, NJ	
Phone :	(555) 444-3322	

Select a location from the list. The system shows the selected POI on the map. If available, a pop-up window displays. Touch INFO to view the POI's name, address, city, and phone number, if available.

Touch Enter to plan the route.

## Memory Points

This destination entry method allows a memory point to be set as the destination. Each time a destination from the map screen is stored, the destination is stored under MARKED POINT. See *Edit Memory Point on page 4-19* for more information.

The screenshot shows a window with a black header bar. On the left, it says 'FM1 102.5MHz'. On the right, it shows '3:03AM 85°F'. Below the header, the title is 'MEMORY POINT' and there is a 'Return' button. The main content area is a list of four categories, each with a square selection box: 'PERSONAL', 'BUSINESS', 'ENTERTAINMENT', and 'MARKED POINT'. The 'MARKED POINT' box is currently selected and filled with black.

MEMORY POINT		Return
<input type="checkbox"/>	PERSONAL	
<input type="checkbox"/>	BUSINESS	
<input type="checkbox"/>	ENTERTAINMENT	
<input checked="" type="checkbox"/>	MARKED POINT	

Destinations must be stored as memory points to select from PERSONAL, BUSINESS, ENTERTAINMENT, or MARKED POINT. If you have renamed the memory point category name(s), the name(s) appear as you changed them.

To select a destination using this entry method:

1. Touch the Memory Points symbol.
2. Select a category.
3. Select a destination. Use the arrows to scroll through the memory points. They can be sorted by date, name, distance, and icon.
4. Touch Enter to plan the route.

## Previous Destination

This destination entry method allows selection of a destination by choosing from a list of the last 10 destinations entered into the system.



To select a previous destination:

1. Touch the Previous Destination symbol.
2. Touch the screen button next to the desired destination to select it.  
Use the arrows if necessary to view the entire list of previous destinations.
3. Touch Enter to plan the route.

## Previous Starting Point

This destination entry method allows selection of the last start point as the destination. To select the previous start point as the destination:

1. Touch Previous Destination.
2. Touch the Previous starting point screen button.
3. Touch Enter to plan the route.

## Home

This destination entry method allows selection of a destination that has been previously stored as Home.

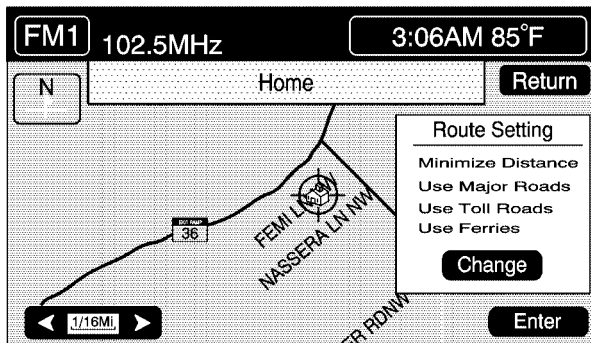

To choose Home as the destination:

1. Touch the Home symbol.
2. Touch Enter to plan the route.

## Set by Map

This destination entry method allows selection of a destination by using the scroll symbol.

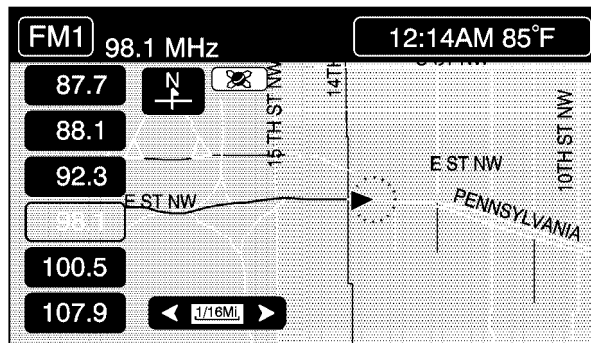

To use this feature:

1. Touch the Set By Map symbol. Current vehicle position is shown on the map screen.
2. Use the scroll symbol to select the desired destination. The zoom in and zoom out feature can be used to assist in finding the desired location. See "Map Scales" under *Maps on page 4-38*.
3. Touch Enter to plan the route.

## Freeway Entrance/Exit

This destination entry method allows selection of either a freeway entrance or an exit as a destination.

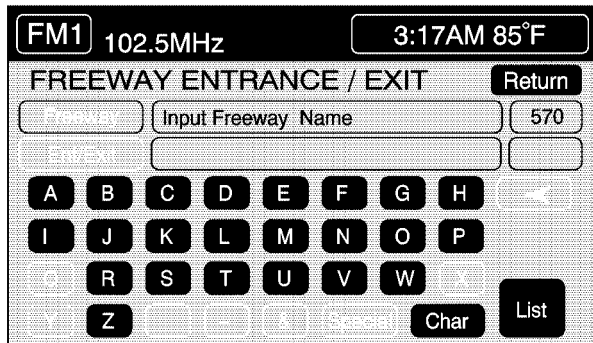

To enter a freeway name:

1. Touch the Freeway Entrance/Exit symbol.
2. Enter the freeway name using the alpha key pad. Freeways sometimes have a name and a number associated with them which may need to be referred to when entering freeway information. Freeways are also referred to by their abbreviated names. For example, Interstate 75 in the U.S. is selected by entering I-75. While entering a freeway name, the List option becomes available.

3. Touch List to view the list of available name choices or continue to spell the name to further reduce the list of available items. The system supplies a list of names when the choice is five or less.

If unsuccessful when inputting a name, the name may need to be input differently, the map DVD database may not contain this information, or the name may be misspelled.

4. Select a freeway from the list.
5. The ENTRANCE or EXIT options will appear. Choose ENTRANCE to select the entrance to the freeway, or EXIT to select the exit ramp of the freeway.

When either button is touched, it gives an alphabetical list of freeway entrance and exit ramps on the freeway that were entered. Touch DIST SORT to sort the list by distance from the current location, or NAME SORT to sort the list by name.

6. Select the desired freeway entrance or exit from the list. A map appears with the destination shown.
7. Touch Enter to plan the route.



## Intersection

This destination entry method allows selection of a destination by inputting the intersecting roads of the destination.



To enter an intersection:

1. Touch the Intersection symbol.
2. Using the alpha keypad, enter the name of the first street in the intersection.

3. To view a list of choices, touch List or continue to spell the name to further reduce the list of available items. The system will display a list of the intersecting streets if the number of intersecting streets is five or less.
4. Select the first street.
5. Now enter the second street name.
6. Select the second street name from the list of intersecting streets. To view a list of choices, touch List or continue to spell the name to further reduce the list of available items. The system displays a list of intersecting streets if the number of intersecting streets is five or less.  
  
If there are multiple intersections with the same two roads, the system displays a list of cities to choose from. Choose a city from this list. A map with the intersections for that city appears.
7. Touch Enter to plan the route.

## Route Preference

To change the planning options:

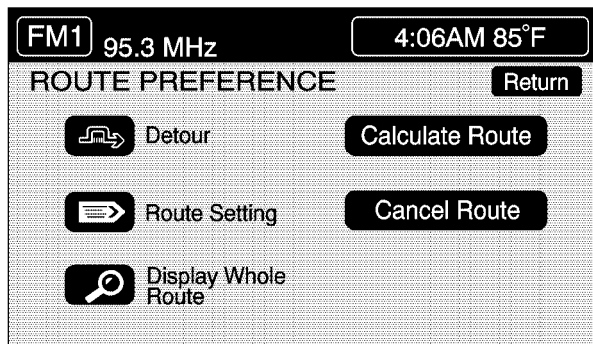

1. Press the ROUTE key.
2. Touch Route Preference.

The following options are available from the ROUTE PREFERENCE menu:

### Detour

This feature allows you to choose a distance in miles/kilometers to detour. Select the detour distance desired for residential roads and freeways.

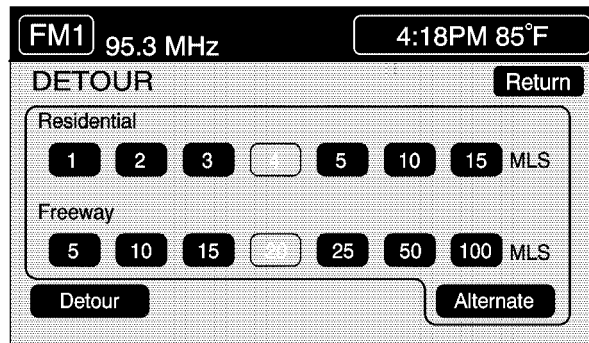

These settings are retained the next time Detour is used until the settings are changed.

Alternate can also be touched to provide a new route that does not use previously stored detour settings.

Touch Return to go back to the previous screen.

## Route Setting

This feature displays and changes the planning methods used each time you plan a route. Planning method options, allowing selection of the fastest route based on time or distance, using only major roads, toll roads, and using ferries based on the navigation system's information and information contained on the map DVD.

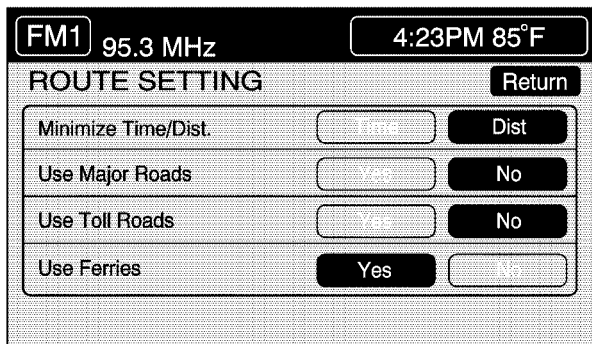

The following options are available from the ROUTE SETTING menu:

**Minimize Time/Distance:** The system calculates the fastest route or shortest route possible. Choose Time for the fastest route or Dist for the shortest route.

**Use Major Roads:** Choose Yes to calculate the best route using only major roads unless a route cannot be found without the use of a secondary road. This selection will not always offer the shortest distance or time to your destination.

**Use Toll Roads:** Choose Yes to calculate the best route using toll roads wherever possible. This selection will not always offer the shortest distance or time to your destination.

**Use Ferries:** Choose Yes to calculate the best route using ferries when possible. This selection will not always offer the shortest distance or time to your destination.

## Display Whole Route

This feature allows the entire planned route to be displayed. Total mileage and time to destination for the planned route displays on the map screen. Touch Return to go back to the previous menu.

## Calculate Route

This feature allows route calculation for the selected destination.

## Cancel Route

To cancel a planned route while traveling on it, touch Cancel Route. The system will ask for confirmation by touching YES. Touch YES to confirm cancellation of the planned route or touch Return to keep the planned route.

## Maps

This section includes basic information needed to understand the map database.

The maps are stored on a DVD-ROM. The 48 contiguous United States and portions of Canada are contained on two discs. To minimize the necessity of changing the discs, both map discs cover US6, US7, and Canada.

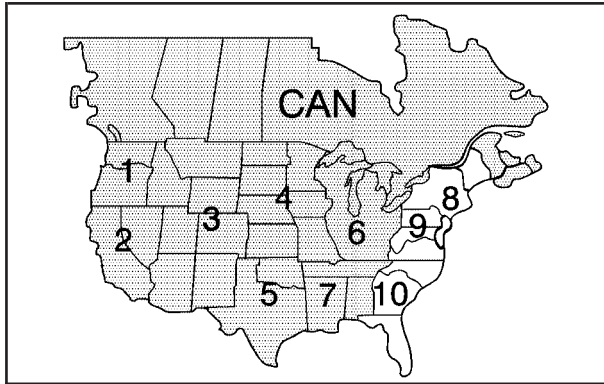

West

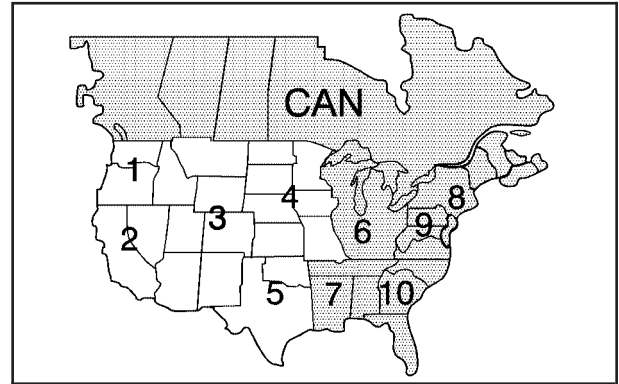

East

## Installing the DVD Map Disc

Your dealer/retailer may have installed the map DVD. If the map DVD was not installed, do the following to load it:

1. Turn the ignition on.
2. With the vehicle in P (Park), press and hold the TILT key until a beep is heard. The system's faceplate opens.
3. If already loaded, the map DVD or a CD ejects from the slot.
4. Load the map DVD into the slot by inserting it partway. The system pulls it in.
5. Press and release the TILT key to close the faceplate.

**Notice:** Shifting out of P (Park) with the system's faceplate open will cause the faceplate to close automatically. This could cause damage to a CD, DVD or the system if it is partially loaded. Before shifting out of P (Park), make sure that the DVD or CD is loaded properly. The vehicle must be shifted back into P (Park) to close the faceplate.

Once the map DVD is inserted correctly, you will have the following two choices:

- LANGUAGE
- I AGREE

The language can be changed at this time. See "Language" under *Navigation Audio System on page 4-52* for more information on choosing a language. Once a language has been selected, touch I AGREE to plan a route. The map appears showing the current vehicle position.

## DVD Map Disc Messages

If an error appears on the display and/or the map disc comes out, it could be for one of the following reasons:

- If the map disc was installed into the CD slot. See “Installing the DVD Map Disc” previously.
- It is very hot, when the temperature returns to normal, the map disc should play.
- You are driving on a very rough road. When the road becomes smoother, the map disc should play.
- The map disc is dirty, scratched, wet, or upside down.

If any error occurs repeatedly or if an error cannot be corrected, contact your dealer/retailer.

## Ejecting the DVD Map Disc

When the DVD map disc is not loaded, the navigation portion of the system cannot be used.

1. Turn the ignition on.
2. With the vehicle in P (Park), press and hold the TILT key until a beep is heard. The system’s faceplate opens.
3. The map DVD ejects from the slot. Pull the disc out.
4. Press and release the TILT key to close the faceplate.

**Notice:** Shifting out of P (Park) with the system’s faceplate open will cause the faceplate to close automatically. This could cause damage to a CD, DVD or the system if it is partially loaded. Before shifting out of P (Park), make sure that the DVD or CD is loaded properly. The vehicle must be shifted back into P (Park) to close the faceplate.

## Handling the DVD Map Disc

When handling the DVD map disc, be careful of the following:

- Handle the disc very carefully to avoid contamination or flaws. Signals may not read out properly if the disc gets contaminated or flawed.
- If the disc gets soiled, use a soft cloth to gently wipe it out from the center of the disc to the outside. Do not use photographic record cleaner, solvents, or other cleaners.
- Do not use the disc to rest on while writing or drawing using any writing utensil or attach a seal to any of the sides or the disc.
- Do not keep the disc in direct sunlight, high temperatures, or humidity.
- After using the disc, place it back into the original case.

## Setting the Search Area

To determine or change the system's search area:

1. Press the ROUTE key.
2. Touch the Enter Destination screen button.
3. Touch Change under the Search Area heading. The system displays a map with each region represented.

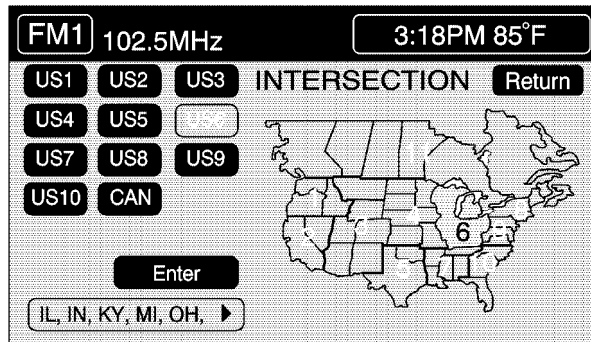
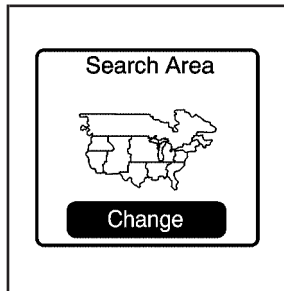

4. Select the desired region by touching the appropriate screen button to the left of the U.S. map. The name of the states or the country included in the selected region displays at the bottom of the screen and the region is highlighted.
5. Touch Enter to set the region as the search area.
6. Touch Return to go back to the previous screen.

## Map Adjustments

The system allows the adjustment of the scale of view on the map. The map scrolls automatically based on the direction being traveled.

### Map Scales

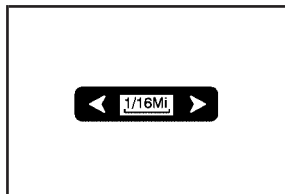

To view a larger or smaller scale of the map, touch the map scale arrows.

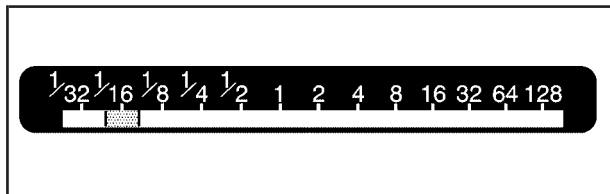

The scale of the map can also be adjusted by touching the scale on the bar. The scale of a map can range from 1/32 of a mile (0.05 km) to 128 miles (256 km).

## Scrolling the Map

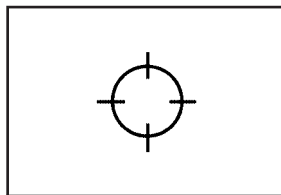

Touch anywhere on the map screen twice to display the scroll symbol.

Place your finger on the map screen in any direction outside of the scroll symbol to scroll in that direction. The map continues to scroll until your finger is removed from the screen.

If the vehicle is in P (Park), the system initially scrolls at a slower rate. The rate increases while continuing to touch the map screen.

If the vehicle is in motion, there is one scroll speed and a limited distance to scroll. Keep touching the map screen to scroll a longer distance.

If the vehicle icon becomes lost while scrolling, press the MAP key to show the vehicle's current location.

The scroll feature can be used to set a destination. See "Set by Map" under *Enter Destination on page 4-27*.



## Symbols

The following symbols are the most common that appear on a map screen.

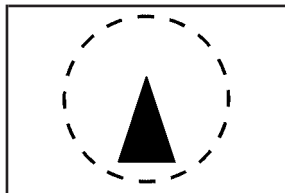

The vehicle is shown as this symbol. It indicates the current position and its heading direction on the map.

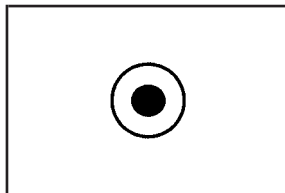

This symbol appears on the map to show the destination after a route has been planned.

See *Enter Destination* on page 4-27 for more information on planning a route.

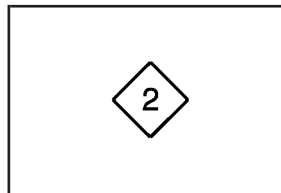

This type of symbol on the map displays when a waypoint has been planned.

The waypoint symbol is numbered from 1 through 5 depending on how many waypoints have been set. See *Edit Waypoint* on page 4-23 for more information on adding waypoints.

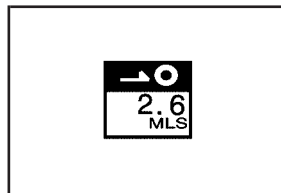

This symbol indicates the distance to the final destination.

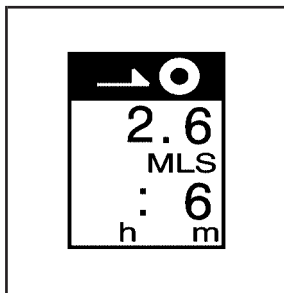

This symbol indicates the distance and estimated travel time to the final destination. The Estimated Travel Time feature must be on for estimated travel time to be displayed.

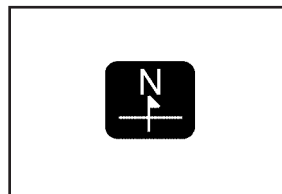

This symbol indicates the map with North up.

While in North up mode, North is always be at the top of the map screen regardless of which direction the vehicle is traveling.

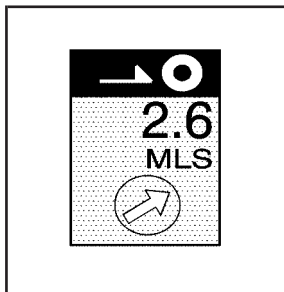

This symbol indicates the distance to the final destination in a straight line.

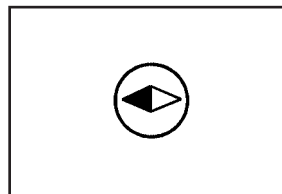

This symbol indicates the map with the vehicle travel direction up, or Heading up.

The shaded triangle indicates North. While in Heading up mode, the direction the vehicle is being travelled will always be at the top of the map screen.

Touch either the North Up heading symbol or the vehicle Heading Up symbol to alternate between settings.

This symbol appears before route guidance begins or if the vehicle is on a road where route guidance is not available.

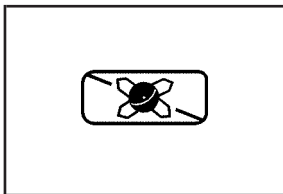

This symbol appears when the navigation system is unable to receive the GPS signal.

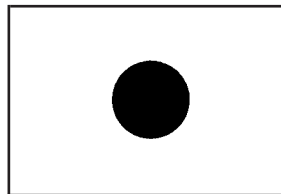

This symbol indicates the position of the next turn instruction.

See *Global Positioning System (GPS)* on page 4-49 for more information.

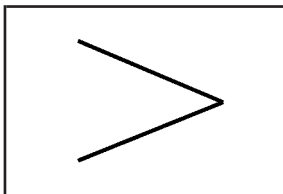

When a point of interest (POI) or street address name is too long to be displayed, an arrow appears.



While on a planned route, touch this symbol to display the DEST MAP, WHOLE, and TURN LIST options.

Touch the right or left arrow to scroll through the entire name.

With these options, the following can be done:

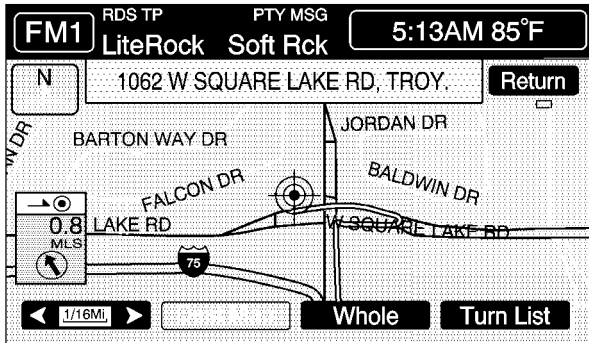

**Dest (Destination) Map:** This option allows viewing of the final destination location. The destination's name or address displays on the map screen. Touch Return when finished.

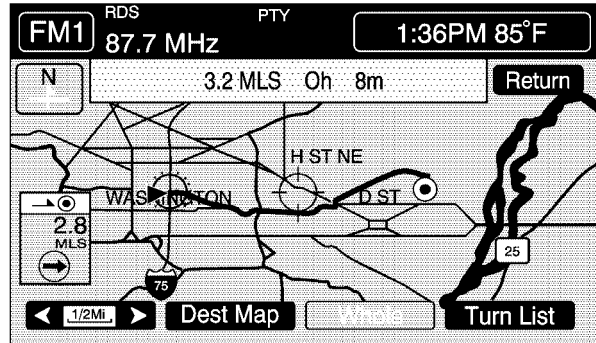

**Whole:** This option allows viewing of the entire planned route. The distance to destination displays on the map screen. Touch Return when finished.

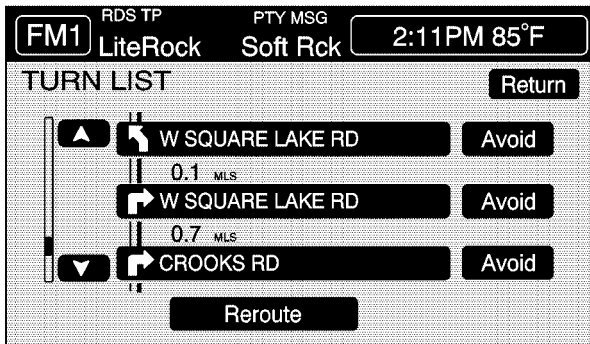

**Turn List:** This option allows viewing of a step-by-step listing of upcoming street names, the distance that you will travel on the road, and turns needed to make during the planned route.

After touching Turn List, the system may take some time to create the list. The length of time varies depending on the length of the route and the planning methods selected.

The turn list reads from bottom to top. The bottom street name is the street you are currently on. The system automatically updates this screen as each turn is made. Touch the scroll up and down arrows, providing scroll is available. Touching the down arrow gives the current location. Touching the up arrow gives upcoming streets. At times, there may not be names available for entrance or exit ramps.

To avoid a turn, touch AVOID next to the turn to be avoided. Use REDUCE or ENLARGE to edit the avoided point. Touch Reroute or press the MAP key to calculate the new route.

Touch Return to view the current position and to turn the turn list screen off.

Touch REROUTE or press the MAP key to calculate a new route.

## Auto Reroute

When the destination is set and you travel off of the planned route, the system automatically begins to reroute. The new route highlights on the screen.

## Traveling Across Regions

If driving across several states, the selected region might have to be changed to represent the destination.

There are two ways to plan a destination when traveling across regions.

The following method is suggested and provides the most route guidance and map display functions:

1. Change the selected search area region as you get closer to the destination. See “Setting the Search Area” under *Maps on page 4-38*.
2. Enter the destination and route settings. See *Enter Destination on page 4-27* for more information.

If not using the first method, keep the currently selected search area region and enter the destination. This method allows a destination selection from the easy planning route method or from the All Points of Interest (POI) categories with the “All Search Areas” comment for US Only. For example, Tourist is a category that features this comment. See *Enter Destination on page 4-27* for more information.

If traveling in or to Canada and the regional border is crossed, the only map scale views available are 4 mi, 8 mi, 31 mi, and 128 mi (8 km, 16 km, 64 km and 256 km). Change the selected search area region when you get closer to the destination. See “Setting the Search Area” under *Maps on page 4-38* for more information.

## Keyless Access System

When the engine is started, Driver 1 or Driver 2 displays on the screen. A message will not appear on the screen if the driver is unknown. The number on the back of the transmitter corresponds to driver 1 or driver 2. The navigation system can store memory points for drivers 1 and 2 individually. See *Keyless Access System Operation on page 2-5* for more information.

## OnStar<sup>®</sup> System

When using the OnStar<sup>®</sup> system, the audio system mutes and the navigation voice prompts become disabled during the call. The volume of the OnStar call can be adjusted by using the steering wheel volume controls. See *OnStar<sup>®</sup> System on page 2-42* for more information.

## Global Positioning System (GPS)

The navigation system determines the position of the vehicle by using satellite signals, various vehicle signals, and map data.

At times, other interferences such as the satellite condition, road configuration, the condition of the vehicle and/or other circumstances can interfere with the navigation system's ability to determine the accurate position of the vehicle.

The GPS shows the current position of the vehicle using signals sent by the GPS Satellites of the United States Department of Defense. When the vehicle is not receiving signals from the satellites, a symbol appears on the map screen. Refer to *Symbols on page 4-43*.

This system may not be available or interferences may occur if any of the following is true:

- Signals are obstructed by tall buildings, trees, large trucks, or a tunnel.
- Objects are located on the rear shelf of the vehicle.
- Satellites are being repaired or improved.
- After-market glass tinting has been applied to the vehicle's rear windshield.

**Notice:** Do not apply after-market glass tinting to the vehicle's windows. Glass tinting interferes with the system's ability to receive GPS signals and causes the system to malfunction. The window might have to be replaced to correct the problem. This would not be covered by the warranty.

For more information if the GPS is not functioning properly, see *If the System Needs Service on page 4-51* and *Problems with Route Guidance on page 4-51*.

## Vehicle Positioning

At times, the position of the vehicle on the map may be inaccurate due to one or more of the following reasons:

- The road system has changed.
- The vehicle is driving on slippery road surfaces such as in sand, gravel, and/or snow.
- The vehicle is traveling on winding roads.
- The vehicle is on a long straight road.
- The vehicle is approaching a tall building or a large vehicle.
- The surface streets run parallel to a freeway.
- The vehicle has just been transferred by a vehicle carrier or a ferry.
- The current position calibration is set incorrectly.
- The vehicle is traveling at high speed.
- The vehicle changes directions more than once, or when the vehicle is turning on a turn table in a parking lot.

- The vehicle is entering and/or exiting a parking lot, garage, or a lot with a roof.
- The GPS signal is not received.
- A roof carrier is installed on the vehicle.
- The vehicle is being driven with tire chains.
- The tires are replaced.
- The tire pressure for the tires is incorrect.
- The tires are worn.
- The first time the map DVD is inserted.
- The battery is disconnected for several days.
- The vehicle is driving in heavy traffic where driving is at low speeds, and the vehicle is stopped and started repeatedly.

If problems are experienced with the navigation system, see “Adjust Vehicle Position” under *Setup Menu on page 4-12* to calibrate the system.



## Problems with Route Guidance

Inappropriate route guidance may occur under one or more of the following conditions:

- You have not turned onto the road indicated.
- Route guidance may not be available when using automatic rerouting for the next right or left turn.
- The route may not be changed when using automatic rerouting.
- There is no route guidance when turning at an intersection.
- Plural names of places may be announced occasionally.
- It may take a long time to operate automatic rerouting during high-speed driving.
- Automatic rerouting may display a route returning to the set waypoint if you are heading for a destination without passing through a set waypoint.

- The route prohibits the entry of a vehicle due to a regulation by time or season or any other regulation which may be given.
- Some routes may not be searched.
- The route to the destination may not be shown if there are new roads, if roads have recently changed, or if certain roads are not listed on the map DVD. See *Ordering Map DVDs on page 4-52*.

To recalibrate the vehicle's position on the map, see "Adjust Vehicle Position" under *Setup Menu on page 4-12* to calibrate the system.

## If the System Needs Service

If the navigation system needs service and the steps listed here have been followed but there are still problems, see your dealer/retailer for assistance.

## Ordering Map DVDs

The map DVD in the vehicle is the most up-to-date information available when the vehicle was produced. The map DVD is updated periodically, provided that the map information has changed.

If there are any questions about the operation of the navigation system or the update process, contact the GM Nav Disc Center toll-free phone number, 1-877-NAV-DISC (1-877-628-3472) or go to the center's website, [www.gmnavdisc.com](http://www.gmnavdisc.com).

If you need any updates or a replacement disc, because the current disc is lost, damaged, or needs to be updated, call the GM Nav Disc Center or order a new disc online. To order a disc, have your Vehicle Identification Number (VIN) available. This helps the center make sure you receive the correct and most up-to-date DVD map disc for your vehicle. See *Vehicle Identification Number (VIN) on page 6-81* for more information.

After receiving the updated disc, replace the old disc in the navigation system. See "Installing the DVD Map Disc" and "Ejecting the DVD Map Disc" under *Maps on page 4-38*. Dispose of the old disc to avoid confusion about which disc is the most current.

## Database Coverage Explanations

Coverage area depends upon the map detail available. Some areas have greater map detail than others. The navigation system works only as well as the information provided on the map disc. See *Ordering Map DVDs on page 4-52* on how to obtain updated map information.

## Navigation Audio System

**Notice:** Before adding any sound equipment to the vehicle, such as an audio system, CD player, CB radio, mobile telephone, or two-way radio, make sure that it can be added by checking with your dealer/retailer. Also, check federal rules covering mobile radio and telephone units. If sound equipment can be added, it is very important to do it properly. Added sound equipment can interfere with the operation of the vehicle's engine, radio, or other systems, and even damage them. The vehicle's systems can interfere with the operation of sound equipment that has been added.

The vehicle has a feature called Retained Accessory Power (RAP). With RAP, the audio system can be played even after the ignition is turned off. See *Retained Accessory Power (RAP) on page 2-25* for more information.

The audio system is operated using navigation system menus. The audio menus are explained in this section.

## Main Audio Menu

 /  (Audio/Adjust): Press this key to view the main audio screen.

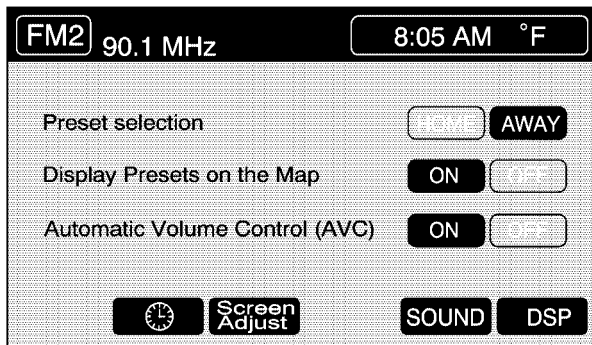

**Preset Selection:** The audio system's presets can be programmed to recall the home settings by touching HOME. The presets used when traveling can also be recalled to another area by touching AWAY. See "Preset Station Menu" later in this section for more information on how to store preset stations.

The Home and Away feature is not available for the XM™ Satellite Radio source, if equipped.

**Display Presets on the Map:** With this feature on, the audio system presets for the current audio source displays on the left of the map screen. Touch ON to turn this feature on. This feature can also be turned off.

With this feature on, the preset radio stations can be recalled from the map screen. Preset stations from the map screen cannot be stored. This must be done from the audio screen. See "Preset Station Menu" later in this section for more information on storing presets.

**Noise Compensation Technology:** The system is equipped with Bose® AudioPilot® noise compensation technology. AudioPilot continuously adjusts the audio system equalization to compensate for the background noise, so the music sounds the same, even as the background noise levels change.

To use AudioPilot®, press the ON screen button. To turn it off, press the OFF screen button.

This feature is most effective at lower volume settings where background noise can affect how well the music being played through the vehicle's audio system is heard. At higher volume settings, where the music is much louder than the background noise, there may be little or no adjustments by AudioPilot®.

For more information on AudioPilot®, visit [bose.com/audiopilot](http://bose.com/audiopilot).

 **(Clock):** Touch this screen button to get to the CLOCK ADJUST menu. See “Clock Adjust Menu” later in this section for more information.

**SCREEN ADJUST:** To adjust the brightness or contrast of the screen, touch SCREEN ADJUST to display the screen adjust menu. See “Screen Adjust Menu” later in this section for more information.

**SOUND:** Touch this screen button to access the Sound menu. See “Sound Menu” later in this section for more information.

**DSP (Digital Signal Processing):** Touch this screen button to access the DSP menu. See “Adjusting the Speakers” later in this section for more information.

## Clock Adjust Menu

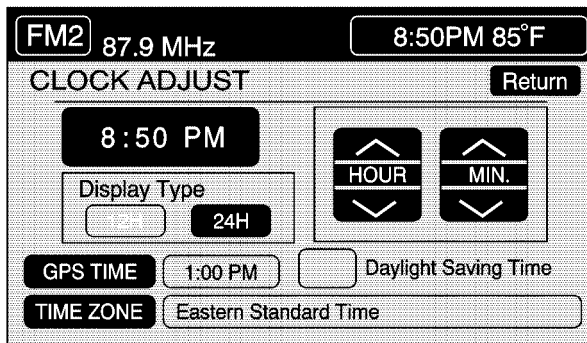

The following options are available from this menu:

**HOUR/MIN.:** Touch the up or down arrows to increase or decrease the hour or minutes. Touch and hold one of the arrows to advance the numbers quickly.

**12H/24H:** Touch 12H to set the clock in standard time or 24H to set the clock in military time.

**GPS TIME:** The current GPS time displays to the right of this screen button. Touch GPS TIME to set the navigation system time to match current GPS time. If the seconds for the present minute are greater than thirty when GPS TIME is selected, the clock rounds up to the next minute.

**Daylight Saving Time:** Touch this screen button to increase the time setting by one hour. Then touch GPS TIME to save the new setting. If the screen button is light blue, the daylight savings time feature is on. If the button is dark blue, the daylight savings time feature is off.

**TIME ZONE:** The selected time zone appears to the right of this screen button. Touch this screen button to toggle between time zones and select the desired one. The time of the selected zone displays to the right of the GPS TIME screen button. To set the clock to the new setting, touch GPS TIME.

If the system is not receiving GPS information, the time can still be set manually as described above but the GPS time and Daylight Saving Time features will not be available.

Touch Return to go back to the previous menu.

## Screen Adjust Menu

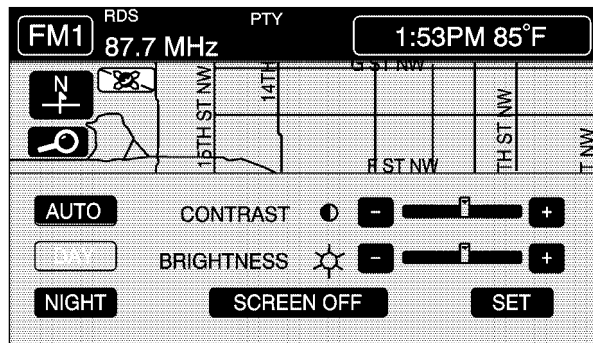

The following options are available from this menu:

**☾ (Contrast):** Touch the plus (+) or minus (-) signs to adjust the contrast of the screen. The screen changes. Touch SET to confirm the setting.

**☀ (Brightness):** Touch the plus (+) or minus (-) signs to adjust the brightness of the screen. The screen changes. Touch SET to confirm the setting.

**AUTO:** This setting automatically adjusts the contrast and brightness of the screen depending on exterior lighting conditions.

**DAY:** This setting leaves the screen in day mode. Day mode is best suited for daylight conditions.

**NIGHT:** This setting leaves the screen in night mode. Night mode is best suited for nighttime conditions.

**SCREEN OFF:** Touch SCREEN OFF to turn off the screen. Press any hard key to turn the screen back on.

**SET:** Touch SET to save the choices and exit the CLOCK ADJUST menu.

## Language

The vehicle has been set for the English language. Change the language, through the Driver Information Center (DIC). See *Driver Information Center (DIC)* on page 3-57 for more information.

If the language is changed from English, a majority of the voice guidance prompts and screen text changes to the selected language. Remember, the menu screens will not match word-for-word as they appear in this manual.

## Playing the Radio

**PWR-VOL (Power-Volume):** Press to turn the audio and navigation systems on and off. Turn the knob to increase or decrease the volume to the audio system.

^ **TUNE/SEEK** v : Press the up or down arrow to go to the next or previous station and stay there.

**BAND:** Press this key to switch between AM, FM1, FM2, XM1, XM 2, or WX, if equipped. While on a map screen and this key is pressed, the screen will not change but the audio source will.

## Finding a Station

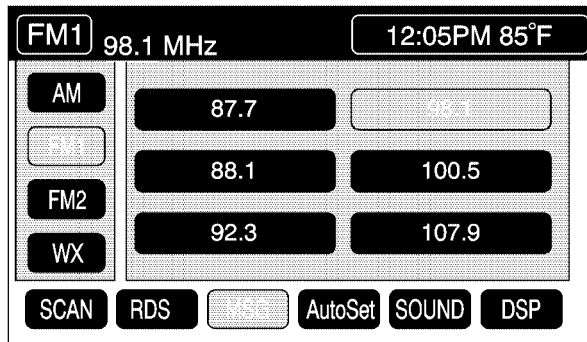

**FM1 audio source shown, other sources similar**

Press the BAND key to switch between AM, FM1, FM2, XM1, XM2, or WX, if equipped. Touch the desired audio source to select it.

## Preset Station Menu

Up to 36 stations, 6 AM, 6 FM 1, 6 FM 2, 6 XM 1, 6 XM 2, and 6 WX, if equipped, can be programmed for home and for away. To store presets:

1. Turn the audio system on.
2. Touch AM, FM, XM, or WX, if equipped, to display the desired source. The preset station menu appears.
3. Tune to the desired station by using the TUNE/SEEK arrows.
4. Touch SOUND to set the bass, mid-range, treble, and DSP for your preset, if desired. See “Sound Menu” later in this section for more information.
5. Touch and hold one of the six numbered preset buttons for more than two seconds until a beep is heard.
6. Repeat the steps for each preset and source.

**SCAN:** To scan stations, touch SCAN. The radio goes to a station, plays for a few seconds, then goes to the next station. Touch SCAN again to stop scanning.

To scan preset stations, touch and hold SCAN for two seconds. It only scans the audio source it is in, with the exception of FM 1 and FM 2, which will both be scanned if in that source. Touch SCAN again to stop scanning.

**RDS (Radio Data System):** See “Radio Data System (RDS)” later in this section for more information.

**MSG (Message):** See “Radio Data System (RDS)” later in this section for more information.

**AutoSet:** Touch AutoSet to replace currently stored preset stations with the strongest stations available in the immediate area. Touch AutoSet again to return to the original preset stations.

**SOUND:** See “Sound Menu” following for more information.

**DSP:** See “Adjusting the Speakers” later in this section for more information.

## Sound Menu

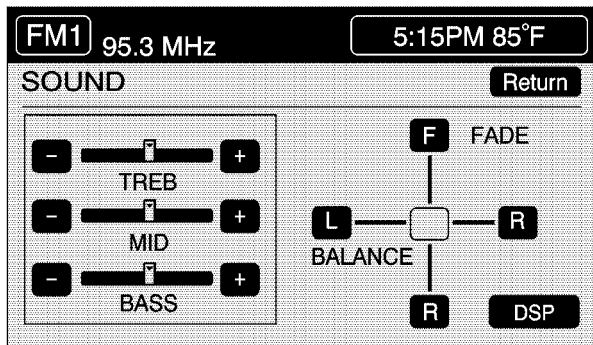

Touch SOUND at the bottom of the main audio screen, source menu, or DSP menu to change the tone, DSP, if equipped, fade, and balance for all sources. The audio system has a separate setting for these features for each source preset. However, the audio system keeps one fade and one balance setting for all audio sources.

To adjust sound settings:

1. Touch the plus (+) or minus (-) signs to adjust treble, mid-range, and bass.
2. Touch the L for left or R for right to adjust the balance of the speakers.

3. Touch the F for front or R for rear to adjust the fade of the speakers.
4. Touch DSP to adjust the DSP, if equipped. See "Adjusting the Speakers" later in this section for more information.

After adjustments are made, touch any source screen button. This takes you back to the preset station menu. Whenever that screen button is touched, the previously stored information that was entered for each preset station is recalled.

To adjust the tone for each preset:

1. Press the BAND key.
2. Touch AM, FM1, FM2, XM1, XM2, or WX, if equipped, to access the desired preset screen.
3. Touch SOUND.
4. Touch the plus (+) or minus (-) signs to adjust treble, mid-range, and bass.
5. Touch Return to exit. This takes you to the preset station menu.
6. Touch and hold one of the six preset screen buttons for more than two seconds until a beep is heard. Whenever that preset is touched for less than two seconds, the station and previously stored information that was entered for each preset station is recalled.
7. Repeat the steps for additional presets.



## Adjusting the Speakers

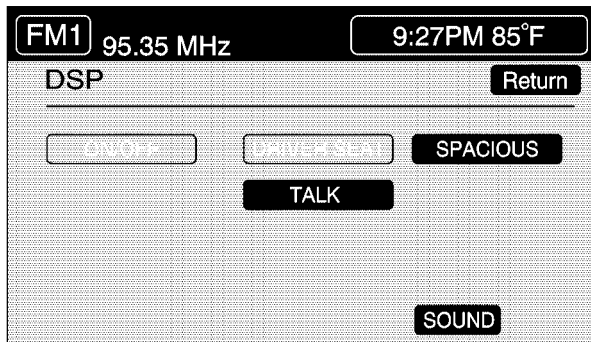

**DSP (Digital Signal Processing):** The DSP feature is used to provide a choice of four different listening experiences. DSP can be used while listening to the audio system or the CD player. The audio system can store separate DSP settings for each source and preset station, except WX, which is always set to TALK.

To save DSP settings for the preset stations, use the SOUND menu or touch DSP from the preset station menu to access the DSP menu. See “Sound Menu” listed previously in this section for more information.

Touch DSP to change the following options:

**ON/OFF:** Touch to turn DSP on and off.

**DRIVER SEAT:** Touch to adjust the audio to give the driver the best possible sound quality.

**TALK:** TALK makes spoken words sound very clear. Touch this button when listening to non-musical material such as news, talk shows, and sports broadcasts.

**SPACIOUS:** Touch to make the listening space seem larger.

**SOUND:** Touch to access the Sound menu. See “Sound Menu” listed previously in this section for more information.

## Radio Data Systems (RDS)

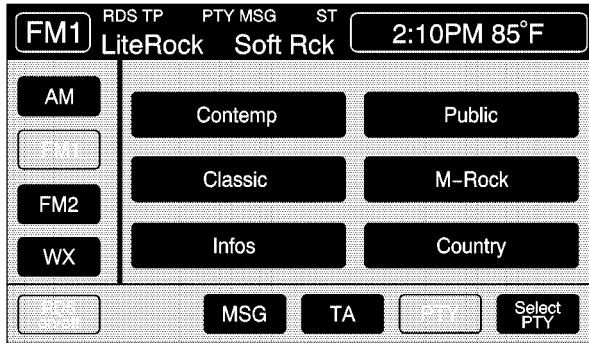

The audio system has a Radio Data System (RDS). RDS features are available for use only on FM stations that broadcast RDS information. With RDS, the radio can:

- Seek to stations broadcasting the selected type of programming
- Receive announcements concerning local and national emergencies
- Display messages from radio stations
- Seek to stations with traffic announcements

**RDS:** Touch RDS to use alternate RDS functions located in the preset menu. After touching RDS, there is about five seconds to choose RDS ON/OFF, TA, MSG, PTY, or SEL PTY. If no selection is made, the system returns to the previous menu.

If tuned to a station broadcasting RDS information, the station's Program Service (PS) and Program Type (PTY) will replace the station's frequency on the status line at the top of the display. After about five seconds, if available, the PTY will be replaced on the display by the station's PTY name. The PTY and PTY name may be the same or different.

If the audio system is tuned to a station that is not broadcasting RDS information, the station's frequency remains on the display. While RDS is on, the audio system searches for a stronger station in the network if a station gets too weak for listening.

The RDS feature relies upon receiving specific information from RDS stations. These features only works when RDS information is available.

**TA (Traffic):** Touch TA to receive traffic announcements. The audio system turns on the TA display. TA appears on the display if the current station broadcasts traffic announcements. Traffic announcements can also be received from stations in the network related to the

current station. If the current station does not broadcast traffic announcements, the audio system seeks to a station which will. When the audio system finds a station which broadcasts traffic announcements, it will stop. If no station is found, TA will turn off.

While a traffic announcement plays, the audio system uses TA volume. To increase TA volume, touch the VOL button on the steering wheel or use the VOL up or down buttons during the announcement. See “Voice Guidance Volume Settings” under *Setup Menu on page 4-12* for more information.

When a traffic announcement comes on the current radio station or a related network station, it will be heard even if the volume is muted or a CD is playing. If the audio system tunes to a related network station for a traffic announcement, it returns to the original station when the announcement is finished. If the CD player was being used, the CD will stay in the player and resume play at the point where it stopped.

Touch RDS followed by TA again to turn TA off.

**SG (Message):** When RDS is on, if the current station has a message, MSG displays. Touch MSG from the preset menu to view the message. If the whole message does not appear on the display, parts of the message appears every three seconds until the message is

completed. Once the complete message has been displayed, MSG disappears from the display until another new message is received. MSG remains available allowing the entire message to be displayed again.

**PTY:** PTY seeks only to stations with desired types of programming. This button is used to turn on and off Program Type (PTY) features.

With RDS on, touch RDS, followed by PTY. The PTY display turns on. Touch RDS followed by this button again to turn the PTY display off.

**Select PTY (Select Program Type):** With RDS and PTY on, touch RDS, then SEL PTY. The PTY menu appears. Use the up and down arrows to select a PTY. Touch the PTY selection and the system returns to the screen with the preset stations shown. See Steps 1 through 7 under “Preset Station Menu” to store the selected PTYs. The selected PTY is then stored on the preset. Touch the PTY preset to recall your settings.

When the PTY display is on, press TUNE/SEEK and SCAN to find radio stations of the PTY selected. The last PTY selected is used for seek and scan modes. If a station with the selected PTY is not found, NONE FOUND appears on the display. If both PTY and TA are on, the audio system searches for stations with traffic announcements and the selected PTY.

**PTY (Program Type) Presets:** The six presets let you return to favorite PTYs. These presets have factory PTY preset stations. See “RDS Program Type (PTY) Selections” later in this section. Up to 12 PTYs, 6 FM 1 and 6 FM2 can be set. To save a PTY preset:

1. Touch FM1 or FM2.
2. Touch RDS to enter the RDS menu.
3. Touch RDS ON/OFF to turn RDS on.
4. Touch PTY.
5. Touch SEL PTY and select the desired PTY from the list.
6. Touch and hold one of the six presets for more than two seconds until a beep is heard. Whenever that numbered preset is touched for less than two seconds, the PTY that was set, returns.
7. Repeat the steps for each preset.

Once a PTY is stored for each of the preset stations, a PTY preset can be recalled by touching the preset station for less than two seconds. Then use TUNE/SEEK or SCAN to locate a station for that PTY selection.

**ALERT:** This type of announcement warns of national or local emergencies. Alert announcements cannot be turned off. Alert announcements come on even if RDS mode is turned off. ALERT appears on the display when an alert announcement plays. The audio system uses TA volume during these announcements. To increase volume, touch the VOL button on the steering wheel or use the VOL up and down buttons during the announcement. See “Voice Guidance Volume Settings” under *Setup Menu on page 4-12* for more information. When an alert announcement comes on the tuned radio station or a related network station, it will be heard even if the volume is muted or a CD is playing. If the audio system tunes to a related network station for an alert announcement, it returns to the original station when the announcement is finished. If the CD player is playing, the player stops for the announcement and resume when the announcement is finished.

## XM™ Satellite Radio Service

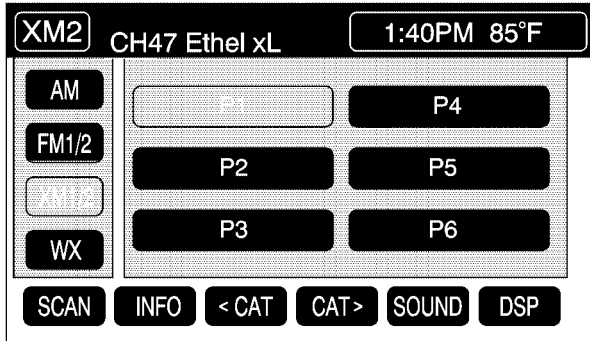

XM™ is a satellite radio service that is based in the 48 contiguous United States and 10 Canadian provinces. XM Satellite Radio has a wide variety of programming and commercial-free music, coast-to-coast, and in digital-quality sound. During your trial or when you subscribe, you will get unlimited access to XM Radio Online for when you are not in the vehicle. A service fee is required to receive the XM service.

For more information, contact XM at [xmradio.com](http://xmradio.com) or call 1-800-929-2100 in the U.S. and [xmradio.ca](http://xmradio.ca) or call 1-877-438-9677 in Canada.

**INFO (Information):** Touch INFO while in XM™ mode to retrieve various pieces of information related to the current song or channel. By touching INFO, four different types of information can be retrieved: Artist, Song Title, Channel, and Category. Additional information may also be broadcast on that channel. Additional Information messages may only be available at certain times or on certain programs. If an Additional Information message is being broadcast on the tuned channel, INFO displays.

Each of the four information types may have multiple pages of text. To reach a category, touch INFO repeatedly until the desired type is displayed. If there are multiple pages of text for the information selected type, the radio automatically displays all the pages for that type at a rate of about one page every three seconds before timing out and returning to the default display. This feature can be overridden by touching INFO to review all of the pages at your own pace.

## Setting Program Type (PTY) Preset Stations

**< CAT > (Category):** Press the arrows to select a category.

Once the desired category is displayed, press TUNE/SEEK to select the category and go to the category's first station. To go to another station within that category, press TUNE/SEEK once.

Touch and hold one of the desired P1-P6 presets to store the selected station as a preset. If PTY times out and is no longer on the display, start again.

**SCAN:** Use this button to scan through the channels within a category or scan through the preset stations.

To scan through the channels in a category:

1. Select a category by using the category arrows.
2. Once the desired category is displayed, touch SCAN. The radio begins scanning within the chosen category.
3. Touch SCAN again to stop scanning.

To scan through preset stations, touch and hold SCAN. Touch SCAN again to stop scanning.

## XM™ Radio Messages

**XL (Explicit Language Channels):** XL on the radio display, after the channel name, indicates content with explicit language. These channels, or any others, can be blocked at a customer's request by calling 1-800-852-XXXM (9696).

**XM Updating:** The encryption code in the receiver is being updated and no action is required.

**No XM signal:** The vehicle is in a location that is blocking the XM™ signal. When the vehicle is moved into an open area, the signal should return.

**Loading XM:** The audio system is processing audio and text data received. No action is needed.

**Channel Off Air:** This channel is not currently in service.

**Channel Unauth:** This channel is blocked or cannot be received with the XM™ subscription package.

**Channel Unavail:** This previously assigned channel is no longer assigned.

**No Artist Info:** No artist information is available. The system is working properly.

**No Title Info:** No song title information is available. The system is working properly.

**No CAT Info:** No category information is available. The system is working properly.

**CAT Not Found:** There are no channels available for the selected category. The system is working properly.

**No Information:** No text or informational messages are available. The system is working properly.

**XM Theftlocked:** The XM™ receiver may have previously been in another vehicle. For security purposes, XM™ receivers cannot be swapped between vehicles. If this message is received after having your vehicle serviced, check with your dealer/retailer.

**XM Radio ID:** If tuned to channel 0, this message will alternate with the XM™ Radio eight digit radio ID label. This label is needed to activate the service.

**Unknown:** If this message is received when tuned to channel 0, there may be a receiver fault. Consult with your dealer/retailer.

**Check XM Receiver:** If this message does not clear within a short period of time, the receiver may have a fault. Consult with your dealer/retailer.

**XM Not Available:** If this message does not clear within a short period of time, the receiver could have a fault. Consult with your dealer/retailer.

## Six-Disc CD Changer

With the compact disc changer, up to six normal size discs can be played continuously.

When the radio is turned on, the changer begins checking for discs. This continues for up to one and a half minutes, depending on the number of discs loaded. Noise might be heard, but this is normal. The CD changer is initializing.

Press the CD hard key to access the six-disc CD changer screen. You can also use the system's DVD player for single CD play once the map DVD is removed. See *CD/DVD Player on page 4-68* for more information.

If no CD is loaded in the CD/DVD Player and the CD hard key is pressed, the message "No CD Loaded" displays.

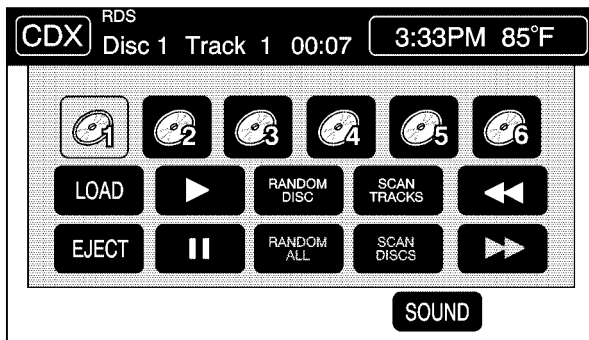

### CD Changer Screen

Once the CD changer screen is accessed, you can select one of the numbered buttons to go from one compact disc to another among those loaded in the CD changer and use the arrows to rewind or fast forward through the disc selected.

The following features are also available from this screen:

- LOAD
- EJECT
- SCAN THE DISCS or SCAN THE TRACKS
- and RANDOM ALL or RANDOM DISC.

The numbered buttons (1 through 6) represent the order of the discs loaded in the changer. If there are only two CDs loaded, buttons 1 and 2 will only be available to choose from.

**LOAD:** Touch once each time a CD is loaded into the changer. It may take up to 10 seconds for the changer to accept the CD into the slot depending on the changer initializing. Repeat this procedure for loading up to six discs. Press and hold the LOAD button until a beep is heard to put the changer in LOAD ALL mode. Once the Insert CD message is displayed, you can load all six discs, one after the other.

▶ **(Play):** Touch to begin playing a CD.

**RANDOM DISC:** Touch to hear the tracks in random, rather than sequential, order on the disc selected. Press the TUNE/SEEK hard key to randomly seek through the tracks on this disc. Touch RANDOM DISC again to turn off random play mode.

**SCAN TRACKS:** Touch to hear the first 10 seconds of each track on the selected disc. Touch this button again to stop scanning. The CD mutes while scanning.

◀◀ **(Rewind):** Touch to rewind quickly through a track selection.



**EJECT:** Touch once to eject the chosen CD. The chosen CD may be selected by first touching one of the numbered buttons from 1 to 6. Repeat this procedure for ejecting up to six discs from the changer. If the EJECT button is pressed and held until a beep is heard, the system begins to eject all of the discs from the player. Once the CD is removed the next will come out until they are all ejected.

**|| (Pause):** Touch to pause CD play. Touch it again to resume play or touch the play button.

**RANDOM ALL:** Touch to hear the tracks on all of the discs in the CD changer in random, rather than sequential, order. Press the TUNE/SEEK hard key while RANDOM ALL is on to randomly seek within that disc. Touch RANDOM ALL again to turn off random mode.

**SCAN DISCS:** Touch to hear the first 10 seconds of first track on each disc. Touch this button again to stop scanning. The CD mutes while scanning.

**▶▶ (Forward):** Touch to fast forward quickly through a track selection.

**∧ TUNE SEEK ∨ :** Press the up arrow on the TUNE/SEEK switch to seek to the next selection on the compact disc. If playing last track of disc, pressing the up arrow seeks to the first track of the next disc.

Press the down arrow to seek to the previous selection on the compact disc. If playing the first track of disc, pressing the down arrow seeks to the last track on the selected disc. The sound mutes while seeking.

**RDS (Radio Data Systems):** See “Radio Data Systems (RDS)” listed previously for information on this button.

**SOUND:** See “Sound Menu (Tone, DSP, Fade and Balance)” for information on this button.

**DSP (Digital Signal Processing):** See “Adjusting the Speakers” listed previously for information on this button.

## CD Changer Errors

CDX ERROR could be displayed for the following:

- The road is too rough. The disc should play when the road is smoother.
- The disc is dirty, scratched, wet or not loaded label side up.
- The air is very humid. If so, wait about an hour and try again.

If any error occurs repeatedly or if an error cannot be corrected, please contact your dealer/retailer. If the audio system displays an error number, write it down and provide this information to your dealer/retailer when reporting the error.

## CD/DVD Player

The player that is used for the navigation map DVD can also be used as a single music CD player or a video DVD player.

## CD Player

To use the player as a single music CD player, the navigation map DVD must be removed. While playing a CD in the CD/DVD Player, the navigation system is not available. The message "The disc installed is not a map DVD" will appear on the display if any of the navigation hard keys are pressed.

To remove the navigation map DVD and load a music CD:

1. Start the vehicle.
2. Press the TILT hard key until you hear a beep. This opens the faceplate of the system.

3. If one is loaded, the navigation map DVD ejects from the slot.
4. Gently remove the navigation map DVD from the slot and return it to its case.
5. Insert the music CD into the slot. The system pulls the CD into the player.
6. Press and release the TILT hard key to close the faceplate.

**Notice:** Shifting out of P (Park) with the system's faceplate open will cause the faceplate to close automatically. This could cause damage to a CD, DVD or the system if it is partially loaded. Before shifting out of P (Park), make sure that the DVD or CD is loaded properly. The vehicle must be shifted back into P (Park) to close the faceplate.

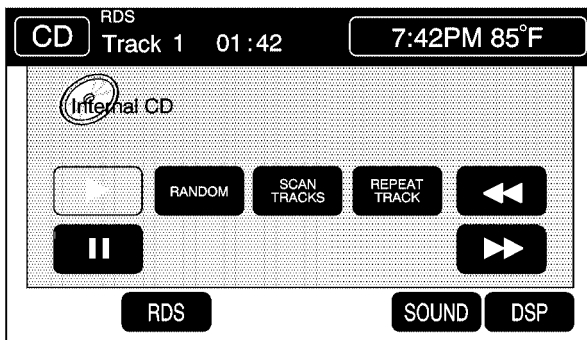

**CD Player Screen**

Once a music CD is loaded, the CD player menu appears on the display. When using the system as a single CD player, the CD hard key will alternate between the CD player and the six-disc CD changer if CDs are loaded.

▶ **(Play):** Touch to begin playing a CD.

**RANDOM:** Touch to hear the tracks in random, rather than sequential, order on the disc. Touch RANDOM again to turn off random mode.

**SCAN TRACKS:** Touch to hear the first 10 seconds of each track on the disc. Touch this button again to stop scanning. The CD will mute while scanning.

**REPEAT TRACK:** Touch to repeat the selected track.

◀◀ **(Rewind):** Touch to rewind quickly through a track selection.

|| **(Pause):** Touch to pause CD play. Touch it again to resume play or touch the play button.

▶▶ **(Forward):** Touch to fast forward quickly through a track selection.

^ **TUNE SEEK** v : Touch the up arrow on the TUNE/SEEK hard key to seek to the next selection on the compact disc. If playing the last track of the disc, touching the up arrow will seek to the first track of the disc. Touch the down arrow to seek to the previous selection on the compact disc. If playing the first track of the disc, touching the down arrow seeks to the last track of the disc. The sound mutes while seeking.

## DVD Player

To use the player as a video DVD player, first remove the navigation map DVD or music CD. While playing a video DVD, the navigation system is not available. The message “The disc installed is not a map DVD” appears on the display if any of the navigation hard keys are pressed.

This feature will not operate unless the vehicle is in P (Park).

To remove the navigation map DVD and load a video DVD:

1. With the vehicle in P (Park) and the vehicle running, press the TILT hard key until a beep is heard. The faceplate of the system will open.
2. If a map DVD or a music CD is loaded, the system automatically ejects it. Gently remove it from the slot and return it to its case.
3. Load the video DVD into the slot. The system pulls the DVD into the player.
4. Press and release the TILT hard key to close the faceplate.

**Notice:** Shifting out of P (Park) with the system’s faceplate open will cause the faceplate to close automatically. This could cause damage to a CD, DVD or the system if it is partially loaded. Before shifting out of P (Park), make sure that the DVD or CD is loaded properly. The vehicle must be shifted back into P (Park) to close the faceplate.

Once the faceplate is closed and a video DVD is loaded, the system automatically plays the DVD.

## Playing a DVD

There are two ways to play a DVD depending on which screen is displayed:

- From a map screen, touch the DVD source button.
- From the audio screen, press the DVD hard key.

Once a DVD is inserted, the system automatically plays the DVD.

## DVD Menu Options

To display the menu choices while a DVD is playing, touch anywhere on the screen and the menu appears.

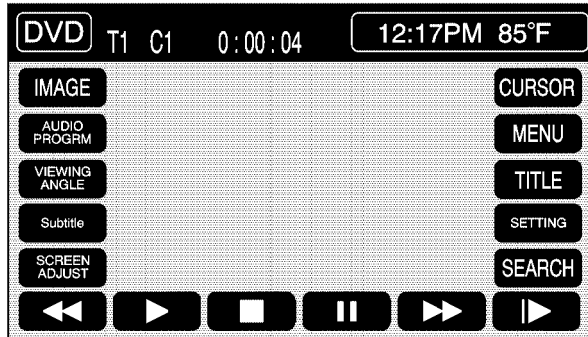

**IMAGE:** Touch to either start playing a DVD or to remove the DVD menu screen.

**AUDIO PROGRAM:** Touch to change the audio language heard.

**VIEWING ANGLE:** Touch to adjust the viewing angle of the DVD. Some DVDs allow you to change the camera angle. This may not be available on all DVDs. Depending on the type of DVD being used, this button may or may not be available.

**SUBTITLE:** Touch to playback the video with subtitles. This may not be available on all DVDs. Depending on the type of DVD being used, this button may or may not be available.

**SCREEN ADJUST:** Touch to adjust the brightness, contrast and red/green color adjustments.

**CURSOR:** Touch to access the left/right and up/down cursors on the screen. The cursors allow menu options to be navigated on the screen.

**MENU:** Touch to access the DVD's menu options. Depending on the type of DVD being used, this button may or may not be available. Touch the button labeled one, two or blank to change the image size displayed on the screen.

**TITLE:** Touch this button to display the title of the DVD. Depending on the type of DVD being used, this button may or may not be available.

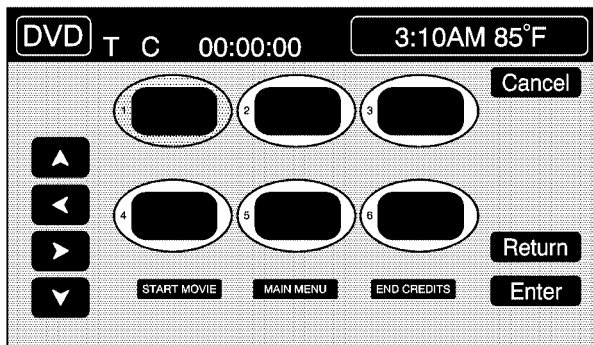

If TITLE is available, this button allows navigation through chapters or the DVD features. Once the appropriate title or track has been selected, press the Return button then the IMAGE button on the DVD menu to view the movie in full screen.

**SETTING:** Touch to adjust the following:

- LANGUAGE PREFERENCES
- PARENTAL LOCK

Under LANGUAGE PREFERENCES, you can select different languages for AUDIO, SUBTITLE and DVD MENU.

1. To change languages, first select the option to be changed.
2. Select a language from the list given.
3. Touch RETURN to end out the menu. The selected language is now saved.

Under PARENTAL LOCK, select SET RATING LIMIT and SET PIN.

To SET RATING, first touch the button. Then, make the selection. Touch RETURN to end out the menu. The selection is now saved.

To use PARENTAL LOCK, first touch the button. Then, enter a four-digit numeric password. Touch RETURN to end out the menu.

**SEARCH:** Touch to search to a certain scene on the DVD. Depending on the type of DVD being used, this button may or may not be available.

◀◀ **(Rewind):** Touch to rewind through a scene during playback.

▶ **(Resume):** Touch to resume playing a DVD.

■ **(Stop):** Touch to stop the DVD.

|| **(Pause):** Touch to pause the DVD.

▶▶ **(Forward):** Touch to advance rapidly during playback.

▶ **(Frame Advance):** Touch to advance by chapter during playback.

## Radio Personalization with Home and Away Feature

With this feature, the latest audio system settings can be recalled that were adjusted the last time the vehicle was operated. This feature allows two different drivers to store and recall their own audio system settings. The settings recalled by the audio system are determined by which transmitter (1 or 2) was used to enter the vehicle.

The number on the back of the transmitter corresponds to driver 1 or to driver 2. The audio system settings will automatically adjust to where they were last set by the identified driver. The settings can also be recalled by briefly pressing the MEMORY seat switches 1 or 2 located on the driver door.

The audio system can store HOME and AWAY preset stations. HOME and AWAY preset stations allow use of one set of preset radio settings in the area where you live, and another set when you go out of town. That way, there is no need to reprogram the preset stations every time you travel.

To select HOME and AWAY preset stations:

1. With the audio system on, touch the Audio hard key and turn the audio system off.
2. Touch the HOME or AWAY button from the main audio screen.

The next time the audio system is turned on, the system recalls the last active preset selection.

When battery power is removed and later applied, the home audio system preset stations do not have to be reset because the audio system remembers them. However, the away radio preset stations have to be reset.

# Voice Recognition

The navigation system's voice recognition allows for hands-free operation of navigation and audio system features. Voice recognition can be used when the ignition is on or when Retained Accessory Power (RAP) is active.

This feature only works if the map DVD is inserted and I AGREE has been selected. If voice recognition is used without the map DVD inserted, the system displays "Please insert the navigation map DVD to use the voice recognition feature." See "Installing the DVD Map Disc" under *Maps on page 4-38*.

To use navigation voice recognition:



1. Push and hold the talk symbol steering wheel control until a beep is heard. The audio system mutes.

2. Clearly state one of the commands listed on the following pages. For example, say "FM1".
3. The system states the command being implemented. For example, the system says "FM1 Radio" and change the audio system to the FM1 source.

The voice recognition can be ended by not speaking any commands. After about five seconds of silence, the system automatically cancels voice recognition.

At times, the system may not understand a spoken command. If this happens, try saying the command again. If a spoken command is not available, the system provides feedback based on availability.

While using voice recognition, make sure to keep interior noise levels to a minimum. Otherwise, the system might not recognize voice commands.

The system only recognizes commands spoken in English.



## Voice Recognition Commands

The following list shows all of the voice commands available for the navigation system with a brief description of each. To use the voice commands, refer to the instructions listed previously.

### Help Commands

These commands are universal and will enable use of the help prompts available from the system.

**Map Help:** Provides the available commands for the map screen.

**Destination Help:** Provides the available commands for entering a destination.

**Guidance Help:** Provides the available commands for the guidance method.

**Radio Help:** Provides the available commands for the radio.

**Disc Help:** Provides the available commands for the CD changer.

## Radio Commands

**Radio:** Changes the audio system to the next radio audio source.

**AM:** Changes the audio system to the AM audio source.

**FM1:** Changes the audio system to the FM1 audio source.

**FM2:** Changes the audio system to the FM2 audio source.

**XM1:** Changes the audio system to the XM1 audio source.

**XM2:** Changes the audio system to the XM2 audio source.

**CD Changer:** Changes the audio system to the CD changer audio source.

**WX, Weather Band:** Changes the audio system to the weather band audio source.

**Power On, Audio On:** Turns the system's power on.

**Power Off, Audio Off:** Turns the system's power off.

**Seek Up:** Causes the selected audio source to seek up to the next strongest signal.

**Seek Down:** Causes the selected audio source to seek down to the next strongest signal.

**Stop Scan:** Causes the audio source to stop scanning for the next strongest signal.

## CD Changer Commands

**Track Up:** Causes the CD changer to skip up to the next track.

**Previous Track, Track Down:** Causes the CD changer to go to the previous track.

## Screen Commands

**Screen Day Mode, Day Mode On:** Adjusts the system's screen setting to the day mode.

**Screen Night Mode, Night Mode On:** Adjusts the system's screen setting to the night mode.

**Screen Auto Mode, Auto Mode On:** Adjusts the system's screen setting to auto mode.

**Screen Off:** Turns the system's screen display off.

## Position Commands

**Current Position, Current Location, Show Current Position, Show Current Location:** Displays the vehicle's current location on the map screen.

**Map:** Displays the map screen.

## Map Commands

**Zoom In:** Zooms in when on the map screen.

**Zoom Out:** Zooms out when on the map screen.

**Maximum Scale:** Zooms out to the maximum available map scale when on the map screen.

**Minimum Scale:** Zooms in to the minimum available map scale when on the map screen.

**Heading Up, Change to Heading Up:** Displays the Vehicle Up heading when on the map screen. The map scale should be set for under 2 miles (4 km).

**North Up, Change to North Up:** Displays the North Up heading when on the map screen if the map scale is set to 2 miles (4 km) or less.

**Map Direction, Change Map Direction:** Changes the vehicle's direction from North Up to Heading Up or Heading Up to North Up on the map screen if the map scale is set to 2 miles (4 km) or less.

**Mark, Mark This Point:** Marks the location as a memory point while on the map screen.

## Destination Commands

**Home, Go Home:** Enters the Home destination, if one is set.

**Go To Starting Point, Previous Starting Point:** Enters the last available starting point as a destination.

## Guidance Commands

**Repeat Guidance, Repeat Voice:** Repeats the last available voice prompt guidance command if a destination has been set.

**Louder:** Increases the volume of the navigation voice prompts if a destination has been set.

**Softer:** Decreases the volume of the navigation voice prompts if a destination has been set.

**Voice Guidance Off:** Turns off the navigation voice prompts if a destination has been set.

**Voice Guidance On:** Turns on the navigation voice prompts if a destination has been set.

**Open Guidance, Open Guidance Screen, Open Guide, Open Guide Screen:** Opens the Guidance Appearance menu if a destination has been set.

**Close Guidance, Close Guidance Screen, Close Guide, Close Guide Screen:** Closes the Guidance Appearance menu if a destination has been set.

**Arrow Guidance, Arrow Guide, Change To Arrow Guidance, Change To Arrow Guide:** Changes to Arrow Guidance screen view in the Guidance Menu if a destination has been set.

**Turn List Guidance, Turn List Guide, Change to Turn List Guidance, Change to Turn List Guide:** Changes to Turn List Guidance screen view in the Guidance Menu if a destination has been set.

**Entire Route, Entire Route Map, Route Overview:** Displays the entire route if a destination has been set.

**Reroute:** Generates an alternate route to a set destination while on a planned route.

**Detour, Detour Entire Route:** Activates the detour feature when driving a planned route.

**Delete Destination, Cancel Destination:** Cancels a destination if one has been set.

**Next Waypoint Map:** Displays the map view of the next waypoint location if one has been set.

**First Waypoint Map:** Displays the map view of the first waypoint location if one has been set.

**Second Waypoint Map:** Displays the map view of the second waypoint location if more than one waypoint has been set.

**Third Waypoint Map:** Displays the map view of the third waypoint location if more than two waypoints have been set.

**Fourth Waypoint Map:** Displays the map view of the fourth waypoint location if more than three waypoints have been set.

**Fifth Waypoint Map:** Displays the map view of the fifth waypoint location if more than four waypoints have been set.

**Destination Map:** Displays the map view of the final destination location if one has been set.

## Point of Interest (POI) Commands

The following commands cause the system to display icons if they are available on the map screen when the map scale is set to a half mile (eight-tenths km) or less.

**Restaurant, I'm Hungry:** Displays restaurant POI icons.

**American Restaurant, American Food:** Displays American restaurant POI icons.

**Chinese Restaurant, Chinese Food:** Displays Chinese restaurant POI icons.

**Continental Restaurant, Continental Food:** Displays Continental restaurant POI icons.

**French Restaurant, French Food:** Displays French restaurant POI icons.

**Italian Restaurant, Italian Food:** Displays Italian restaurant POI icons.

**Japanese Restaurant, Japanese Food:** Displays Japanese restaurant POI icons.

**Mexican Restaurant, Mexican Food:** Displays Mexican restaurant POI icons.

**Seafood Restaurant, Seafood:** Displays Seafood restaurant POI icons.

**Other Restaurant, Other Food:** Displays other types of restaurant POI icons.

**Shopping, Shopping Mall:** Displays mall POI icons.

**Grocery Store:** Displays grocery store POI icons.

**Gas Station, Gas:** Displays gas station POI icons.

**Parking Garage:** Displays parking garage POI icons.

**Parking Lot:** Displays parking lot POI icons.

**Rental Car Agency:** Displays rental car POI icons.

**Automobile Club, Triple A:** Displays auto club POI icons.

**Auto Service And Maintenance, Auto Service, Maintenance:** Displays auto service POI icons.

**Hotel:** Displays hotel POI icons.

**Golf Course:** Displays golf course POI icons.

**Ski Resort, Skiing:** Displays ski resort POI icons.

**Amusement Park:** Displays amusement park POI icons.

**Sport Complex, Stadium:** Displays sports complex POI icons.

**Casino:** Displays casino POI icons.

**Marina:** Displays marina POI icons.

**Tourist Attraction:** Displays tourist attraction POI icons.

**Winery:** Displays winery POI icons.

**City Hall:** Displays city hall POI icons.

**Police Station:** Displays police station POI icons.

**Library:** Displays library POI icons.

**Hospital:** Displays hospital POI icons.

**Park & Recreation, Parks & Recreation:** Displays parks and recreation POI icons.

**Civic Center, Community Center:** Displays community center POI icons.

**Convention Center, Exhibition Center:** Displays convention center POI icons.

**Court House:** Displays court house POI icons.

**Train Station:** Displays train station POI icons.

**Airport:** Displays airport POI icons.

**Bus Station:** Displays bus station POI icons.

**Commuter Rail Station:** Displays commuter rail station POI icons.

**Ferry Terminal:** Displays ferry terminal POI icons.

**Park & Ride:** Displays park & ride POI icons.

**Rest Area, Rest Stop:** Displays rest area POI icons.

**Tourist Information:** Displays tourist information POI icons.

**Historical Monument:** Displays historical monument POI icons.

**Performing Arts:** Displays performing arts POI icons.

**Museum:** Displays museum POI icons.

**Bank:** Displays bank POI icons.

**School:** Displays school POI icons.

**ATM:** Displays ATM POI icons.

**Higher Education, University, College:** Displays higher education POI icons.

**Business Facility:** Displays business facility POI icons.

**City Center:** Displays city center POI icons.

**POI Off:** Turns off POIs so they do not appear on the map screen.

## Section 5 Driving Your Vehicle

---

<b>Your Driving, the Road, and the Vehicle</b> .....	5-2	Driving at Night .....	5-14
Defensive Driving .....	5-2	Driving in Rain and on Wet Roads .....	5-15
Drunk Driving .....	5-2	Before Leaving on a Long Trip .....	5-16
Control of a Vehicle .....	5-3	Highway Hypnosis .....	5-16
Braking .....	5-4	Hill and Mountain Roads .....	5-17
Antilock Brake System (ABS) .....	5-5	Winter Driving .....	5-18
Braking in Emergencies .....	5-6	If Your Vehicle is Stuck in Sand, Mud, Ice, or Snow .....	5-20
StabiliTrak® System .....	5-6	Rocking Your Vehicle to Get It Out .....	5-20
Traction Control System (TCS) .....	5-8	Loading the Vehicle .....	5-21
Magnetic Ride Control™ .....	5-10	<b>Towing</b> .....	5-26
Limited-Slip Rear Axle .....	5-10	Towing Your Vehicle .....	5-26
Steering .....	5-10	Recreational Vehicle Towing .....	5-26
Off-Road Recovery .....	5-12	Towing a Trailer .....	5-26
Passing .....	5-12		
Loss of Control .....	5-12		
Racing or Other Competitive Driving (XLR-V) .....	5-14		

# Your Driving, the Road, and the Vehicle

## Defensive Driving

Defensive driving means “always expect the unexpected.” The first step in driving defensively is to wear your safety belt — See *Safety Belts: They Are for Everyone* on page 1-6.

### CAUTION:

Assume that other road users (pedestrians, bicyclists, and other drivers) are going to be careless and make mistakes. Anticipate what they might do and be ready. In addition:

- Allow enough following distance between you and the driver in front of you.
- Focus on the task of driving.

Driver distraction can cause collisions resulting in injury or possible death. These simple defensive driving techniques could save your life.

## Drunk Driving

### CAUTION:

Drinking and then driving is very dangerous. Your reflexes, perceptions, attentiveness, and judgment can be affected by even a small amount of alcohol. You can have a serious — or even fatal — collision if you drive after drinking. Do not drink and drive or ride with a driver who has been drinking. Ride home in a cab; or if you are with a group, designate a driver who will not drink.

Death and injury associated with drinking and driving is a global tragedy.

Alcohol affects four things that anyone needs to drive a vehicle: judgment, muscular coordination, vision, and attentiveness.



Police records show that almost 40 percent of all motor vehicle-related deaths involve alcohol. In most cases, these deaths are the result of someone who was drinking and driving. In recent years, more than 17,000 annual motor vehicle-related deaths have been associated with the use of alcohol, with about 250,000 people injured.

For persons under 21, it is against the law in every U.S. state to drink alcohol. There are good medical, psychological, and developmental reasons for these laws.

The obvious way to eliminate the leading highway safety problem is for people never to drink alcohol and then drive.

Medical research shows that alcohol in a person's system can make crash injuries worse, especially injuries to the brain, spinal cord, or heart. This means

that when anyone who has been drinking — driver or passenger — is in a crash, that person's chance of being killed or permanently disabled is higher than if the person had not been drinking.

## Control of a Vehicle

The following three systems help to control your vehicle while driving — brakes, steering, and accelerator. At times, as when driving on snow or ice, it is easy to ask more of those control systems than the tires and road can provide. Meaning, you can lose control of your vehicle. See *Traction Control System (TCS)* on page 5-8 and *StabiliTrak® System* on page 5-6.

Adding non-dealer/non-retailer accessories can affect your vehicle's performance. See *Accessories and Modifications* on page 6-3.

## Braking

See *Brake System Warning Light on page 3-47*.

Braking action involves perception time and reaction time. First, you have to decide to push on the brake pedal. That is perception time. Then you have to bring up your foot and do it. That is reaction time.

Average reaction time is about three-fourths of a second. But that is only an average. It might be less with one driver and as long as two or three seconds or more with another. Age, physical condition, alertness, coordination, and eyesight all play a part. So do alcohol, drugs, and frustration. But even in three-fourths of a second, a vehicle moving at 60 mph (100 km/h) travels 66 feet (20 m). That could be a lot of distance in an emergency, so keeping enough space between your vehicle and others is important.

And, of course, actual stopping distances vary greatly with the surface of the road, whether it is pavement or gravel; the condition of the road, whether it is wet, dry, or icy; tire tread; the condition of the brakes; the weight of the vehicle; and the amount of brake force applied.

Avoid needless heavy braking. Some people drive in spurts — heavy acceleration followed by heavy braking — rather than keeping pace with traffic. This is a mistake. The brakes might not have time to cool between hard stops. The brakes will wear out much faster if you do a lot of heavy braking. If you keep pace with the traffic and allow realistic following distances, you will eliminate a lot of unnecessary braking. That means better braking and longer brake life.

If your vehicle's engine ever stops while you are driving, brake normally but do not pump the brakes. If you do, the pedal could get harder to push down. If the engine stops, you will still have some power brake assist. But you will use it when you brake. Once the power assist is used up, it can take longer to stop and the brake pedal will be harder to push.

Adding non-dealer/non-retailer accessories can affect your vehicle's performance. See *Accessories and Modifications on page 6-3*.

## Antilock Brake System (ABS)

Your vehicle has the Antilock Brake System (ABS), an advanced electronic braking system that will help prevent a braking skid.

When you start the engine and begin to drive away, ABS will check itself. You might hear a momentary motor or clicking noise while this test is going on, and you might even notice that the brake pedal moves a little. This is normal.

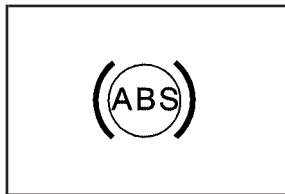

If there is a problem with ABS, this warning light will stay on. See *Antilock Brake System (ABS) Warning Light* on page 3-48.

Let us say the road is wet and you are driving safely. Suddenly, an animal jumps out in front of you. You slam on the brakes and continue braking. Here is what happens with ABS:

A computer senses that the wheels are slowing down. If one of the wheels is about to stop rolling, the computer will separately work the brakes at each wheel.

ABS can change the brake pressure to each wheel, as required, faster than any driver could. This can help you steer around the obstacle while braking hard.

As you brake, the computer keeps receiving updates on wheel speed and controls braking pressure accordingly.

Remember: ABS does not change the time you need to get your foot up to the brake pedal or always decrease stopping distance. If you get too close to the vehicle in front of you, you will not have time to apply the brakes if that vehicle suddenly slows or stops. Always leave enough room up ahead to stop, even though you have ABS.

## Using ABS

Do not pump the brakes. Just hold the brake pedal down firmly and let antilock work for you. You might hear a motor or clicking noise and feel the brake pedal move a little during a stop, but this is normal.

## Braking in Emergencies

With ABS, you can steer and brake at the same time. In many emergencies, steering can help more than even the very best braking.

### Brake Assist

This vehicle has a Brake Assist feature designed to assist the driver in stopping or decreasing vehicle speed in emergency driving conditions. This feature uses the stability system hydraulic brake control module to supplement the power brake system under conditions where the driver has quickly and forcefully applied the brake pedal in an attempt to quickly stop or slow down the vehicle. The stability system hydraulic brake control module increases brake pressure at each corner of the vehicle until the ABS activates. Minor brake pedal pulsations or pedal movement during this time is normal and the driver should continue to apply the brake pedal as the driving situation dictates. The Brake Assist feature will automatically disengage when the brake pedal is released or brake pedal pressure is quickly decreased.

## StabiliTrak<sup>®</sup> System

The StabiliTrak System is a computer controlled system that helps the driver maintain directional control of the vehicle in difficult driving conditions. This is accomplished by selectively applying any one of the vehicle's brakes.

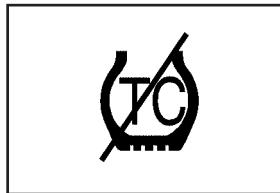

The Traction Control System (TCS)/StabiliTrak light is located on the instrument panel.

STABILITRAK ACTIVE comes on the Driver Information Center (DIC) when the system is working. See *DIC Warnings and Messages on page 3-60* for more information. The system may be heard or felt while it is working. This is normal.

The TCS/StabiliTrak light comes on the instrument panel, a chime will sound, and SERVICE STABILITRAK comes on the DIC if there is a problem with the system.

When this light and SERVICE STABILITRAK comes on, the system is not operational and needs to be serviced. Adjust your driving accordingly.

The system comes on automatically whenever the vehicle is started. To help maintain directional control of the vehicle, the system should always be left on. The system can be turned off if needed. If the StabiliTrak system is turned off, the Traction Control System will also be turned off. Adjust your driving accordingly.

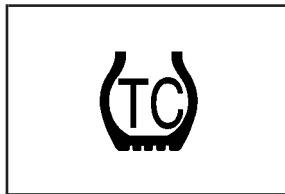

The Traction Control button is located on the console.

To turn the system off, press and hold the TCS/StabiliTrak button until the light comes on the instrument panel and STABILITRAK OFF comes on the DIC.

The system can be turned back on at any time by pressing the button. The TCS/StabiliTrak light turns off and STABILITRAK ON briefly comes on the DIC.

If the Tire Pressure Monitor (TPM) system detects a flat tire and FLAT TIRE comes on the DIC, or if the TPM system is not working and SERVICE TIRE MONITOR comes on the DIC, StabiliTrak can be affected in the following ways:

- StabiliTrak cannot be turned off by the driver.
- If StabiliTrak is off, it will be turned on automatically.
- Performance Mode is unavailable — XLR-V only.

## Performance Mode — XLR-V Only

**Notice:** When traction control is turned off, or Performance Mode is active, it is possible to lose traction. If a shift is attempted with the rear wheels spinning with a loss of traction, it is possible to cause damage to the transmission. Do not attempt to shift when the rear wheels do not have traction. Damage caused by misuse of the vehicle is not covered. See the warranty book for additional information.

For vehicles with this feature, the Performance Mode can be selected by pressing the TCS/StabiliTrak button on the console two times quickly. PERFORMANCE MODE comes on the DIC. Performance Mode allows the driver to have full control of the rear wheels while the StabiliTrak System helps maintain directional control of the vehicle by applying the brakes as necessary. The TCS/StabiliTrak light will not be on. The TCS will not be operating. Adjust your driving accordingly.

When the TCS/StabiliTrak button is pressed again, the StabiliTrak and Traction Control Systems will be on. The TRAC/STABILITRAK ON message will be displayed briefly in the DIC and a chime will be heard.

## Traction Control System (TCS)

The vehicle has a traction control system that limits wheel spin. This is especially useful in slippery road conditions. The system operates only if it senses that one or both of the rear wheels are spinning or beginning to lose traction. When this happens, the system works the rear brakes and reduces engine power to limit wheel spin.

The TRAC SYSTEM ACTIVE message will display on the Driver Information Center (DIC) when the traction control system is limiting wheel spin. See *DIC Warnings and Messages on page 3-60*. The system may be heard or felt while it is working, but this is normal.

If cruise control is being used when the traction control system begins to limit wheel spin, the cruise control will automatically disengage. Cruise control may be reengaged when road conditions allow. See *Adaptive Cruise Control on page 3-14* or *Cruise Control on page 3-11* for more information.

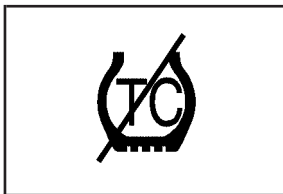

This warning light comes on if there is a problem with the traction control system.

See *StabiliTrak®/Traction Control System (TCS) Warning Light* on page 3-48. When this warning light is on, the system will not limit wheel spin. Adjust your driving accordingly.

The traction control system automatically comes on whenever the vehicle is started. To limit wheel spin, especially in slippery road conditions, the system should always be left on but can be turned off if needed. It may be necessary to turn the system off if the vehicle is stuck in sand, mud or snow and rocking the vehicle is required. See *Rocking Your Vehicle to Get It Out* on page 5-20 and *If Your Vehicle is Stuck in Sand, Mud, Ice, or Snow* on page 5-20 for more information.

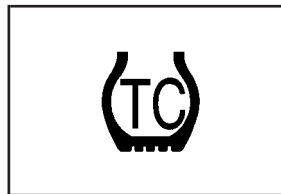

To turn the system off, press the traction control button located on the center console.

The TRACTION SYSTEM OFF message will display on the DIC and the traction control system warning light will come on. If the system is limiting wheel spin when the button is pressed, the TRACTION SYSTEM OFF message will display – but the system will not turn off right away. It will wait until there is no longer a current need to limit wheel spin.

The system can be turned back on at any time by pressing the button again. The TRACTION SYSTEM ON message should display briefly on the Driver Information Center. See *DIC Warnings and Messages* on page 3-60 for more information.

Adding non-GM accessories can affect the vehicle's performance. See *Accessories and Modifications* on page 6-3 for more information.

## Magnetic Ride Control™

With this feature, Magnetic Ride Control automatically adjusts the ride of the vehicle based on driving conditions. The controller receives input from the system to determine the proper ride. If the controller detects a problem within the system, the DIC will display a SERVICE RIDE CONTROL message. See *DIC Warnings and Messages on page 3-60* for more information. See your dealer/retailer for service.

## Limited-Slip Rear Axle

Vehicles with a limited-slip rear axle can give more traction on snow, mud, ice, sand or gravel. It works like a standard axle most of the time, but when traction is low, this feature allows the drive wheel with the most traction to move the vehicle.

## Steering

### Power Steering

If you lose power steering assist because the engine stops or the system is not functioning, you can steer but it will take much more effort.

## Magnetic Speed Variable Assist Steering System

This system continuously adjusts the effort you feel when steering at all vehicle speeds. It provides ease when parking, yet a firm, solid feel at highway speeds.

### Steering Tips

It is important to take curves at a reasonable speed.

Traction in a curve depends on the condition of the tires and the road surface, the angle at which the curve is banked, and your speed. While in a curve, speed is the one factor you can control.

If you need to reduce speed, do it before you enter the curve, while the front wheels are straight ahead.

Try to adjust the speed so you can drive through the curve. Maintain a reasonable, steady speed. Wait to accelerate until you are out of the curve, and then accelerate gently into the straightaway.



## Steering in Emergencies

There are times when steering can be more effective than braking. For example, you come over a hill and find a truck stopped in your lane, or a car suddenly pulls out from nowhere, or a child darts out from between parked cars and stops right in front of you. You can avoid these problems by braking — if you can stop in time. But sometimes you cannot; there is not room. That is the time for evasive action — steering around the problem.

Your vehicle can perform very well in emergencies like these. First apply the brakes. See *Braking on page 5-4*. It is better to remove as much speed as you can from a possible collision. Then steer around the problem, to the left or right depending on the space available.

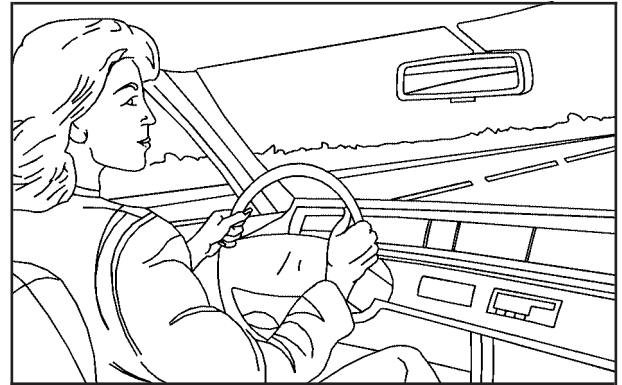

An emergency like this requires close attention and a quick decision. If you are holding the steering wheel at the recommended 9 and 3 o'clock positions, you can turn it a full 180 degrees very quickly without removing either hand. But you have to act fast, steer quickly, and just as quickly straighten the wheel once you have avoided the object.

The fact that such emergency situations are always possible is a good reason to practice defensive driving at all times and wear safety belts properly.

## Off-Road Recovery

Your vehicle's right wheels can drop off the edge of a road onto the shoulder while driving.

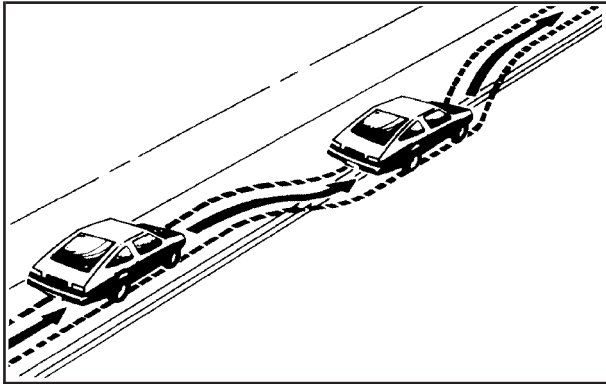

If the level of the shoulder is only slightly below the pavement, recovery should be fairly easy. Ease off the accelerator and then, if there is nothing in the way, steer so that your vehicle straddles the edge of the pavement. Turn the steering wheel 3 to 5 inches, 76 to 127 mm, (about one-eighth turn) until the right front tire contacts the pavement edge. Then turn the steering wheel to go straight down the roadway.

## Passing

Passing another vehicle on a two-lane road can be dangerous. To reduce the risk of danger while passing:

- Look down the road, to the sides, and to crossroads for situations that might affect a successful pass. If in doubt, wait.
- Watch for traffic signs, pavement markings, and lines that could indicate a turn or an intersection. Never cross a solid or double-solid line on your side of the lane.
- Do not get too close to the vehicle you want to pass. Doing so can reduce your visibility.
- Wait your turn to pass a slow vehicle.
- When you are being passed, ease to the right.

## Loss of Control

Let us review what driving experts say about what happens when the three control systems — brakes, steering, and acceleration — do not have enough friction where the tires meet the road to do what the driver has asked.

In any emergency, do not give up. Keep trying to steer and constantly seek an escape route or area of less danger.

## Skidding

In a skid, a driver can lose control of the vehicle. Defensive drivers avoid most skids by taking reasonable care suited to existing conditions, and by not overdriving those conditions. But skids are always possible.

The three types of skids correspond to your vehicle's three control systems. In the braking skid, the wheels are not rolling. In the steering or cornering skid, too much speed or steering in a curve causes tires to slip and lose cornering force. And in the acceleration skid, too much throttle causes the driving wheels to spin.

Remember: Any traction control system helps avoid only the acceleration skid. If your traction control system is off, then an acceleration skid is best handled by easing your foot off the accelerator pedal.

If your vehicle starts to slide, ease your foot off the accelerator pedal and quickly steer the way you want the vehicle to go. If you start steering quickly enough, your vehicle may straighten out. Always be ready for a second skid if it occurs.

Of course, traction is reduced when water, snow, ice, gravel, or other material is on the road. For safety, you will want to slow down and adjust your driving to these conditions. It is important to slow down on slippery surfaces because stopping distance will be longer and vehicle control more limited.

While driving on a surface with reduced traction, try your best to avoid sudden steering, acceleration, or braking, including reducing vehicle speed by shifting to a lower gear. Any sudden changes could cause the tires to slide. You may not realize the surface is slippery until your vehicle is skidding. Learn to recognize warning clues — such as enough water, ice, or packed snow on the road to make a mirrored surface — and slow down when you have any doubt.

Remember: Any Antilock Brake System (ABS) helps avoid only the braking skid.

## Racing or Other Competitive Driving (XLR-V)

See your warranty book before using your vehicle for racing or other competitive driving.

**Notice:** If you use your vehicle for racing or other competitive driving, the engine may use more oil than it would with normal use. Low oil levels can damage the engine. Be sure to check the oil level often during racing or other competitive driving and keep the level at or near 2 quarts (2 L) above the upper mark that shows the proper operating range on the engine oil dipstick. For information on how to add oil, see *Engine Oil on page 6-15*. After the competitive driving, remove excess oil so that the level on the dipstick is not above the upper mark that shows the proper operating range.

## Driving at Night

Night driving is more dangerous than day driving because some drivers are likely to be impaired — by alcohol or drugs, with night vision problems, or by fatigue.

Night driving tips include:

- Drive defensively.
- Do not drink and drive.
- Reduce headlamp glare by adjusting the inside rearview mirror.
- Slow down and keep more space between you and other vehicles because headlamps can only light up so much road ahead.
- Watch for animals.
- When tired, pull off the road.
- Do not wear sunglasses.
- Avoid staring directly into approaching headlamps.
- Keep the windshield and all glass on your vehicle clean — inside and out.
- Keep your eyes moving, especially during turns or curves.

No one can see as well at night as in the daytime. But, as we get older, these differences increase. A 50-year-old driver might need at least twice as much light to see the same thing at night as a 20-year-old.

## Driving in Rain and on Wet Roads

Rain and wet roads can reduce vehicle traction and affect your ability to stop and accelerate. Always drive slower in these types of driving conditions and avoid driving through large puddles and deep-standing or flowing water.

### CAUTION:

Wet brakes can cause crashes. They might not work as well in a quick stop and could cause pulling to one side. You could lose control of the vehicle.

After driving through a large puddle of water or a car/vehicle wash, lightly apply the brake pedal until the brakes work normally.

Flowing or rushing water creates strong forces. Driving through flowing water could cause your vehicle to be carried away. If this happens, you and other vehicle occupants could drown. Do not ignore police warnings and be very cautious about trying to drive through flowing water.

## Hydroplaning

Hydroplaning is dangerous. Water can build up under your vehicle's tires so they actually ride on the water. This can happen if the road is wet enough and you are going fast enough. When your vehicle is hydroplaning, it has little or no contact with the road.

There is no hard and fast rule about hydroplaning. The best advice is to slow down when the road is wet.

## Other Rainy Weather Tips

Besides slowing down, other wet weather driving tips include:

- Allow extra following distance.
- Pass with caution.
- Keep windshield wiping equipment in good shape.
- Keep the windshield washer fluid reservoir filled.
- Have good tires with proper tread depth. See *Tires on page 6-46*.
- Turn off cruise control.

## Before Leaving on a Long Trip

To prepare your vehicle for a long trip, consider having it serviced by your dealer/retailer before departing.

Things to check on your own include:

- *Windshield Washer Fluid*: Reservoir full? Windows clean — inside and outside?
- *Wiper Blades*: In good shape?
- *Fuel, Engine Oil, Other Fluids*: All levels checked?
- *Lamps*: Do they all work and are lenses clean?
- *Tires*: Are treads good? Are tires inflated to recommended pressure?
- *Weather and Maps*: Safe to travel? Have up-to-date maps?

## Highway Hypnosis

Always be alert and pay attention to your surroundings while driving. If you become tired or sleepy, find a safe place to park your vehicle and rest.

Other driving tips include:

- Keep the vehicle well ventilated.
- Keep interior temperature cool.
- Keep your eyes moving — scan the road ahead and to the sides.
- Check the rearview mirror and vehicle instruments often.

## Hill and Mountain Roads

Driving on steep hills or through mountains is different than driving on flat or rolling terrain. Tips for driving in these conditions include:

- Keep the vehicle serviced and in good shape.
- Check all fluid levels and brakes, tires, cooling system, and transmission.
- Going down steep or long hills, shift to a lower gear.

### CAUTION:

If you do not shift down, the brakes could get so hot that they would not work well. You would then have poor braking or even none going down a hill. You could crash. Shift down to let the engine assist the brakes on a steep downhill slope.

### CAUTION:

Coasting downhill in N (Neutral) or with the ignition off is dangerous. The brakes will have to do all the work of slowing down and they could get so hot that they would not work well. You would then have poor braking or even none going down a hill. You could crash. Always have the engine running and the vehicle in gear when going downhill.

- Stay in your own lane. Do not swing wide or cut across the center of the road. Drive at speeds that let you stay in your own lane.
- Top of hills: Be alert — something could be in your lane (stalled car, accident).
- Pay attention to special road signs (falling rocks area, winding roads, long grades, passing or no-passing zones) and take appropriate action.

## Winter Driving

### Driving on Snow or Ice

Drive carefully when there is snow or ice between the tires and the road, creating less traction or grip. Wet ice can occur at about 32°F (0°C) when freezing rain begins to fall, resulting in even less traction. Avoid driving on wet ice or in freezing rain until roads can be treated with salt or sand.

Drive with caution, whatever the condition. Accelerate gently so traction is not lost. Accelerating too quickly causes the wheels to spin and makes the surface under the tires slick, so there is even less traction.

Try not to break the fragile traction. If you accelerate too fast, the drive wheels will spin and polish the surface under the tires even more.

The *Traction Control System (TCS)* on page 5-8 improves the ability to accelerate on slippery roads, but slow down and adjust your driving to the road conditions. The *StabiliTrak® System* on page 5-6 might also activate. When driving through deep snow, turn off the traction control system to help maintain vehicle motion at lower speeds.

The *Antilock Brake System (ABS)* on page 5-5 improves vehicle stability during hard stops on a slippery road, but apply the brakes sooner than when on dry pavement.

Allow greater following distance on any slippery road and watch for slippery spots. Icy patches can occur on otherwise clear roads in shaded areas. The surface of a curve or an overpass can remain icy when the surrounding roads are clear. Avoid sudden steering maneuvers and braking while on ice.

Turn off cruise control, if equipped, on slippery surfaces.

### Blizzard Conditions

Being stuck in snow can be in a serious situation. Stay with the vehicle unless there is help nearby. If possible, use the *Roadside Service* on page 8-7. To get help and keep everyone in the vehicle safe:

- Turn on the *Hazard Warning Flashers* on page 3-6.
- Tie a red cloth to an outside mirror.



 **CAUTION:**

Snow can trap engine exhaust under the vehicle. This may cause exhaust gases to get inside. Engine exhaust contains carbon monoxide (CO) which cannot be seen or smelled. It can cause unconsciousness and even death.

If the vehicle is stuck in the snow:

- Clear away snow from around the base of your vehicle, especially any that is blocking the exhaust pipe.
- Check again from time to time to be sure snow does not collect there.
- Open a window about two inches on the side of the vehicle that is away from the wind to bring in fresh air.
- Fully open the air outlets on or under the instrument panel.
- Adjust the Climate Control system to a setting that circulates the air inside the vehicle and set the fan speed to the highest setting. See Climate Control System in the Index.

For more information about carbon monoxide, see *Engine Exhaust* on page 2-36.

CAUTION: (Continued)

**CAUTION: (Continued)**

Snow can trap exhaust gases under your vehicle. This can cause deadly CO (carbon monoxide) gas to get inside. CO could overcome you and kill you. You cannot see it or smell it, so you might not know it is in your vehicle. Clear away snow from around the base of your vehicle, especially any that is blocking the exhaust.

Run the engine for short periods only as needed to keep warm, but be careful.

To save fuel, run the engine for only short periods as needed to warm the vehicle and then shut the engine off and close the window most of the way to save heat. Repeat this until help arrives but only when you feel really uncomfortable from the cold. Moving about to keep warm also helps.

If it takes some time for help to arrive, now and then when you run the engine, push the accelerator pedal slightly so the engine runs faster than the idle speed. This keeps the battery charged to restart the vehicle and to signal for help with the headlamps. Do this as little as possible to save fuel.

## If Your Vehicle is Stuck in Sand, Mud, Ice, or Snow

Slowly and cautiously spin the wheels to free the vehicle when stuck in sand, mud, ice, or snow. See *Rocking Your Vehicle to Get It Out* on page 5-20.

If the vehicle has a traction system, it can often help to free a stuck vehicle. Refer to the vehicle's traction system in the Index. If stuck too severely for the traction system to free the vehicle, turn the traction system off and use the rocking method.

### CAUTION:

If you let your vehicle's tires spin at high speed, they can explode, and you or others could be injured. The vehicle can overheat, causing an engine compartment fire or other damage. Spin the wheels as little as possible and avoid going above 35 mph (55 km/h) as shown on the speedometer.

For information about using tire chains on the vehicle, see *Tire Chains* on page 6-68.

## Rocking Your Vehicle to Get It Out

Turn the steering wheel left and right to clear the area around the front wheels. Turn off any traction or stability system. Shift back and forth between R (Reverse) and a forward gear, spinning the wheels as little as possible. To prevent transmission wear, wait until the wheels stop spinning before shifting gears. Release the accelerator pedal while shifting, and press lightly on the accelerator pedal when the transmission is in gear. Slowly spinning the wheels in the forward and reverse directions causes a rocking motion that could free the vehicle. If that does not get the vehicle out after a few tries, it might need to be towed out. If the vehicle does need to be towed out, see *Towing Your Vehicle* on page 5-26.

## Loading the Vehicle

It is very important to know how much weight your vehicle can carry. This weight is called the vehicle capacity weight and includes the weight of all occupants, cargo, and all nonfactory-installed options. Two labels on your vehicle show how much weight it may properly carry, the Tire and Loading Information label and the Certification label.

### CAUTION:

Do not load the vehicle any heavier than the Gross Vehicle Weight Rating (GVWR), or either the maximum front or rear Gross Axle Weight Rating (GAWR). If you do, parts on the vehicle can break, and it can change the way your vehicle handles. These could cause you to lose control and crash. Also, overloading can shorten the life of the vehicle.

## Tire and Loading Information Label

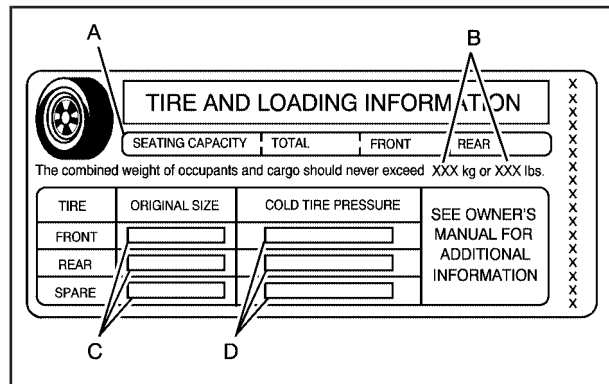

**Label Example**

A vehicle specific Tire and Loading Information label is attached to the center pillar (B-pillar) of your vehicle. With the driver's door open, you will find the label attached below the door latch. This label shows the number of occupant seating positions (A), and the maximum vehicle capacity weight (B) in kilograms and pounds.

The Tire and Loading Information label also shows the size of the original equipment tires (C) and the recommended cold tire inflation pressures (D).

For more information on tires and inflation see *Tires on page 6-46* and *Inflation - Tire Pressure on page 6-54*.

There is also important loading information on the vehicle Certification label. It tells you the Gross Vehicle Weight Rating (GVWR) and the Gross Axle Weight Rating (GAWR) for the front and rear axle. See "Certification Label" later in this section.

### **Steps for Determining Correct Load Limit**

1. Locate the statement "The combined weight of occupants and cargo should never exceed XXX kg or XXX lbs" on your vehicle's placard.
2. Determine the combined weight of the driver and passengers that will be riding in your vehicle.
3. Subtract the combined weight of the driver and passengers from XXX kg or XXX lbs.
4. The resulting figure equals the available amount of cargo and luggage load capacity. For example, if the "XXX" amount equals 1400 lbs and there will be five 150 lb passengers in your vehicle, the amount of available cargo and luggage load capacity is 650 lbs ( $1400 - 750 (5 \times 150) = 650$  lbs).
5. Determine the combined weight of luggage and cargo being loaded on the vehicle. That weight may not safely exceed the available cargo and luggage load capacity calculated in Step 4.
6. If your vehicle will be towing a trailer, the load from your trailer will be transferred to your vehicle. Consult this manual to determine how this reduces the available cargo and luggage load capacity of your vehicle.

Your vehicle is neither designed nor intended to tow a trailer.

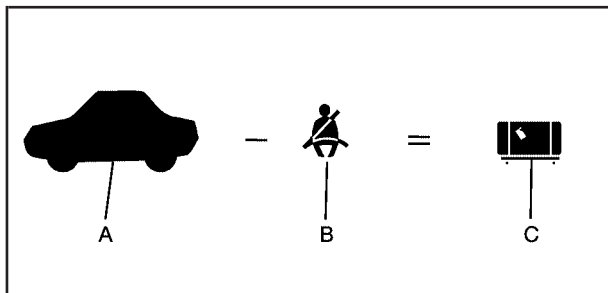

**Example 1**

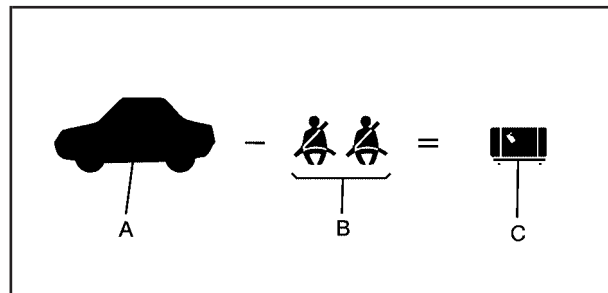

**Example 2**

Item	Description	Total
A	Vehicle Capacity Weight for Example 1 =	400 lbs (181 kg)
B	Subtract Occupant Weight @ 150 lbs (68 kg) x 1 =	150 lbs (68 kg)
C	Available Occupant and Cargo Weight =	250 lbs (113 kg)

Item	Description	Total
A	Vehicle Capacity Weight for Example 2 =	400 lbs (181 kg)
B	Subtract Occupant Weight @ 150 lbs (68 kg) x 2 =	300 lbs (136 kg)
C	Available Cargo Weight =	100 lbs (45 kg)

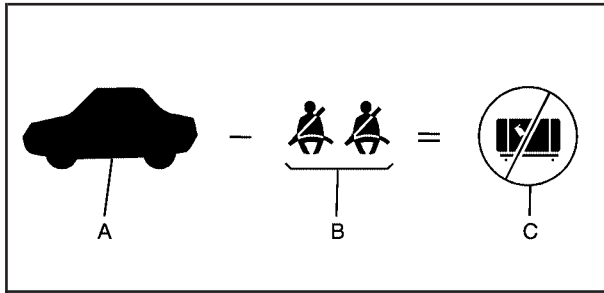

**Example 3**

Item	Description	Total
A	Vehicle Capacity Weight for Example 3 =	400 lbs (181 kg)
B	Subtract Occupant Weight @ 200 lbs (91 kg) x 2 =	400 lbs (181 kg)
C	Available Cargo Weight =	0 lbs (0 kg)

Refer to your vehicle's Tire and Loading Information label for specific information about your vehicle's capacity weight and seating

positions. The combined weight of the driver, passengers, and cargo should never exceed your vehicle's capacity weight.

### Certification Label

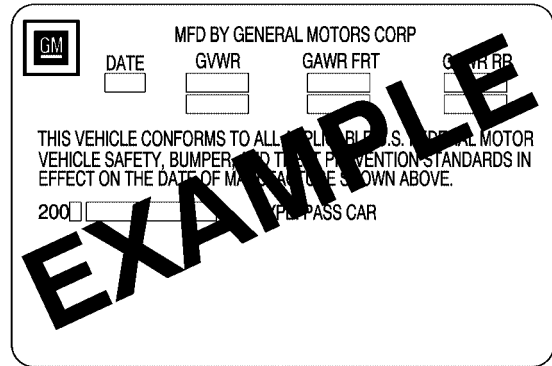

A vehicle specific Certification label is attached to the rear edge of the driver's door. It tells you the gross weight capacity of your vehicle, called the Gross Vehicle Weight Rating (GVWR).

The GVWR includes the weight of the vehicle, all occupants, fuel, and cargo. Never exceed the GVWR for your vehicle, or the Gross Axle Weight Rating (GAWR) for either the front or rear axle.

And, if you do have a heavy load, you should spread it out.

 **CAUTION:**

Do not load the vehicle any heavier than the Gross Vehicle Weight Rating (GVWR), or either the maximum front or rear Gross Axle Weight Rating (GAWR). If you do, parts on the vehicle can break, and it can change the way your vehicle handles. These could cause you to lose control and crash. Also, overloading can shorten the life of the vehicle.

**Notice:** Overloading your vehicle may cause damage. Repairs would not be covered by your warranty. Do not overload your vehicle.

If you put things inside your vehicle — like suitcases, tools, packages, or anything else — they will go as fast as the vehicle goes. If you have to stop or turn quickly, or if there is a crash, they will keep going.

 **CAUTION:**

Things you put inside your vehicle can strike and injure people in a sudden stop or turn, or in a crash.

- Put things in the rear area of your vehicle. Try to spread the weight evenly.
- Never stack heavier things, like suitcases, inside the vehicle so that some of them are above the tops of the seats.
- Do not leave an unsecured child restraint in your vehicle.
- When you carry something inside the vehicle, secure it whenever you can.

# Towing

## Towing Your Vehicle

Consult your dealer/retailer or a professional towing service if the disabled vehicle needs to be towed. See *Roadside Service on page 8-7*.

## Recreational Vehicle Towing

**Notice:** Dolly towing or dinghy towing the vehicle may cause damage because of reduced ground clearance. Always put the vehicle on a flatbed truck.

The vehicle was neither designed nor intended to be towed with any of its wheels on the ground. If the vehicle must be towed, see “Towing Your Vehicle” earlier in this section.

## Towing a Trailer

The vehicle is neither designed nor intended to tow a trailer.



## Section 6 Service and Appearance Care

---

<b>Service</b> .....	6-3	Engine Overheating .....	6-27
Accessories and Modifications .....	6-3	Overheated Engine Protection	
California Proposition 65 Warning .....	6-4	Operating Mode .....	6-29
California Perchlorate Materials Requirements .....	6-4	Power Steering Fluid .....	6-30
Doing Your Own Service Work .....	6-4	Windshield Washer Fluid .....	6-31
Adding Equipment to the Outside of the		Brakes .....	6-32
Vehicle .....	6-5	Battery .....	6-35
<b>Fuel</b> .....	6-5	Jump Starting .....	6-36
Gasoline Octane .....	6-5	<b>Rear Axle</b> .....	6-41
Gasoline Specifications .....	6-6	<b>Headlamp Aiming</b> .....	6-42
California Fuel .....	6-6	Headlamp Vertical Aiming .....	6-43
Additives .....	6-6	<b>Bulb Replacement</b> .....	6-45
Fuels in Foreign Countries .....	6-7	<b>Windshield Replacement</b> .....	6-45
Filling the Tank .....	6-8	<b>Windshield Wiper Blade Replacement</b> .....	6-45
Filling a Portable Fuel Container .....	6-10	<b>Tires</b> .....	6-46
<b>Checking Things Under the Hood</b> .....	6-10	Winter Tires (XLR-V) .....	6-47
Hood Release .....	6-11	Tire Sidewall Labeling .....	6-48
Engine Compartment Overview .....	6-12	Tire Terminology and Definitions .....	6-50
Engine Oil .....	6-15	Run-Flat Tires .....	6-52
Engine Oil Life System .....	6-18	Inflation - Tire Pressure .....	6-54
Engine Air Cleaner/Filter .....	6-20	Tire Pressure Monitor System .....	6-55
Automatic Transmission Fluid .....	6-21	Tire Pressure Monitor Operation .....	6-57
Cooling System .....	6-22	Tire Inspection and Rotation .....	6-60
Engine Coolant .....	6-23		

## Section 6 Service and Appearance Care

---

When It Is Time for New Tires .....	6-61	Windshield and Wiper Blades .....	6-78
Buying New Tires .....	6-62	Aluminum or Chrome-Plated Wheels and Trim .....	6-79
Different Size Tires and Wheels .....	6-63	Tires .....	6-80
Uniform Tire Quality Grading .....	6-64	Sheet Metal Damage .....	6-80
Wheel Alignment and Tire Balance .....	6-65	Finish Damage .....	6-80
Wheel Replacement .....	6-66	Underbody Maintenance .....	6-80
Tire Chains .....	6-68	Fiberglass Springs (Composite Springs) .....	6-81
Lifting the Vehicle .....	6-68	Chemical Paint Spotting .....	6-81
If a Tire Goes Flat .....	6-72	<b>Vehicle Identification</b> .....	6-81
<b>Appearance Care</b> .....	6-74	Vehicle Identification Number (VIN) .....	6-81
Interior Cleaning .....	6-74	Service Parts Identification Label .....	6-82
Fabric/Carpet .....	6-75	<b>Electrical System</b> .....	6-82
Leather .....	6-75	Add-On Electrical Equipment .....	6-82
Instrument Panel, Vinyl, and Other Plastic Surfaces .....	6-76	Windshield Wiper Fuses .....	6-83
Wood Panels .....	6-76	Power Windows and Other Power Options .....	6-83
Speaker Covers .....	6-76	Fuses and Circuit Breakers .....	6-83
Care of Safety Belts .....	6-76	Instrument Panel Fuse Block .....	6-83
Weatherstrips .....	6-77	Underhood Fuse Block .....	6-87
Washing Your Vehicle .....	6-77	<b>Capacities and Specifications</b> .....	6-90
Cleaning Exterior Lamps/Lenses .....	6-77		
Finish Care .....	6-78		

## Service

For service and parts needs, visit your dealer/retailer. You will receive genuine GM parts and GM-trained and supported service people.

Genuine GM parts have one of these marks:

***ACDelco***<sup>®</sup>

---

**GM** Parts<sup>®</sup>

---

**GM** | Goodwrench<sup>®</sup>

---

**GM** Accessories<sup>®</sup>

## Accessories and Modifications

When non-dealer/non-retailer accessories are added to the vehicle, they can affect vehicle performance and safety, including such things as airbags, braking, stability, ride and handling, emissions systems, aerodynamics, durability, and electronic systems like antilock brakes, traction control, and stability control. Some of these accessories could even cause malfunction or damage not covered by the vehicle warranty.

Damage to vehicle components resulting from the installation or use of non-GM certified parts, including control module modifications, are not covered under the terms of the vehicle warranty and may affect remaining warranty coverage for affected parts.

GM Accessories are designed to complement and function with other systems on the vehicle. Your GM dealer/retailer can accessorize the vehicle using genuine GM Accessories. When you go to your GM dealer/retailer and ask for GM Accessories, you will know that GM-trained and supported service technicians will perform the work using genuine GM Accessories.

Also, see *Adding Equipment to Your Airbag-Equipped Vehicle on page 1-50*.

## California Proposition 65 Warning

Most motor vehicles, including this one, contain and/or emit chemicals known to the State of California to cause cancer and birth defects or other reproductive harm. Engine exhaust, many parts and systems (including some inside the vehicle), many fluids, and some component wear by-products contain and/or emit these chemicals.

## California Perchlorate Materials Requirements

Certain types of automotive applications, such as airbag initiators, seat belt pretensioners, and lithium batteries contained in remote keyless transmitters, may contain perchlorate materials. Special handling may be necessary. For additional information, see [www.dtsc.ca.gov/hazardouswaste/perchlorate](http://www.dtsc.ca.gov/hazardouswaste/perchlorate).

## Doing Your Own Service Work

### CAUTION:

You can be injured and the vehicle could be damaged if you try to do service work on a vehicle without knowing enough about it.

- Be sure you have sufficient knowledge, experience, the proper replacement parts, and tools before attempting any vehicle maintenance task.
- Be sure to use the proper nuts, bolts, and other fasteners. English and metric fasteners can be easily confused. If the wrong fasteners are used, parts can later break or fall off. You could be hurt.

If doing some of your own service work, use the proper service manual. It tells you much more about how to service the vehicle than this manual can. To order the proper service manual, see *Service Publications Ordering Information on page 8-15*.

This vehicle has an airbag system. Before attempting to do your own service work, see *Servicing Your Airbag-Equipped Vehicle on page 1-50*.

Keep a record with all parts receipts and list the mileage and the date of any service work performed. See *Maintenance Record on page 7-15*.

## **Adding Equipment to the Outside of the Vehicle**

Things added to the outside of the vehicle can affect the airflow around it. This can cause wind noise and can affect fuel economy and windshield washer performance. Check with your dealer/retailer before adding equipment to the outside of the vehicle.

## **Fuel**

Use of the recommended fuel is an important part of the proper maintenance of this vehicle. To help keep the engine clean and maintain optimum vehicle performance, we recommend the use of gasoline advertised as TOP TIER Detergent Gasoline.

The 8th digit of the Vehicle Identification Number (VIN) shows the code letter or number that identifies the vehicle's engine. The VIN is at the top left of the instrument panel. See *Vehicle Identification Number (VIN) on page 6-81*.

## **Gasoline Octane**

If the vehicle has the 4.6L V8 engine (VIN Code A), use premium unleaded gasoline with a posted octane rating of 91 or higher. You can also use regular unleaded gasoline rated at 87 octane or higher, but the vehicle's acceleration could be slightly reduced, and you might notice a slight audible knocking noise, commonly referred to as spark knock. If the octane is less than 87, you might notice a heavy knocking noise when you drive. If this occurs, use a gasoline rated at 87 octane or higher as soon as possible. Otherwise, you could damage the engine. If you are using gasoline rated at 87 octane or higher and you hear heavy knocking, the engine needs service.

If the vehicle has the 4.4L V8 engine (VIN Code D), use premium unleaded gasoline with a posted octane rating of 91 or higher. For best performance, use premium unleaded gasoline with a posted octane rating of 93. In an emergency, you can use regular unleaded gasoline with an octane rating of 87 or higher. If 87 octane fuel is used, do not perform any aggressive driving maneuvers such as wide open throttle applications. You might also hear audible spark knock during acceleration. Refill the tank with premium fuel as soon as possible to avoid damaging the engine. If you are using gasoline rated at 91 octane or higher and you hear heavy knocking, the engine needs service.

## Gasoline Specifications

At a minimum, gasoline should meet ASTM specification D 4814 in the United States or CAN/CGSB-3.5 or 3.511 in Canada. Some gasolines contain an octane-enhancing additive called methylcyclopentadienyl manganese tricarbonyl (MMT). We recommend against the use of gasolines containing MMT. See *Additives on page 6-6* for additional information.

## California Fuel

If the vehicle is certified to meet California Emissions Standards, it is designed to operate on fuels that meet California specifications. See the underhood emission control label. If this fuel is not available in states adopting California emissions standards, the vehicle will operate satisfactorily on fuels meeting federal specifications, but emission control system performance might be affected. The malfunction indicator lamp could turn on and the vehicle might fail a smog-check test. See *Malfunction Indicator Lamp on page 3-50*. If this occurs, return to your authorized dealer/retailer for diagnosis. If it is determined that the condition is caused by the type of fuel used, repairs might not be covered by the vehicle warranty.

## Additives

To provide cleaner air, all gasolines in the United States are now required to contain additives that help prevent engine and fuel system deposits from forming, allowing the emission control system to work properly. In most cases, you should not have to add anything to the fuel. However, some gasolines contain only the minimum amount of additive required to meet U.S. Environmental Protection Agency regulations. To help keep fuel injectors

and intake valves clean, or if the vehicle experiences problems due to dirty injectors or valves, look for gasoline that is advertised as TOP TIER Detergent Gasoline.

For customers who do not use TOP TIER Detergent Gasoline regularly, one bottle of GM Fuel System Treatment PLUS, added to the fuel tank at every engine oil change, can help clean deposits from fuel injectors and intake valves. GM Fuel System Treatment PLUS is the only gasoline additive recommended by General Motors.

Also, your dealer/retailer has additives that will help correct and prevent most deposit-related problems.

Gasolines containing oxygenates, such as ethers and ethanol, and reformulated gasolines might be available in your area. We recommend that you use these gasolines, if they comply with the specifications described earlier. However, E85 (85% ethanol) and other fuels containing more than 10% ethanol must not be used in vehicles that were not designed for those fuels.

**Notice:** This vehicle was not designed for fuel that contains methanol. Do not use fuel containing methanol. It can corrode metal parts in the fuel system and also damage plastic and rubber parts. That damage would not be covered under the vehicle warranty.

Some gasolines that are not reformulated for low emissions can contain an octane-enhancing additive called methylcyclopentadienyl manganese tricarbonyl (MMT); ask the attendant where you buy gasoline whether the fuel contains MMT. We recommend against the use of such gasolines. Fuels containing MMT can reduce the life of spark plugs and the performance of the emission control system could be affected. The malfunction indicator lamp might turn on. If this occurs, return to your dealer/retailer for service.

## Fuels in Foreign Countries

If you plan on driving in another country outside the United States or Canada, the proper fuel might be hard to find. Never use leaded gasoline or any other fuel not recommended in the previous text on fuel. Costly repairs caused by use of improper fuel would not be covered by the vehicle warranty.

To check the fuel availability, ask an auto club, or contact a major oil company that does business in the country where you will be driving.

## Filling the Tank

### CAUTION:

Fuel vapor burns violently and a fuel fire can cause bad injuries. To help avoid injuries to you and others, read and follow all the instructions on the pump island. Turn off the engine when you are refueling. Do not smoke if you are near fuel or refueling the vehicle. Do not use cellular phones. Keep sparks, flames, and smoking materials away from fuel. Do not leave the fuel pump unattended when refueling the vehicle. This is against the law in some places. Do not re-enter the vehicle while pumping fuel. Keep children away from the fuel pump; never let children pump fuel.

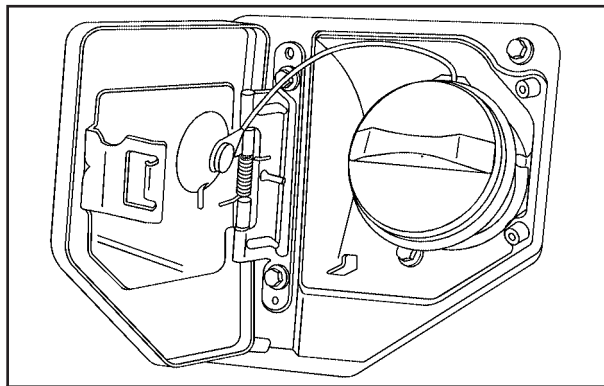

The tethered fuel cap is located behind a hinged fuel door on the driver side of the vehicle.

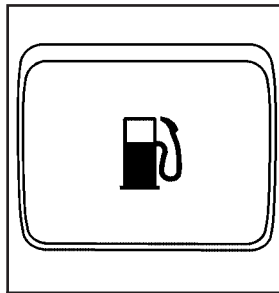

The fuel door release button is located on the left side of the instrument panel. The button only works when the vehicle is in P (Park) or N (Neutral) and the valet lockout button is in OFF.



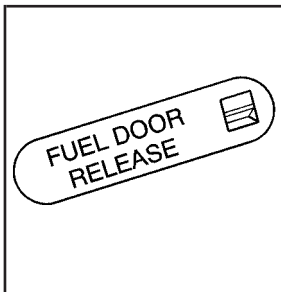

An alternate fuel door release is located inside the trunk behind a panel on the driver side of the vehicle. Pull the handle to release the fuel door.

To remove the fuel cap, turn it slowly counterclockwise. The fuel cap has a spring in it; if the cap is released too soon, it will spring back to the right.

While refueling, hang the tethered fuel cap from the hook on the fuel door.

### CAUTION:

Fuel can spray out on you if you open the fuel cap too quickly. If you spill fuel and then something ignites it, you could be badly burned. This spray can happen if the tank is nearly full, and is more likely in hot weather. Open the fuel cap slowly and wait for any hiss noise to stop. Then unscrew the cap all the way.

Be careful not to spill fuel. Do not top off or overfill the tank and wait a few seconds after you have finished pumping before removing the nozzle. Clean fuel from painted surfaces as soon as possible. See *Washing Your Vehicle on page 6-77*.

When replacing the fuel cap, turn it clockwise until it clicks. Make sure the cap is fully installed. The diagnostic system can determine if the fuel cap has been left off or improperly installed. This would allow fuel to evaporate into the atmosphere. See *Malfunction Indicator Lamp on page 3-50*.

The CHECK GAS CAP message in the Driver Information Center (DIC) will be displayed if the fuel cap is not properly installed.

### CAUTION:

If a fire starts while you are refueling, do not remove the nozzle. Shut off the flow of fuel by shutting off the pump or by notifying the station attendant. Leave the area immediately.

**Notice:** If you need a new fuel cap, be sure to get the right type. Your dealer/retailer can get one for you. If you get the wrong type, it may not fit properly. This may cause the malfunction indicator lamp to light and may damage the fuel tank and emissions system. See *Malfunction Indicator Lamp on page 3-50*.

## Filling a Portable Fuel Container

### CAUTION:

Never fill a portable fuel container while it is in the vehicle. Static electricity discharge from the container can ignite the fuel vapor. You can be badly burned and the vehicle damaged if this occurs. To help avoid injury to you and others:

- Dispense fuel only into approved containers.
- Do not fill a container while it is inside a vehicle, in a vehicle's trunk, pickup bed, or on any surface other than the ground.
- Bring the fill nozzle in contact with the inside of the fill opening before operating the nozzle. Contact should be maintained until the filling is complete.
- Do not smoke while pumping fuel.
- Do not use a cellular phone while pumping fuel.

## Checking Things Under the Hood

### CAUTION:

An electric fan under the hood can start up and injure you even when the engine is not running. Keep hands, clothing, and tools away from any underhood electric fan.

### CAUTION:

Things that burn can get on hot engine parts and start a fire. These include liquids like fuel, oil, coolant, brake fluid, windshield washer and other fluids, and plastic or rubber. You or others could be burned. Be careful not to drop or spill things that will burn onto a hot engine.

## Hood Release

To lift the hood, use the following steps:

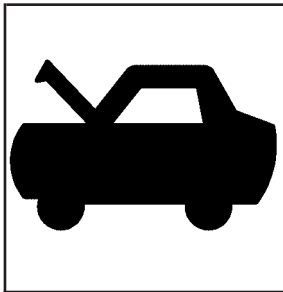

1. Pull the lever with this symbol on it. It is located on the lower left side of the instrument panel.

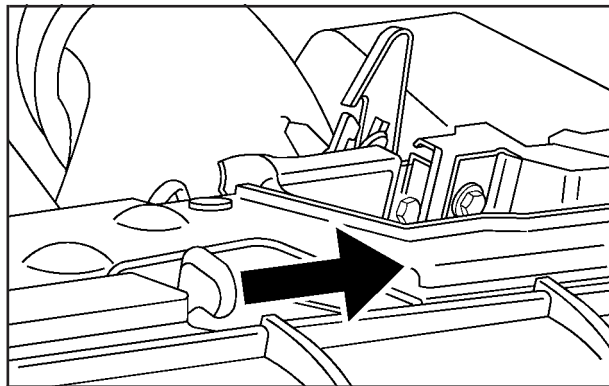

2. Then go to the front of the vehicle and locate the secondary hood release lever. The lever is under the hood near the center of the vehicle. Move the release lever to the right and raise the hood.

Before closing the hood, be sure all filler caps are on properly. Then pull the hood down and close it firmly.

# Engine Compartment Overview

When you open the hood on the 4.6L V8 engine, here is what you will see:

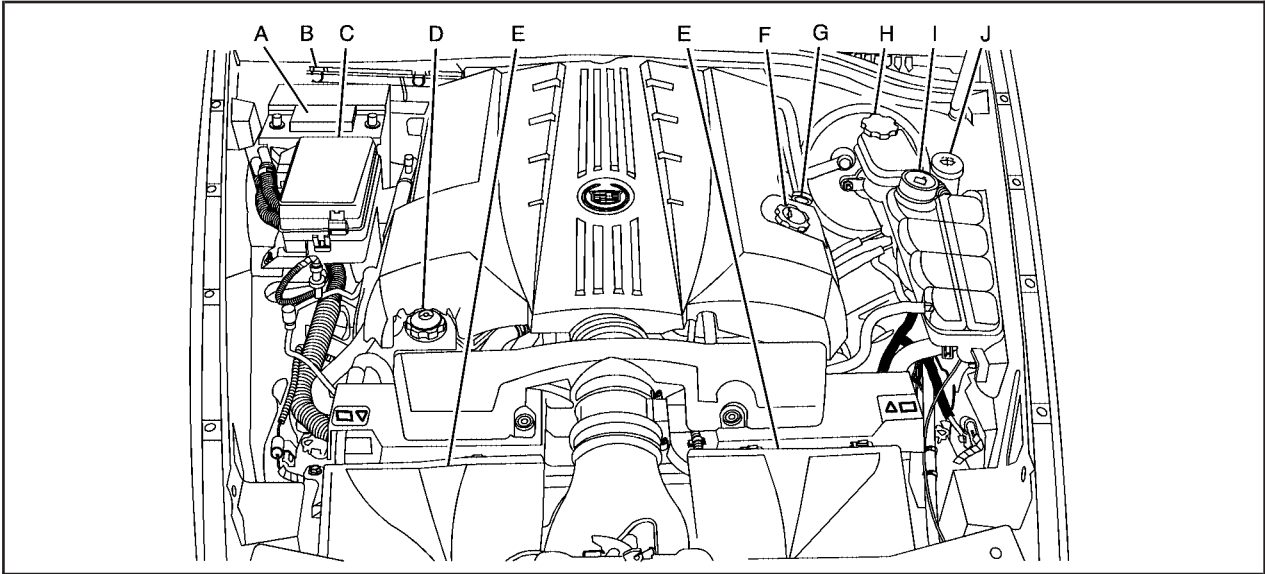

- A. Battery. See *Battery on page 6-35.*
- B. Passenger Compartment Air Filter. See *Passenger Compartment Air Filter on page 3-41.*
- C. Underhood Fuse Block. See *Underhood Fuse Block on page 6-87.*
- D. Power Steering Fluid. See *Power Steering Fluid on page 6-30.*
- E. Engine Air Cleaner/Filter. See *Engine Air Cleaner/Filter on page 6-20.*
- F. Engine Oil Fill Cap. See “When to Add Engine Oil” under *Engine Oil on page 6-15.*
- G. Engine Oil Dipstick. See “Checking Engine Oil” under *Engine Oil on page 6-15.*
- H. Brake Master Cylinder Reservoir. See “Brake Fluid” under *Brakes on page 6-32.*
- I. Engine Coolant Surge Tank and Pressure Cap. See *Cooling System on page 6-22.*
- J. Windshield Washer Fluid Reservoir. See “Adding Washer Fluid” under *Windshield Washer Fluid on page 6-31.*

When you open the hood on the 4.4L V8 XLR-V engine, here is what you will see:

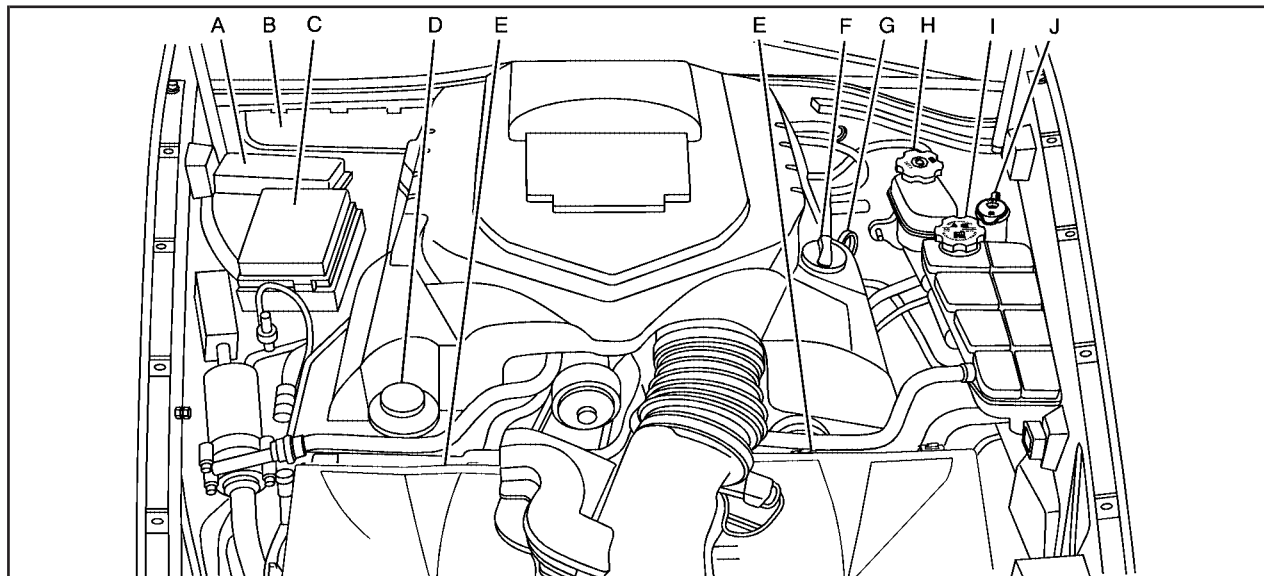

- A. Battery. See *Battery on page 6-35*.
- B. Passenger Compartment Air Filter. See *Passenger Compartment Air Filter on page 3-41*.
- C. Underhood Fuse Block. See *Underhood Fuse Block on page 6-87*.
- D. Power Steering Fluid. See *Power Steering Fluid on page 6-30*.
- E. Engine Air Cleaner/Filter. See *Engine Air Cleaner/Filter on page 6-20*.
- F. Engine Oil Fill Cap. See “When to Add Engine Oil” under *Engine Oil on page 6-15*.
- G. Engine Oil Dipstick. See “Checking Engine Oil” under *Engine Oil on page 6-15*.
- H. Brake Master Cylinder Reservoir. See “Brake Fluid” under *Brakes on page 6-32*.
- I. Engine Coolant Surge Tank and Pressure Cap. See *Cooling System on page 6-22*.
- J. Windshield Washer Fluid Reservoir. See “Adding Washer Fluid” under *Windshield Washer Fluid on page 6-31*.

## Engine Oil

If the LOW OIL LEVEL or LOW OIL PRESSURE message on the Driver Information Center (DIC) appears, check the engine oil level right away. For more information, see LOW OIL LEVEL and LOW OIL PRESSURE under *DIC Warnings and Messages on page 3-60*. Check the engine oil level regularly; this is an added reminder.

## Checking Engine Oil

It is a good idea to check the engine oil every time you get fuel. In order to get an accurate reading, the oil must be warm and the vehicle must be on level ground.

The engine oil dipstick handle is a yellow loop. See *Engine Compartment Overview on page 6-12* for the location of the engine oil dipstick.

1. Turn off the engine and give the oil several minutes to drain back into the oil pan. If you do not do this, the oil dipstick might not show the actual level.
2. Pull out the dipstick and clean it with a paper towel or cloth, then push it back in all the way. Remove it again, keeping the tip down, and check the level.

## When to Add Engine Oil

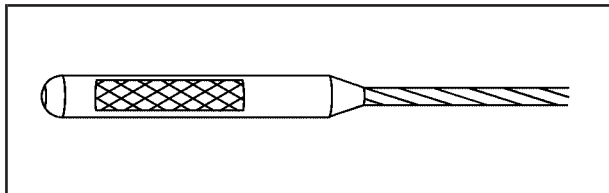

If the oil is below the cross-hatched area at the tip of the dipstick, add at least one quart/liter of the recommended oil. This section explains what kind of oil to use. For engine oil crankcase capacity, see *Capacities and Specifications* on page 6-90.

**Notice:** Do not add too much oil. If the engine has so much oil that the oil level gets above the cross-hatched area that shows the proper operating range, the engine could be damaged.

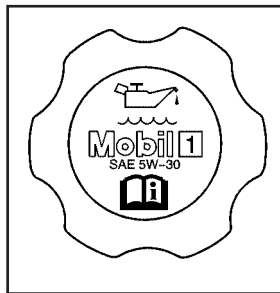

See *Engine Compartment Overview* on page 6-12 for the location of the engine oil fill cap.

Add enough oil to put the level somewhere in the proper operating range. Push the dipstick all the way back in when you are through.



## What Kind of Engine Oil to Use

Look for three things:

RECOMMENDED SAE VISCOSITY GRADE ENGINE OILS

HOT WEATHER

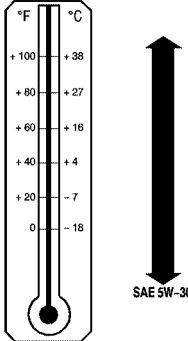

LOOK FOR THIS SYMBOL AND GM STANDARD GM4718M



DO NOT USE SAE 10W-40, SAE 20W-50 OR ANY OTHER VISCOSITY GRADE OIL NOT RECOMMENDED

SAE 5W-30

COLD WEATHER

- GM4718M

This vehicle's engine requires a special oil meeting GM Standard GM4718M. Oils meeting this standard may be identified as synthetic. However, not all synthetic oils will meet this GM standard. Use only an oil that meets GM Standard GM4718M.

**Notice:** Using oils that do not have the GM4718M Standard designation can cause engine damage not covered by the vehicle warranty.

- SAE 5W-30  
SAE 5W-30 is best for the vehicle. These numbers on an oil container show its viscosity, or thickness. Do not use other viscosity oils such as SAE 20W-50.
- American Petroleum Institute (API) starburst symbol

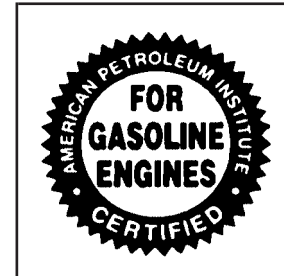

Oils meeting these requirements should have the starburst symbol on the container. This symbol indicates that the oil has been certified by the American Petroleum Institute (API).

This vehicle's engine was filled at the factory with a Mobil 1<sup>®</sup> synthetic oil meeting all requirements for this vehicle.

**Substitute Engine Oil:** When adding oil to maintain engine oil level, oil meeting GM Standard GM4718M might not be available. You can add substitute oil designated SAE 5W-30 with the starburst symbol at all temperatures. Substitute oil not meeting GM Standard GM4718M should not be used for an oil change.

## Engine Oil Additives / Engine Oil Flushes

Do not add anything to the oil. The recommended oils with the starburst symbol that meet GM Standard GM4718M are all you need for good performance and engine protection.

Engine oil system flushes are not recommended and could cause engine damage not covered by the vehicle warranty.

## Engine Oil Life System

### When to Change Engine Oil

This vehicle has a computer system that lets you know when to change the engine oil and filter. This is based on engine revolutions and engine temperature, and not on mileage. Based on driving conditions, the mileage at which an oil change will be indicated can vary considerably. For the oil life system to work properly, you must reset the system every time the oil is changed.

**Notice:** If this vehicle is an XLR-V model, the engine uses a special oil filter. The use of any other engine oil filter could lead to filter failure and result in severe engine damage. Damage caused by use of the wrong engine oil filter would not be covered by the vehicle warranty.

When the system has calculated that oil life has been diminished, it will indicate that an oil change is necessary. A CHANGE OIL NOW message in the DIC will come on. See *DIC Warnings and Messages on page 3-60*. Change the oil as soon as possible within the next 600 miles (1 000 km). It is possible that, if you are driving under the best conditions, the oil life system might not indicate that an oil change is necessary for over a year. However, the engine oil and filter must be changed at least once a year and at this time the system must be reset. Your dealer/retailer has trained service people who will perform this work using genuine parts and reset the system. It is also important to check the oil regularly and keep it at the proper level.

If the system is ever reset accidentally, you must change the oil at 3,000 miles (5 000 km) since the last oil change. Remember to reset the oil life system whenever the oil is changed.

## How to Reset the Engine Oil Life System and the Oil Life Indicator

The Engine Oil Life System calculates when to change the engine oil and filter based on vehicle use. Whenever the oil is changed, reset the system so it can calculate when the next oil change is required. If a situation occurs where you change the oil prior to a CHANGE OIL NOW message in the DIC being turned on, reset the system.

After the oil has been changed, the CHANGE OIL NOW message and the oil life indicator must be reset. To reset the message:

1. Press the up or down arrow to scroll the DIC to show OIL LIFE.
2. Once the XXX% ENGINE OIL LIFE menu item is highlighted, press and hold the RESET button until the percentage shows 100%.

If the percentage does not return to 100% or if the CHANGE OIL NOW message comes back on when you start the vehicle, the engine oil life system has not reset. Repeat the procedure.

## What to Do with Used Oil

Used engine oil contains certain elements that can be unhealthy for your skin and could even cause cancer. Do not let used oil stay on your skin for very long. Clean your skin and nails with soap and water, or a good hand cleaner. Wash or properly dispose of clothing or rags containing used engine oil. See the manufacturer's warnings about the use and disposal of oil products.

Used oil can be a threat to the environment. If you change your own oil, be sure to drain all the oil from the filter before disposal. Never dispose of oil by putting it in the trash, pouring it on the ground, into sewers, or into streams or bodies of water. Recycle it by taking it to a place that collects used oil.

## Engine Air Cleaner/Filter

See *Engine Compartment Overview* on page 6-12 for the location of the engine air cleaner/filters.

**Notice:** If you spray water into the engine air cleaner/filter intake and water enters the engine air cleaner/filter housing, you could damage your vehicle's engine. The repairs would not be covered by your warranty. Do not spray water into the engine air cleaner/filter intake and/or housing.

### When to Inspect the Engine Air Cleaner/Filters

Inspect the air cleaner/filters at the Maintenance II intervals and replace them at the first oil change after each 50,000 mile (80 000 km) interval. See *Scheduled Maintenance* on page 7-4 for more information. If you are driving in dusty/dirty conditions, inspect the filters at each engine oil change.

### How to Inspect the Engine Air Cleaner/Filters

To inspect the air cleaner/filters, remove the filters from the vehicle and lightly shake the filters to release loose dust and dirt. If the filters remain caked with dirt, new filters are required.

To inspect or replace the filters:

1. Some XLR-V vehicles, have a single piece black cover that snaps over the entire air cleaner assembly. For vehicles with this cover, simply pull it's left/right sides toward the outside of the vehicle and lift up to remove cover. Reinstall the cover when you are finished inspecting/replacing the filters.

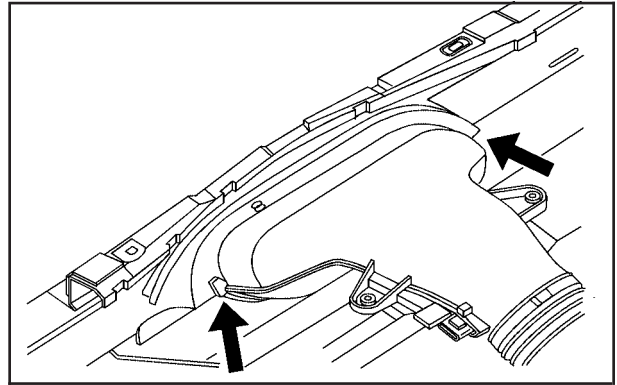

2. For vehicles that do not have a single piece black cover, move the clasps on the top of the engine air cleaner/filter cover forward to unlatch the cover.
3. Lift the front of the cover at an angle and remove. This is necessary due to the four tabs located on the rear of the cover.

4. Remove the engine air cleaner/filter and any loose debris that might be found in the air cleaner base.
5. Inspect or replace the filter.
6. Repeat the procedure for the second air cleaner/filter.

Reverse the procedure to reinstall the engine air cleaner/filter.

### CAUTION:

Operating the engine with the air cleaner/filter off can cause you or others to be burned. The air cleaner not only cleans the air; it helps to stop flames if the engine backfires. If it is not there and the engine backfires, you could be burned. Do not drive with it off, and be careful working on the engine with the air cleaner/filter off.

**Notice:** If the air cleaner/filter is off, a backfire can cause a damaging engine fire. And, dirt can easily get into the engine, which will damage it. Always have the air cleaner/filter in place when you are driving.

## Automatic Transmission Fluid

### How to Check Automatic Transmission Fluid

It is not necessary to check the transmission fluid level. A transmission fluid leak is the only reason for fluid loss. If a leak occurs, take the vehicle to the dealer/retailer service department and have it repaired as soon as possible.

There is a special procedure for checking and changing the transmission fluid. Because this procedure is difficult, you should have this done at the dealer/retailer service department. Contact your dealer/retailer for additional information or the procedure can be found in the service manual. To purchase a service manual, see *Service Publications Ordering Information on page 8-15*.

**Notice:** Use of the incorrect automatic transmission fluid may damage the vehicle, and the damages may not be covered by the vehicle's warranty. Always use the automatic transmission fluid listed in *Recommended Fluids and Lubricants on page 7-11*.

Change the fluid and filter at the intervals listed in *Additional Required Services on page 7-6*, and be sure to use the fluid listed in *Recommended Fluids and Lubricants on page 7-11*.

## Cooling System

The cooling system allows the engine to maintain the correct working temperature.

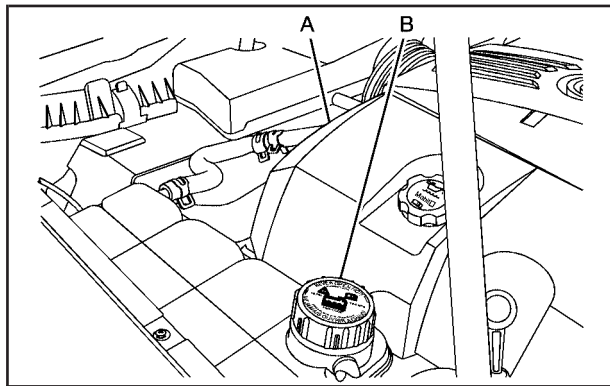

- A. Electric Engine Cooling Fan
- B. Coolant Surge Tank with Pressure Cap

### ⚠ CAUTION:

An electric engine cooling fan under the hood can start up even when the engine is not running and can cause injury. Keep hands, clothing, and tools away from any underhood electric fan.

### ⚠ CAUTION:

Heater and radiator hoses, and other engine parts, can be very hot. Do not touch them. If you do, you can be burned.

Do not run the engine if there is a leak. If you run the engine, it could lose all coolant. That could cause an engine fire, and you could be burned. Get any leak fixed before you drive the vehicle.

**Notice:** Using coolant other than DEX-COOL<sup>®</sup> can cause premature engine, heater core, or radiator corrosion. In addition, the engine coolant could require changing sooner, at 30,000 miles (50 000 km) or 24 months, whichever occurs first. Any repairs would not be covered by the vehicle warranty. Always use DEX-COOL<sup>®</sup> (silicate-free) coolant in the vehicle.

## Engine Coolant

The cooling system in the vehicle is filled with DEX-COOL<sup>®</sup> engine coolant. This coolant is designed to remain in the vehicle for five years or 150,000 miles (240 000 km), whichever occurs first.

The following explains the cooling system and how to check and add coolant when it is low. If there is a problem with the engine overheating, see *Engine Overheating on page 6-27*.

### What to Use

#### CAUTION:

Adding only plain water to the cooling system can be dangerous. Plain water, or some other liquid such as alcohol, can boil before the proper coolant mixture will. The vehicle's coolant warning system is set for the proper coolant mixture. With plain water or the wrong mixture, the engine could get too hot but you would not get the overheat warning. The engine could catch fire and you or others could be burned. Use a 50/50 mixture of clean, drinkable water and DEX-COOL<sup>®</sup> coolant.

Use a 50/50 mixture of clean, drinkable water and DEX-COOL<sup>®</sup> coolant. If using this mixture, nothing else needs to be added. This mixture:

- Gives freezing protection down to  $-34^{\circ}\text{F}$  ( $-37^{\circ}\text{C}$ ), outside temperature.
- Gives boiling protection up to  $265^{\circ}\text{F}$  ( $129^{\circ}\text{C}$ ), engine temperature.
- Protects against rust and corrosion.
- Will not damage aluminum parts.
- Helps keep the proper engine temperature.

**Notice:** If an improper coolant mixture is used, the engine could overheat and be badly damaged. The repair cost would not be covered by the vehicle warranty. Too much water in the mixture can freeze and crack the engine, radiator, heater core, and other parts.

**Notice:** If extra inhibitors and/or additives are used in the vehicle's cooling system, the vehicle could be damaged. Use only the proper mixture of the engine coolant listed in this manual for the cooling system. See *Recommended Fluids and Lubricants on page 7-11* for more information.

## Checking Coolant

The vehicle must be on a level surface when checking the coolant level.

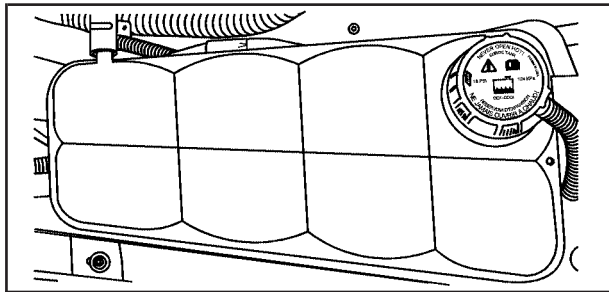

The engine coolant surge tank is located toward the rear of the engine compartment on the driver side of the vehicle. For more information on location, see *Engine Compartment Overview* on page 6-12.

Check to see if coolant is visible in the coolant surge tank. If the coolant inside the coolant surge tank is boiling, do not do anything else until it cools down. If coolant is visible but the coolant level is not at or above the FULL COLD mark, add a 50/50 mixture of clean, drinkable water and DEX-COOL<sup>®</sup> coolant at the coolant surge tank, but be sure the cooling system is cool before this is done.

When the engine is cold, the coolant level should be at or above the FULL COLD mark on the side of the coolant surge tank that faces the front. When the engine is hot, the level could be higher than the FULL COLD mark.

If the coolant is below the FULL COLD mark when the engine is hot, there could be a leak in the cooling system.

If the LOW COOLANT message on the Driver Information Center (DIC) comes on and stays on, it means the vehicle is low on engine coolant. See *DIC Warnings and Messages* on page 3-60. A low coolant level should be indicated by a LOW COOLANT message on the Driver Information Center (DIC). If it is, there could be a leak in the cooling system.

## How to Add Coolant to the Coolant Surge Tank

### CAUTION:

You can be burned if you spill coolant on hot engine parts. Coolant contains ethylene glycol and it will burn if the engine parts are hot enough. Do not spill coolant on a hot engine.



**Notice:** This vehicle has a specific coolant fill procedure. Failure to follow this procedure could cause the engine to overheat and be severely damaged.

**⚠ CAUTION:**

An electric engine cooling fan under the hood can start up even when the engine is not running and can cause injury. Keep hands, clothing, and tools away from any underhood electric fan.

**⚠ CAUTION:**

Steam and scalding liquids from a hot cooling system can blow out and burn you badly. They are under pressure, and if you turn the coolant surge tank pressure cap — even a little — they can come out at high speed. Never turn the cap when the cooling system, including the coolant surge tank pressure cap, is hot. Wait for the cooling system and coolant surge tank pressure cap to cool if you ever have to turn the pressure cap.

If no coolant is visible in the coolant surge tank, add coolant as follows:

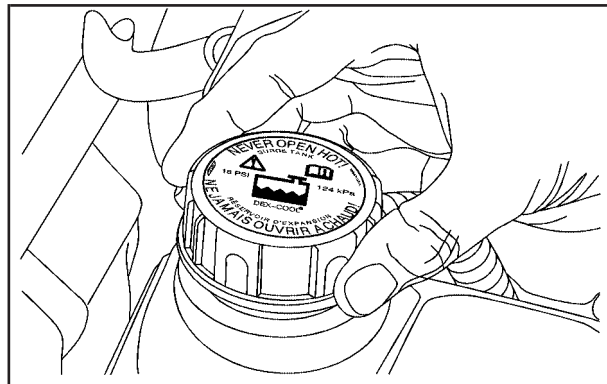

1. You can remove the coolant surge tank pressure cap when the cooling system, including the coolant surge tank pressure cap and upper radiator hose, is no longer hot. Turn the pressure cap slowly counterclockwise.  
If you hear a hiss, wait for that to stop. A hiss means there is still some pressure left.
2. Then keep turning the cap and remove it.

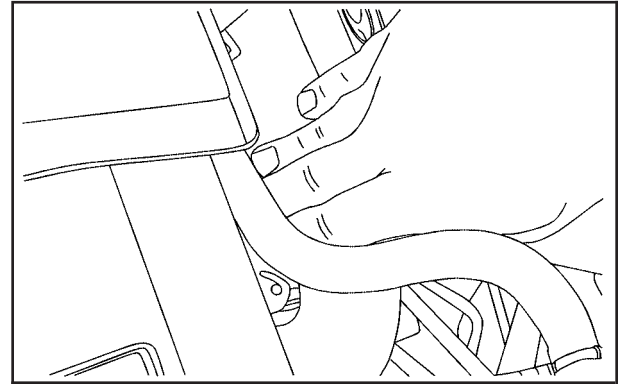
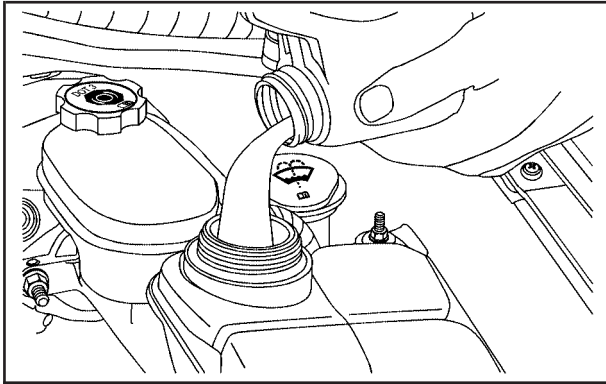

3. Fill the coolant surge tank with the proper mixture until the level inside the coolant surge tank stabilizes at the FULL COLD mark on the front of the coolant surge tank.

4. With the coolant surge tank pressure cap off, start the engine and let it run until you can feel the upper radiator hose getting hot. Watch out for the engine cooling fan.

By this time, the coolant level inside the coolant surge tank may be lower. If the level is lower, add more of the proper mixture to the coolant surge tank until the level stabilizes at the FULL COLD mark on the coolant surge tank.

5. Then replace the pressure cap. Be sure the cap is hand-tight and fully seated.

If the LOW COOLANT message does not appear on the Driver Information Center (DIC) after two minutes, the coolant is at the proper fill level. If a LOW COOLANT message does appear, repeat Steps 1 through 3 then reinstall the pressure cap, or see your dealer/retailer.

If coolant is needed, add the proper DEX-COOL<sup>®</sup> coolant mixture at the coolant surge tank.

**Notice:** If the pressure cap is not tightly installed, coolant loss and possible engine damage may occur. Be sure the cap is properly and tightly secured.

The coolant surge tank pressure cap must be fully installed on the coolant surge tank. See *Engine Compartment Overview on page 6-12* for more information on location.

## Engine Overheating

The vehicle has several indicators to warn of engine overheating.

There is a COOLANT OVER TEMP message or an ENGINE HOT, STOP ENGINE message displayed in the Driver Information Center (DIC). See *DIC Warnings and Messages on page 3-60*. You will also hear a chime.

There is also an engine coolant temperature gage on the instrument panel cluster. See *Engine Coolant Temperature Gage on page 3-49*.

You may decide not to lift the hood when this warning appears, but instead get service help right away. See *Roadside Service on page 8-7*.

If you do decide to lift the hood, make sure the vehicle is parked on a level surface.

Then check to see if the engine cooling fans are running. If the engine is overheating, both fans should be running. If they are not, do not continue to run the engine and have the vehicle serviced.

**Notice:** Engine damage from running the engine without coolant is not covered by the warranty.

**Notice:** If the engine catches fire while driving with no coolant, the vehicle can be badly damaged. The costly repairs would not be covered by the vehicle warranty. See *Overheated Engine Protection Operating Mode on page 6-29* for information on driving to a safe place in an emergency.

## If Steam Is Coming From The Engine Compartment

### CAUTION:

Steam from an overheated engine can burn you badly, even if you just open the hood. Stay away from the engine if you see or hear steam coming from it. Turn it off and get everyone away from the vehicle until it cools down. Wait until there is no sign of steam or coolant before you open the hood.

If you keep driving when the vehicles engine is overheated, the liquids in it can catch fire. You or others could be badly burned. Stop the engine if it overheats, and get out of the vehicle until the engine is cool.

See *Overheated Engine Protection Operating Mode* on page 6-29 for information on driving to a safe place in an emergency.

## If No Steam Is Coming From The Engine Compartment

An overheat warning, along with a low coolant message, can indicate a serious problem.

If an engine overheat warning is displayed with no low coolant message, but no steam can be seen or heard, the problem may not be too serious. Sometimes the engine can get a little too hot when the vehicle:

- Climbs a long hill on a hot day.
- Stops after high-speed driving.
- Idles for long periods in traffic.
- Tows a trailer.

If the overheat warning is displayed with no sign of steam, try this for a minute or so:

1. Turn the air conditioning off.
2. Turn the heater on to the highest temperature and to the highest fan speed. Open the windows as necessary.
3. In heavy traffic, let the engine idle in N (Neutral) while stopped. If it is safe to do so, pull off the road, shift to P (Park) or N (Neutral) and let the engine idle.

If the temperature overheat gage is no longer in the overheat zone or an overheat warning no longer displays, the vehicle can be driven. Continue to drive the vehicle slow for about 10 minutes. Keep a safe vehicle distance from the car in front of you. If the warning does not come back on, continue to drive normally.

If the warning continues, pull over, stop, and park the vehicle right away.

If there is no sign of steam, idle the engine for three minutes while parked. If the warning is still displayed, turn off the engine until it cools down. Also, see “Overheated Engine Protection Operating Mode” next in this section.

## Overheated Engine Protection Operating Mode

This operating mode allows the vehicle to be driven to a safe place in an emergency situation. If an overheated engine condition exists and the DIC message ENGINE HOT, STOP ENGINE is displayed, an overheat protection mode which alternates firing groups of cylinders helps prevent engine damage. In this mode, you will notice a significant loss in power and engine performance. Driving extended miles (km) in the overheat protection mode should be avoided.

**Notice:** After driving in the overheated engine protection operating mode, to avoid engine damage, allow the engine to cool before attempting any repair. The engine oil will be severely degraded. Repair the cause of coolant loss, change the oil and reset the oil life system. See *Engine Oil on page 6-15*.

## Power Steering Fluid

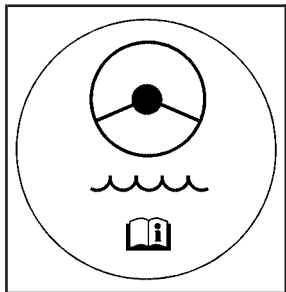

See *Engine Compartment Overview* on page 6-12 for reservoir location.

### When to Check Power Steering Fluid

It is not necessary to regularly check power steering fluid unless you suspect there is a leak in the system or you hear an unusual noise. A fluid loss in this system could indicate a problem. Have the system inspected and repaired.

## How to Check Power Steering Fluid

To check the power steering fluid:

1. Turn the ignition off and let the engine compartment cool down.
2. Wipe the cap and the top of the reservoir clean.
3. Unscrew the cap and wipe the dipstick with a clean rag.
4. Replace the cap and completely tighten it.
5. Remove the cap again and look at the fluid level on the dipstick.

The level should be at the FULL COLD mark. If necessary, add only enough fluid to bring the level up to the mark.

### What to Use

To determine what kind of fluid to use, see *Recommended Fluids and Lubricants* on page 7-11. Always use the proper fluid.

**Notice:** Use of the incorrect fluid may damage the vehicle and the damages may not be covered by the vehicle's warranty. Always use the correct fluid listed in *Recommended Fluids and Lubricants* on page 7-11.

# Windshield Washer Fluid

## What to Use

When you need windshield washer fluid, be sure to read the manufacturer's instructions before use. If you will be operating the vehicle in an area where the temperature may fall below freezing, use a fluid that has sufficient protection against freezing.

## Adding Washer Fluid

The LOW WASHER FLUID message will be displayed on the Driver Information Center (DIC) when the fluid is low.

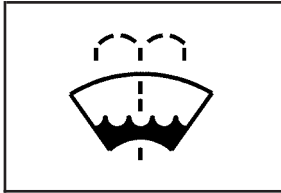

Open the cap with the washer symbol on it. Add washer fluid until the tank is full. See *Engine Compartment Overview* on page 6-12 for reservoir location.

### Notice:

- When using concentrated washer fluid, follow the manufacturer's instructions for adding water.
- Do not mix water with ready-to-use washer fluid. Water can cause the solution to freeze and damage your washer fluid tank and other parts of the washer system. Also, water does not clean as well as washer fluid.
- Fill the washer fluid tank only three-quarters full when it is very cold. This allows for fluid expansion if freezing occurs, which could damage the tank if it is completely full.
- Do not use engine coolant (antifreeze) in your windshield washer. It can damage the vehicle's windshield washer system and paint.

## Brakes

### Brake Fluid

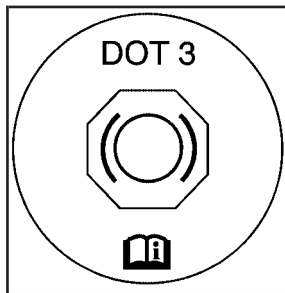

The brake master cylinder reservoir is filled with DOT-3 brake fluid. See *Engine Compartment Overview* on page 6-12 for the location of the reservoir.

There are only two reasons why the brake fluid level in the reservoir might go down:

- The brake fluid level goes down because of normal brake lining wear. When new linings are installed, the fluid level goes back up.
- A fluid leak in the brake hydraulic system can also cause a low fluid level. Have the brake hydraulic system fixed, since a leak means that sooner or later the brakes will not work well.

Do not top off the brake fluid. Adding fluid does not correct a leak. If fluid is added when the linings are worn, there will be too much fluid when new brake linings are installed. Add or remove brake fluid, as necessary, only when work is done on the brake hydraulic system.

#### CAUTION:

If too much brake fluid is added, it can spill on the engine and burn, if the engine is hot enough. You or others could be burned, and the vehicle could be damaged. Add brake fluid only when work is done on the brake hydraulic system. See "Checking Brake Fluid" in this section.

Refer to the Maintenance Schedule to determine when to check the brake fluid. See *Scheduled Maintenance* on page 7-4.



## Checking Brake Fluid

Check brake fluid by looking at the brake fluid reservoir. See *Engine Compartment Overview on page 6-12*.

The fluid level should be above the MIN mark on the reservoir. If it is not, have the brake hydraulic system checked to see if there is a leak.

After work is done on the brake hydraulic system, make sure the level is between the MIN and MAX marks.

### What to Add

Use only new DOT-3 brake fluid from a sealed container. See *Recommended Fluids and Lubricants on page 7-11*.

Always clean the brake fluid reservoir cap and the area around the cap before removing it. This helps keep dirt from entering the reservoir.

### CAUTION:

With the wrong kind of fluid in the brake hydraulic system, the brakes might not work well. This could cause a crash. Always use the proper brake fluid.

#### Notice:

- **Using the wrong fluid can badly damage brake hydraulic system parts. For example, just a few drops of mineral-based oil, such as engine oil, in the brake hydraulic system can damage brake hydraulic system parts so badly that they will have to be replaced. Do not let someone put in the wrong kind of fluid.**
- **If brake fluid is spilled on the vehicle's painted surfaces, the paint finish can be damaged. Be careful not to spill brake fluid on the vehicle. If you do, wash it off immediately. See *Washing Your Vehicle on page 6-77*.**

## Brake Wear

This vehicle has disc brakes. Disc brake pads have built-in wear indicators that make a high-pitched warning sound when the brake pads are worn and new pads are needed. The sound can come and go or be heard all the time the vehicle is moving, except when applying the brake pedal firmly.

### CAUTION:

The brake wear warning sound means that soon the brakes will not work well. That could lead to an accident. When the brake wear warning sound is heard, have the vehicle serviced.

**Notice:** Continuing to drive with worn-out brake pads could result in costly brake repair.

Some driving conditions or climates can cause a brake squeal when the brakes are first applied or lightly applied. This does not mean something is wrong with the brakes.

Brake linings should always be replaced as complete axle sets.

## Brake Pedal Travel

See your dealer/retailer if the brake pedal does not return to normal height, or if there is a rapid increase in pedal travel. This could be a sign that brake service might be required.

## Brake Adjustment

Every brake stop, the disc brakes automatically adjust for wear.

## Replacing Brake System Parts

The braking system on a vehicle is complex. Its many parts have to be of top quality and work well together if the vehicle is to have really good braking. The vehicle was designed and tested with top-quality brake parts. When parts of the braking system are replaced — for example, when the brake linings wear down and new ones are installed — be sure to get new approved replacement parts. If this is not done, the brakes might not work properly. For example, if someone puts in brake linings that are wrong for the vehicle, the balance between the front and rear brakes can change — for the worse. The braking performance expected can change in many other ways if the wrong replacement brake parts are installed.

## Battery

This vehicle has a maintenance free battery. When it is time for a new battery, see your dealer/retailer for one that has the replacement number shown on the original battery's label.

For battery replacement, see your dealer/retailer or the service manual. To purchase a service manual, see *Service Publications Ordering Information on page 8-15*.

**Warning:** Battery posts, terminals, and related accessories contain lead and lead compounds, chemicals known to the State of California to cause cancer and reproductive harm. Wash hands after handling.

## Vehicle Storage

### CAUTION:

Batteries have acid that can burn you and gas that can explode. You can be badly hurt if you are not careful. See *Jump Starting on page 6-36* for tips on working around a battery without getting hurt.

**Infrequent Usage:** If the vehicle is driven infrequently, remove the black, negative (–) cable from the battery. This helps keep the battery from running down.

See “Power Window Initialization” in *Power Windows on page 2-18*.

**Extended Storage:** For extended storage of the vehicle, remove the black, negative (–) cable from the battery or use a battery trickle charger. This helps maintain the charge of the battery over an extended period of time.

All doors and the trunk must be closed before reconnecting the battery. After reconnecting the battery, press the unlock button on the keyless access transmitter. Failure to follow this procedure could result in the alarm sounding. Pressing unlock on the keyless access transmitter will stop the alarm.

## Jump Starting

If the vehicle’s battery has run down, you may want to use another vehicle and some jumper cables to start your vehicle. Be sure to use the following steps to do it safely.

### CAUTION:

Batteries can hurt you. They can be dangerous because:

- They contain acid that can burn you.
- They contain gas that can explode or ignite.
- They contain enough electricity to burn you.

If you do not follow these steps exactly, some or all of these things can hurt you.

**Notice:** If you try to start your vehicle by pushing or pulling it, you could damage your vehicle. Do not push or pull your vehicle to start it; instead, use the jump starting procedure in this manual to start your vehicle when the battery has run down.

1. Check the other vehicle. It must have a 12-volt battery with a negative ground system.

**Notice:** If the other vehicle's system is not a 12-volt system with a negative ground, both vehicles can be damaged. Only use vehicles with 12-volt systems with negative grounds to jump start your vehicle.

2. Get the vehicles close enough so the jumper cables can reach, but be sure the vehicles are not touching each other. If they are, it could cause a ground connection you do not want. You would not be able to start your vehicle, and the bad grounding could damage the electrical systems.

To avoid the possibility of the vehicles rolling, set the parking brake firmly on both vehicles involved in the jump start procedure. Put an automatic transmission in P (Park) or a manual transmission in NEUTRAL before setting the parking brake.

**Notice:** If you leave the radio or other accessories on during the jump starting procedure, they could be damaged. The repairs would not be covered by the warranty. Always turn off the radio and other accessories when jump starting the vehicle.

3. Turn off the ignition on both vehicles. Unplug unnecessary accessories plugged into the cigarette lighter or the accessory power outlet. Turn off the radio and all lamps that are not needed. This will avoid sparks and help save both batteries. And it could save the radio!
4. Open the hoods and locate the batteries. Find the positive (+) and negative (-) terminal locations on each vehicle. See *Engine Compartment Overview on page 6-12* for more information on location.

 **CAUTION:**

An electric fan can start up even when the engine is not running and can injure you. Keep hands, clothing and tools away from any underhood electric fan.

 **CAUTION:**

Using a match near a battery can cause battery gas to explode. People have been hurt doing this, and some have been blinded. Use a flashlight if you need more light.

Be sure the battery has enough water. You do not need to add water to the battery installed in your new vehicle. But if a battery has filler caps, be sure the right amount of fluid is there. If it is low, add water to take care of that first. If you do not, explosive gas could be present.

Battery fluid contains acid that can burn you. Do not get it on you. If you accidentally get it in your eyes or on your skin, flush the place with water and get medical help immediately.

 **CAUTION:**

Fans or other moving engine parts can injure you badly. Keep your hands away from moving parts once the engine is running.

5. Check that the jumper cables do not have loose or missing insulation. If they do, you could get a shock. The vehicles could be damaged too.

Before you connect the cables, here are some basic things you should know. Positive (+) will go to positive (+) or to a remote positive (+) terminal if the vehicle has one. Negative (-) will go to a heavy, unpainted metal engine part or to a remote negative (-) terminal if the vehicle has one.

Do not connect positive (+) to negative (-) or you will get a short that would damage the battery and maybe other parts too. And do not connect the negative (-) cable to the negative (-) terminal on the dead battery because this can cause sparks.

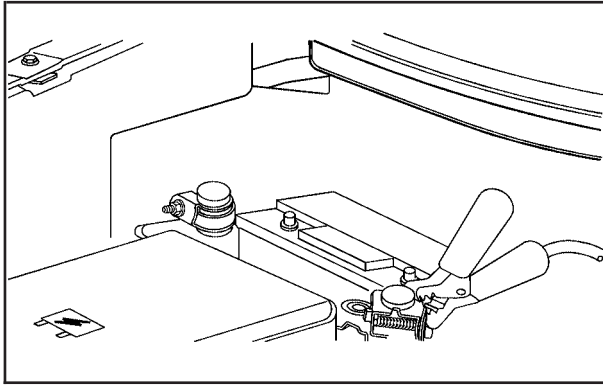

6. Connect the red positive (+) cable to the positive (+) terminal of the dead battery. Use a remote positive (+) terminal if the vehicle has one.
7. Do not let the other end touch metal. Connect it to the positive (+) terminal of the good battery. Use a remote positive (+) terminal if the vehicle has one.

8. Now connect the black negative (-) cable to the negative (-) terminal of the good battery. Use a remote negative (-) terminal if the vehicle has one.

Do not let the other end touch anything until the next step. The other end of the negative (-) cable does not go to the dead battery. It goes to a heavy, unpainted metal engine part or to a remote negative (-) terminal on the vehicle with the dead battery.

9. Connect the other end of the negative (-) cable at least 18 inches (45 cm) away from the dead battery, but not near engine parts that move. The electrical connection is just as good there, and the chance of sparks getting back to the battery is much less.
10. Now start the vehicle with the good battery and run the engine for a while.
11. Try to start the vehicle that had the dead battery. If it will not start after a few tries, it probably needs service.

**Notice:** If the jumper cables are connected or removed in the wrong order, electrical shorting may occur and damage the vehicle. The repairs would not be covered by your warranty. Always connect and remove the jumper cables in the correct order, making sure that the cables do not touch each other or other metal.

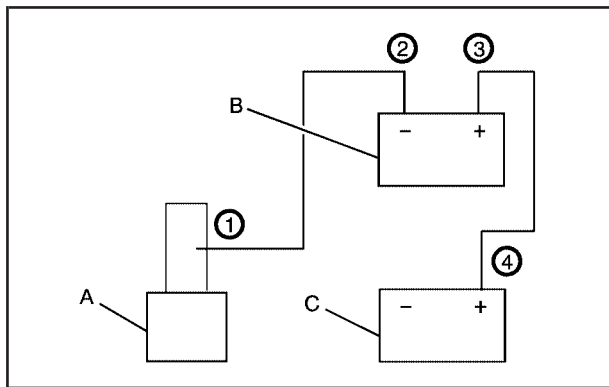

**Jumper Cable Removal**

- A. Heavy, Unpainted Metal Engine Part
- B. Good Battery
- C. Dead Battery

To disconnect the jumper cables from both vehicles, do the following:

1. Disconnect the black negative (-) cable from the vehicle that had the dead battery.
2. Disconnect the black negative (-) cable from the vehicle with the good battery.
3. Disconnect the red positive (+) cable from the vehicle with the good battery.
4. Disconnect the red positive (+) cable from the other vehicle.

Perform “Power Window Initialize” steps under *Power Windows on page 2-18*, if the vehicle has experienced power loss.



# Rear Axle

## When to Check Lubricant

It is not necessary to regularly check rear axle fluid unless you suspect there is a leak or you hear an unusual noise. A fluid loss could indicate a problem. Have it inspected and repaired.

## How to Check Lubricant

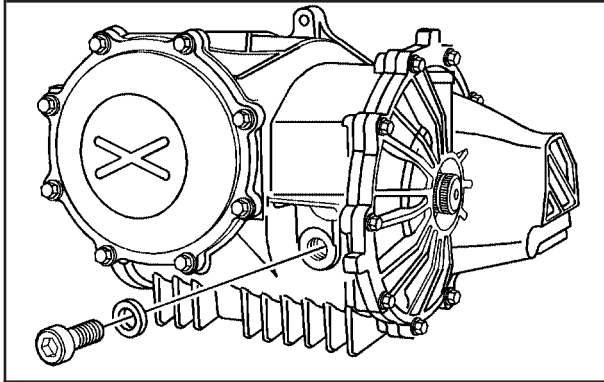

To get an accurate reading, the vehicle should be on a level surface.

If the level is below the bottom of the filler plug hole, you will need to add some lubricant. Add enough lubricant to raise the level to the bottom of the filler plug hole.

## What to Use

To add lubricant when the level is low, use Dexron LS Gear Oil or equivalent meeting GM Specification 9986115. To completely refill after draining, add 4.7 ounces (118 ml) of Limited-Slip Differential Lubricant Additive (GM Part No. 1052358) or equivalent. Then fill to the bottom of the filler plug hole with the Synthetic Gear Lubricant.

# Headlamp Aiming

The high intensity discharge (HID) visual optical aiming type headlamps have been preset at the factory and should need no further adjustment. If the headlamps need to be re-aimed, it is recommended to see your dealer/retailer for service. However, it is possible to re-aim the headlamps as described in the following procedure.

**Notice:** To make sure the headlamps are aimed properly, read all the instructions before beginning. Failure to follow these instructions could cause damage to headlamp parts.

The vehicle should be properly prepared as follows:

- The vehicle should be placed so the headlamps are 25 ft (7.6 m) from a light colored wall.
- The vehicle must have all four tires on a perfectly level surface which is level all the way to the wall.
- The vehicle should be placed so it is perpendicular to the wall.
- The vehicle should not have any snow, ice, or mud attached to it.

- The vehicle should be fully assembled all other work stopped while headlamp aiming is being done.
- The vehicle should be normally loaded with a full tank of fuel and one person or 160 lbs (75 kg) on the driver seat.
- The tires should be properly inflated.
- Start the vehicle and rock it to level the suspension.

Headlamp aiming is done with the low-beam headlamps. The high-beam headlamps are correctly aimed if the low-beam headlamps are aimed properly.

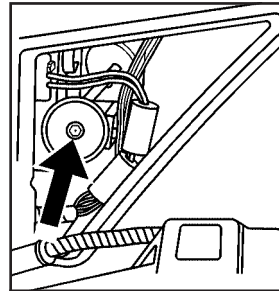

The headlamp aiming device is under the hood near the headlamps.

## Headlamp Vertical Aiming

To properly prepare the vehicle for vertical headlamp aiming, see *Headlamp Aiming on page 6-42* for more information.

**Notice:** Horizontal aiming must be performed before making any adjustments to the vertical aim. Adjusting the vertical aim first will result in an incorrect headlamp aim.

To adjust the vertical aim:

1. Open the hood. See *Hood Release on page 6-11* for more information.
2. Locate the aim dot on the inner projector lens of the low-beam headlamp.
3. Measure the distance from the ground to the aim dot on each low-beam headlamp. Record this distance.

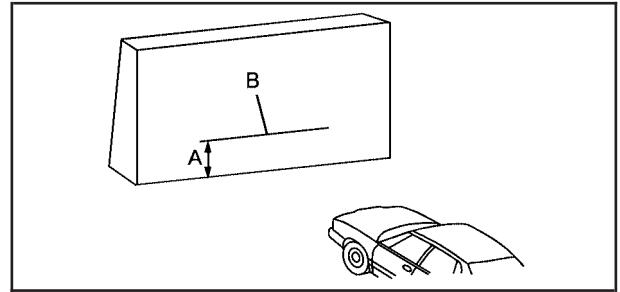

4. At the wall or other flat surface, measure from the ground upward (A) to the recorded distance from Step 3 and mark it.

**Notice:** Do not cover a headlamp to improve beam cut-off when aiming. Covering a headlamp may cause excessive heat build-up which may cause damage to the headlamp.

5. Draw or tape a horizontal line (B) on the wall or flat surface the width of the vehicle at the height of the mark in Step 4.
6. Turn on the low-beam headlamps and place a piece of cardboard in front of the headlamp not being aimed. This should allow only the beam of light from the headlamp being aimed to be seen on the flat surface.

7. Locate the vertical headlamp aiming screws, which are under the hood near each headlamp assembly. The adjustment screw can be turned with a 6 mm male hex.

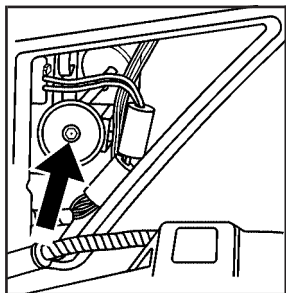

8. Turn the vertical aiming screw until the headlamp beam is aimed to the horizontal tape line.

9. The top edge of the cut-off should be positioned at the bottom edge of the horizontal tape line.

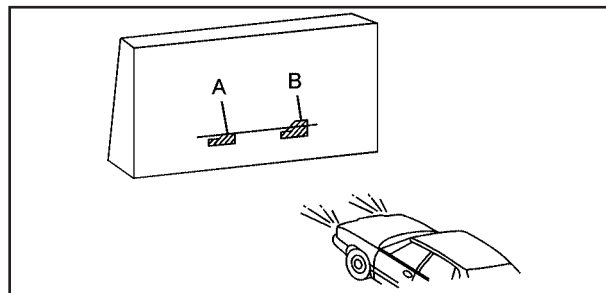

10. Make sure that the light from the headlamp is positioned at the bottom edge of the horizontal tape line. The lamp on the left (A) shows the correct headlamp aim. The lamp on the right (B) shows the incorrect headlamp aim.
11. Repeat Steps 7 through 9 for the opposite headlamp.

## Bulb Replacement

It is recommended that all bulbs be replaced by your dealer/retailer.

## Windshield Replacement

The windshield is part of the Head-Up Display (HUD) system. If you ever have to get the windshield replaced, get one that is designed for HUD or the HUD image may look out of focus.

## Windshield Wiper Blade Replacement

Windshield wiper blades should be inspected for wear and cracking. See *Scheduled Maintenance on page 7-4* for more information.

Replacement blades come in different types and are removed in different ways. For proper type and length, see *Maintenance Replacement Parts on page 7-13*.

To replace the windshield wiper blade assembly:

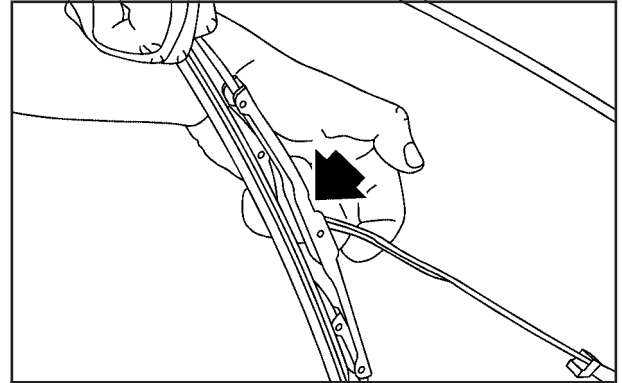

1. Lift the wiper arm away from the windshield.

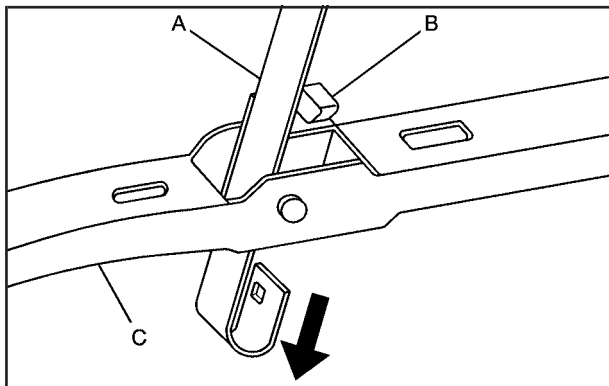

2. Push the release lever (B) to disengage the hook and push the wiper arm (A) out of the blade (C).
3. Push the new wiper blade securely on the wiper arm until you hear the release lever click into place.

## Tires

Your new vehicle comes with high-quality tires made by a leading tire manufacturer. If you ever have questions about your tire warranty and where to obtain service, see your vehicle warranty booklet for details. For additional information refer to the tire manufacturer.

### CAUTION:

Poorly maintained and improperly used tires are dangerous.

- Overloading your vehicle's tires can cause overheating as a result of too much flexing. You could have an air-out and a serious accident. See *Loading the Vehicle on page 5-21*.
- Underinflated tires pose the same danger as overloaded tires. The resulting accident could cause serious injury. Check all tires frequently to maintain the recommended pressure. Tire pressure should be checked when your vehicle's tires are cold. See *Inflation - Tire Pressure on page 6-54*.
- Overinflated tires are more likely to be cut, punctured, or broken by a sudden impact — such as when you hit a pothole. Keep tires at the recommended pressure.
- Worn, old tires can cause accidents. If the tire's tread is badly worn, or if your vehicle's tires have been damaged, replace them.

## Low-Profile Tires (XLR-V)

If your vehicle has P235/45R19 or P255/40R19 size tires, they are classified as low-profile tires. These tires are designed for very responsive driving on wet or dry pavement. You may also notice more road noise with low-profile performance tires and that they tend to wear faster.

**Notice:** If the vehicle has low-profile tires, they are more susceptible to damage from road hazards or curb impact than standard profile tires. Tire and/or wheel assembly damage can occur when coming into contact with road hazards like, potholes, or sharp edged objects, or when sliding into a curb. The vehicle warranty does not cover this type of damage. Keep tires set to the correct inflation pressure and, when possible avoid contact with curbs, potholes, and other road hazards.

## Winter Tires (XLR-V)

If you expect to drive on snow or ice covered roads often, you may want to get winter tires for your vehicle. All season tires provide good overall performance on most surfaces but they may not offer the traction you would like or the same level of performance as winter tires on snow or ice covered roads.

Winter tires, in general, are designed for increased traction on snow and ice covered roads. With winter tires, there may be decreased dry road traction, increased road noise, and shorter tread life. After switching to winter tires, be alert for changes in vehicle handling and braking.

See your dealer for details regarding winter tire availability and proper tire selection. Also, see *Buying New Tires on page 6-62*.

If you choose to use winter tires:

- Use tires of the same brand and tread type on all four wheel positions.
- Use only radial ply tires of the same size, load range, and speed rating as the original equipment tires.

Winter tires with the same speed rating as your original equipment tires may not be available for H, V, W, Y, and ZR speed rated tires. If you choose winter tires with a lower speed rating, never exceed the tire's maximum speed capability.

## Tire Sidewall Labeling

Useful information about a tire is molded into its sidewall. The example below shows a typical passenger (p-metric) tire sidewall.

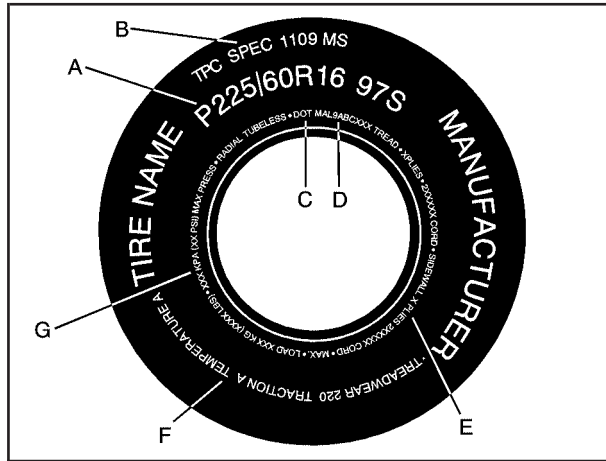

Passenger (P-Metric) Tire Example

**(A) Tire Size:** The tire size is a combination of letters and numbers used to define a particular tire's width, height, aspect ratio, construction type, and service description. See the "Tire Size" illustration later in this section for more detail.

**(B) TPC Spec (Tire Performance Criteria Specification):** Original equipment tires designed to GM's specific tire performance criteria have a TPC specification code molded onto the sidewall. GM's TPC specifications meet or exceed all federal safety guidelines.

**(C) DOT (Department of Transportation):** The Department of Transportation (DOT) code indicates that the tire is in compliance with the U.S. Department of Transportation Motor Vehicle Safety Standards.

**(D) Tire Identification Number (TIN):** The letters and numbers following DOT code are the Tire Identification Number (TIN). The TIN shows the manufacturer and plant code, tire size, and date the tire was manufactured. The TIN is molded onto both sides of the tire, although only one side may have the date of manufacture.

**(E) Tire Ply Material:** The type of cord and number of plies in the sidewall and under the tread.



**(F) Uniform Tire Quality Grading (UTQG):**

Tire manufacturers are required to grade tires based on three performance factors: treadwear, traction and temperature resistance. For more information see *Uniform Tire Quality Grading on page 6-64*.

**(G) Maximum Cold Inflation Load Limit:**

Maximum load that can be carried and the maximum pressure needed to support that load.

**Tire Size**

The following illustration shows an example of a typical passenger (p-metric) vehicle tire size.

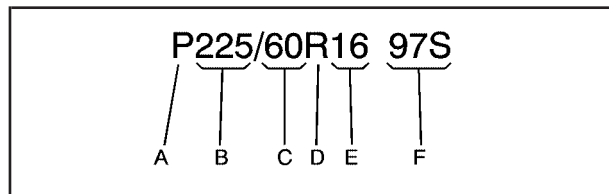

**(A) Passenger (P-Metric) Tire:** The United States version of a metric tire sizing system. The letter P as the first character in the tire size means a passenger vehicle tire engineered to standards set by the U. S. Tire and Rim Association.

**(B) Tire Width:** The three-digit number indicates the tire section width in millimeters from sidewall to sidewall.

**(C) Aspect Ratio:** A two-digit number that indicates the tire height-to-width measurements. For example, if the tire size aspect ratio is 60, as shown in item C of the illustration, it would mean that the tire's sidewall is 60 percent as high as it is wide.

**(D) Construction Code:** A letter code is used to indicate the type of ply construction in the tire. The letter R means radial ply construction; the letter D means diagonal or bias ply construction; and the letter B means belted-bias ply construction.

**(E) Rim Diameter:** Diameter of the wheel in inches.

**(F) Service Description:** These characters represent the load range and speed rating of the tire. The load index represents the load carry capacity a tire is certified to carry. The load index can range from 1 to 279. The speed rating is the maximum speed a tire is certified to carry a load. Speed ratings range from A to Z.

## Tire Terminology and Definitions

**Air Pressure:** The amount of air inside the tire pressing outward on each square inch of the tire. Air pressure is expressed in pounds per square inch (psi) or kilopascal (kPa).

**Accessory Weight:** This means the combined weight of optional accessories. Some examples of optional accessories are, automatic transmission, power steering, power brakes, power windows, power seats, and air conditioning.

**Aspect Ratio:** The relationship of a tire's height to its width.

**Belt:** A rubber coated layer of cords that is located between the plies and the tread. Cords may be made from steel or other reinforcing materials.

**Bead:** The tire bead contains steel wires wrapped by steel cords that hold the tire onto the rim.

**Bias Ply Tire:** A pneumatic tire in which the plies are laid at alternate angles less than 90 degrees to the centerline of the tread.

**Cold Tire Pressure:** The amount of air pressure in a tire, measured in pounds per square inch (psi) or kilopascals (kPa) before a tire has built up heat from driving. See *Inflation - Tire Pressure on page 6-54*.

**Curb Weight:** The weight of a motor vehicle with standard and optional equipment including the maximum capacity of fuel, oil, and coolant, but without passengers and cargo.

**DOT Markings:** A code molded into the sidewall of a tire signifying that the tire is in compliance with the U.S. Department of Transportation (DOT) motor vehicle safety standards. The DOT code includes the Tire Identification Number (TIN), an alphanumeric designator which can also identify the tire manufacturer, production plant, brand, and date of production.

**GVWR:** Gross Vehicle Weight Rating. See *Loading the Vehicle on page 5-21*.

**GAWR FRT:** Gross Axle Weight Rating for the front axle. See *Loading the Vehicle on page 5-21*.

**GAWR RR:** Gross Axle Weight Rating for the rear axle. See *Loading the Vehicle on page 5-21*.

**Intended Outboard Sidewall:** The side of an asymmetrical tire, that must always face outward when mounted on a vehicle.

**Kilopascal (kPa):** The metric unit for air pressure.

**Light Truck (LT-Metric) Tire:** A tire used on light duty trucks and some multipurpose passenger vehicles.

**Load Index:** An assigned number ranging from 1 to 279 that corresponds to the load carrying capacity of a tire.

**Maximum Inflation Pressure:** The maximum air pressure to which a cold tire can be inflated. The maximum air pressure is molded onto the sidewall.

**Maximum Load Rating:** The load rating for a tire at the maximum permissible inflation pressure for that tire.

**Maximum Loaded Vehicle Weight:** The sum of curb weight, accessory weight, vehicle capacity weight, and production options weight.

**Normal Occupant Weight:** The number of occupants a vehicle is designed to seat multiplied by 150 lbs (68 kg). See *Loading the Vehicle on page 5-21*.

**Occupant Distribution:** Designated seating positions.

**Outward Facing Sidewall:** The side of an asymmetrical tire that has a particular side that faces outward when mounted on a vehicle. The side of the tire that contains a whitewall, bears white lettering, or bears manufacturer, brand, and/or model name molding that is higher or deeper than the same moldings on the other sidewall of the tire.

**Passenger (P-Metric) Tire:** A tire used on passenger cars and some light duty trucks and multipurpose vehicles.

**Recommended Inflation Pressure:** Vehicle manufacturer's recommended tire inflation pressure as shown on the tire placard. See *Inflation - Tire Pressure on page 6-54* and *Loading the Vehicle on page 5-21*.

**Radial Ply Tire:** A pneumatic tire in which the ply cords that extend to the beads are laid at 90 degrees to the centerline of the tread.

**Rim:** A metal support for a tire and upon which the tire beads are seated.

**Sidewall:** The portion of a tire between the tread and the bead.

**Speed Rating:** An alphanumeric code assigned to a tire indicating the maximum speed at which a tire can operate.

**Traction:** The friction between the tire and the road surface. The amount of grip provided.

**Tread:** The portion of a tire that comes into contact with the road.

**Treadwear Indicators:** Narrow bands, sometimes called wear bars, that show across the tread of a tire when only 1/16 inch (1.6 mm) of tread remains. See *When It Is Time for New Tires on page 6-61*.

**UTQGS (Uniform Tire Quality Grading Standards):** A tire information system that provides consumers with ratings for a tire's traction, temperature, and treadwear. Ratings are determined by tire manufacturers using government testing procedures. The ratings are molded into the sidewall of the tire. See *Uniform Tire Quality Grading on page 6-64*.

**Vehicle Capacity Weight:** The number of designated seating positions multiplied by 150 lbs (68 kg) plus the rated cargo load. See *Loading the Vehicle on page 5-21*.

**Vehicle Maximum Load on the Tire:** Load on an individual tire due to curb weight, accessory weight, occupant weight, and cargo weight.

**Vehicle Placard:** A label permanently attached to a vehicle showing the vehicle's capacity weight and the original equipment tire size and recommended inflation pressure. See "Tire and Loading Information Label" under *Loading the Vehicle on page 5-21*.

## Run-Flat Tires

Your vehicle, when new, had run-flat tires. There is no spare tire, no tire changing equipment, and no place to store a tire in the vehicle. Run-flat tires perform so well without any air that a Tire Pressure Monitor System (TPMS) is used to alert you if a tire has lost pressure.

### CAUTION:

When the low tire warning light is displayed on the instrument panel cluster, your vehicle's handling capabilities will be reduced during severe maneuvers. If you drive too fast, you could lose control of your vehicle. You or others could be injured. Do not drive over 55 mph (90 km/h) when the low tire warning light is displayed. Drive cautiously and check your tire pressures as soon as you can.

If a tire goes flat, you will not need to stop on the side of the road to change the tire. You can just keep on driving. The shorter the distance you drive and the slower the speed, the greater the chance that the tire will not have to be replaced. If you drive on a deflated run-flat tire for 25 miles (40 km) or less and at speeds of 55 mph (90 km/h) or less, there is a good chance that the tire can be repaired. The tire can operate effectively with no air pressure for up to 100 miles (160 km) at speeds up to 55 mph (90 km/h), but the tire would then have to be replaced. When a tire is filled with air, it provides a cushion between the road and the wheel. Because you will not have this cushion when driving on a deflated tire, try to avoid potholes that could damage your wheel and require replacement of it.

Some road hazards can damage a tire beyond repair. This damage could occur even before you have driven on the tire in a deflated condition. When a tire has been damaged, or if you have driven any distance on a run-flat tire, check with an authorized run-flat tire service center to determine whether the tire can be repaired or should be replaced. To maintain your vehicle's run-flat feature, all replacement tires must be self-supporting tires. As soon as possible, contact the nearest authorized GM or run-flat servicing facility for inspection and repair or

replacement. To locate the nearest GM or run-flat servicing facility, call Roadside Assistance. For phone numbers and Roadside Service details see *Roadside Service on page 8-7*.

### CAUTION:

Run-flat tires are constructed differently than other tires and could explode during improper service. You or others could be injured or killed if you attempt to repair, replace, dismount, or mount a run-flat tire. Let only an authorized run-flat service center repair, replace, dismount, and mount run-flat tires.

The valve stems on your run-flat tires have sensors that are part of the Tire Pressure Monitor System (TPMS). See *Tire Pressure Monitor System on page 6-55*. These sensors contain batteries which are designed to last for 10 years under normal driving conditions. See your dealer/retailer if you ever need to have a wheel replaced, or if the sensors ever need replacement.

## Inflation - Tire Pressure

Tires need the correct amount of air pressure to operate effectively.

**Notice:** Do not let anyone tell you that under-inflation or over-inflation is all right. It is not. If your tires do not have enough air (under-inflation), you can get the following:

- Too much flexing
- Too much heat
- Tire overloading
- Premature or irregular wear
- Poor handling
- Reduced fuel economy

If your tires have too much air (over-inflation), you can get the following:

- Unusual wear
- Poor handling
- Rough ride
- Needless damage from road hazards

A vehicle specific Tire and Loading Information label is attached to your vehicle. This label shows your vehicle's original equipment tires and the correct inflation pressures for your tires when they are cold. The recommended cold tire inflation pressure, shown on the label, is the minimum amount of air pressure needed to support your vehicle's maximum load carrying capacity.

For additional information regarding how much weight your vehicle can carry, and an example of the Tire and Loading Information label, see *Loading the Vehicle on page 5-21*. How you load your vehicle affects vehicle handling and ride comfort. Never load your vehicle with more weight than it was designed to carry.

## **When to Check**

Check your tires once a month or more.

## **How to Check**

Use a good quality pocket-type gage to check tire pressure. You cannot tell if your tires are properly inflated simply by looking at them. Radial tires may look properly inflated even when they are under-inflated. Check the tire's inflation pressure when the tires are cold. Cold means your vehicle has been sitting for at least three hours or driven no more than 1 mile (1.6 km).

Remove the valve cap from the tire valve stem. Press the tire gage firmly onto the valve to get a pressure measurement. If the cold tire inflation pressure matches the recommended pressure on the Tire and Loading Information label, no further adjustment is necessary. If the inflation pressure is low, add air until you reach the recommended amount.

If you overfill the tire, release air by pushing on the metal stem in the center of the tire valve. Re-check the tire pressure with the tire gage.

Be sure to put the valve caps back on the valve stems. They help prevent leaks by keeping out dirt and moisture.

## **Tire Pressure Monitor System**

The Tire Pressure Monitor System (TPMS) uses radio and sensor technology to check tire pressure levels. The TPMS sensors monitor the air pressure in your vehicle's tires and transmit tire pressure readings to a receiver located in the vehicle.

Each tire, including the spare (if provided), should be checked monthly when cold and inflated to the inflation pressure recommended by the vehicle manufacturer on the vehicle placard or tire inflation pressure label. (If your vehicle has tires of a different size than the size indicated on the vehicle placard or tire inflation pressure label, you should determine the proper tire inflation pressure for those tires.)

As an added safety feature, your vehicle has been equipped with a tire pressure monitoring system (TPMS) that illuminates a low tire pressure telltale when one or more of your tires is significantly under-inflated.

Accordingly, when the low tire pressure telltale illuminates, you should stop and check your tires as soon as possible, and inflate them to the proper pressure. Driving on a significantly under-inflated tire causes the tire to overheat and can lead to tire failure. Under-inflation also reduces fuel efficiency and tire tread life, and may affect the vehicle's handling and stopping ability.

Please note that the TPMS is not a substitute for proper tire maintenance, and it is the driver's responsibility to maintain correct tire pressure, even if under-inflation has not reached the level to trigger illumination of the TPMS low tire pressure telltale.

Your vehicle has also been equipped with a TPMS malfunction indicator to indicate when the system is not operating properly. The TPMS malfunction indicator is

combined with the low tire pressure telltale. When the system detects a malfunction, the telltale will flash for approximately one minute and then remain continuously illuminated. This sequence will continue upon subsequent vehicle start-ups as long as the malfunction exists.

When the malfunction indicator is illuminated, the system may not be able to detect or signal low tire pressure as intended. TPMS malfunctions may occur for a variety of reasons, including the installation of replacement or alternate tires or wheels on the vehicle that prevent the TPMS from functioning properly. Always check the TPMS malfunction telltale after replacing one or more tires or wheels on your vehicle to ensure that the replacement or alternate tires and wheels allow the TPMS to continue to function properly.

See *Tire Pressure Monitor Operation* on page 6-57 for additional information.



## Federal Communications Commission (FCC) and Industry and Science Canada

The Tire Pressure Monitor System (TPMS) operates on a radio frequency and complies with Part 15 of the FCC Rules. Operation is subject to the following two conditions:

1. This device may not cause harmful interference.
2. This device must accept any interference received, including interference that may cause undesired operation.

The TPMS operates on a radio frequency and complies with RSS-210 of Industry and Science Canada.

Operation is subject to the following two conditions:

1. This device may not cause interference.
2. This device must accept any interference received, including interference that may cause undesired operation of the device.

Changes or modifications to this system by other than an authorized service facility could void authorization to use this equipment.

## Tire Pressure Monitor Operation

This vehicle may have a Tire Pressure Monitor System (TPMS). The TPMS is designed to warn the driver when a low tire pressure condition exists. TPMS sensors are mounted onto each tire and wheel assembly on your vehicle. The TPMS sensors monitor the air pressure in the vehicle's tires and transmits the tire pressure readings to a receiver located in the vehicle.

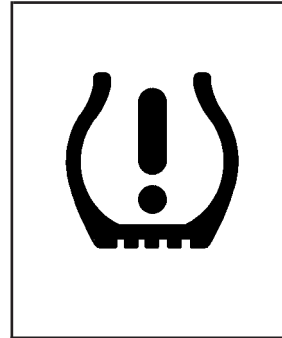

When a low tire pressure condition is detected, the TPMS illuminates the low tire pressure warning light, located in the instrument panel cluster.

At the same time a message to check the pressure in a specific tire appears on the Driver Information Center (DIC) display. The low tire pressure warning light and the DIC warning message appear at each ignition cycle until the tires are inflated to the correct inflation pressure. Using the DIC, tire pressure levels can be viewed by the driver. For additional information and details about the DIC operation and displays see *DIC Operation and Displays on page 3-57* and *DIC Warnings and Messages on page 3-60*.

The low tire pressure warning light may come on in cool weather when the vehicle is first started, and then turn off as you start to drive. This could be an early indicator that the air pressure in the tire(s) are getting low and need to be inflated to the proper pressure.

A Tire and Loading Information label, attached to your vehicle, shows the size of your vehicle's original equipment tires and the correct inflation pressure for your vehicle's tires when they are cold. See *Loading the Vehicle on page 5-21*, for an example of the Tire and Loading Information label and its location on your vehicle. Also see *Inflation - Tire Pressure on page 6-54* for additional information.

Your vehicle's TPMS can warn you about a low tire pressure condition but it does not replace normal tire maintenance. See *Tire Inspection and Rotation on page 6-60*, *When It Is Time for New Tires on page 6-61*, and *Tires on page 6-46*.

**Notice:** Liquid tire sealants could damage the Tire Pressure Monitor System (TPMS) sensors. Sensor damage caused by using a tire sealant is not covered by your warranty. Do not use liquid tire sealants.

## TPMS Malfunction Light and Message

The TPMS will not function properly if one or more of the TPMS sensors are missing or inoperable. When the system detects a malfunction, the low tire warning light flashes for about one minute and then stays on for the remainder of the ignition cycle. A DIC warning message is also displayed. The low tire warning light and DIC warning message come on at each ignition cycle until the problem is corrected. Some of the conditions that can cause the malfunction light and DIC message to come on are:

- The TPMS sensor matching process was not done or not completed successfully. The DIC message should go off after successfully completing the sensor matching process.
- One or more TPMS sensors are missing or damaged. Under these conditions the TPMS malfunction light (low tire warning light) comes on, and at the same time the DIC message is displayed. The DIC message and TPMS malfunction light should go off once the TPMS sensors are installed and the sensor matching process is performed successfully.

- Replacement tires or wheels do not match your vehicle's original equipment tires or wheels. Tires and wheels other than those recommended for your vehicle could prevent the TPMS from functioning properly. See *Buying New Tires* on page 6-62.
- Operating electronic devices or being near facilities using radio wave frequencies similar to the TPMS could cause the TPMS sensors to malfunction.

If the TPMS is not functioning it cannot detect or signal a low tire condition. See your dealer/retailer for service if the TPMS malfunction light and DIC message comes on and stays on.

## TPMS Sensor Matching Process

Each TPMS sensor has a unique identification code. Any time you replace one or more of the TPMS sensors or rotate your vehicle's tires, the identification codes will need to be matched to the new tire/wheel position. The sensors are matched to the tire/wheel positions in the following order: driver side front tire, passenger side front tire, passenger side rear tire, and driver side rear tire using a TPMS diagnostic tool. See your dealer/retailer for service.

## Tire Inspection and Rotation

We recommend that you regularly inspect your vehicle's tires for signs of wear or damage. See *When It Is Time for New Tires* on page 6-61 for additional information.

If your vehicle has P235/50R18 size tires they should be rotated any time you notice unusual wear. Rotate the tires as soon as possible and check wheel alignment. Also check for damaged tires or wheels. See *When It Is Time for New Tires* on page 6-61 and *Wheel Replacement* on page 6-66.

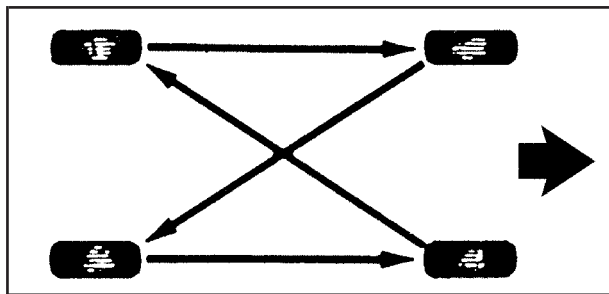

When rotating P235/50R18 size tires, always use the correct rotation pattern shown here.

After the tires have been rotated, adjust the front and rear inflation pressures as shown on the Tire and Loading Information label, see *Inflation - Tire Pressure* on page 6-54 and *Loading the Vehicle* on page 5-21. Vehicles that have the Tire Pressure Monitor System (TPMS) need the TPMS sensors reset after a tire rotation is performed. A special tool is needed to reset the sensor identification codes. See your dealer/retailer for service. Make certain that all wheel nuts are properly tightened. See *Wheel Replacement* on page 6-66 and "Wheel Nut Torque" under *Capacities and Specifications* on page 6-90.

### CAUTION:

Rust or dirt on a wheel, or on the parts to which it is fastened, can make wheel nuts become loose after a time. The wheel could come off and cause a crash. When you change a wheel, remove any rust or dirt from places where the wheel attaches to the vehicle. In an emergency, you can use a cloth or a paper towel to do this; but be sure to use a scraper or wire brush later, if you need to, to get all the rust or dirt off.

## XLR-V Tires

Tire rotation is not recommended if your vehicle has P235/45R19 size tires on the front axle and P255/40R19 size tires on the rear axle. Different tire sizes front to rear should not be rotated.

## When It Is Time for New Tires

Various factors, such as maintenance, temperatures, driving speeds, vehicle loading, and road conditions influence when you need new tires.

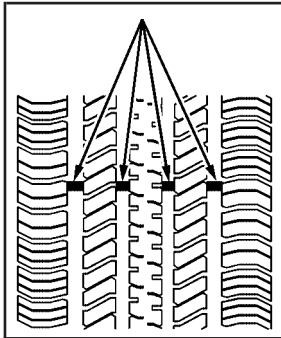

One way to tell when it is time for new tires is to check the treadwear indicators, which will appear when your tires have only 1/16 inch (1.6 mm) or less of tread remaining.

You need new tires if any of the following statements are true:

- You can see the indicators at three or more places around the tire.
- You can see cord or fabric showing through the tire's rubber.
- The tread or sidewall is cracked, cut, or snagged deep enough to show cord or fabric.
- The tire has a bump, bulge, or split.
- The tire has a puncture, cut, or other damage that cannot be repaired well because of the size or location of the damage.

The rubber in tires degrades over time, even if they are not being used. This is also true for the spare tire, if your vehicle has one. Multiple conditions affect how fast this aging takes place, including temperatures, loading conditions, and inflation pressure maintenance. With proper care and maintenance tires will typically wear out before they degrade due to age. If you are unsure about the need to replace your tires as they get older, consult the tire manufacturer for more information.

## Buying New Tires

GM has developed and matched specific tires for your vehicle. The original equipment tires installed on your vehicle, when it was new, were designed to meet General Motors Tire Performance Criteria Specification (TPC Spec) system rating. If you need replacement tires, GM strongly recommends that you get tires with the same TPC Spec rating. This way, your vehicle will continue to have tires that are designed to give the same performance and vehicle safety, during normal use, as the original tires.

GM's exclusive TPC Spec system considers over a dozen critical specifications that impact the overall performance of your vehicle, including brake system performance, ride and handling, traction control, and tire pressure monitoring performance. GM's TPC Spec number is molded onto the tire's sidewall near the tire size. If the tires have an all-season tread design, the TPC Spec number will be followed by an MS for mud and snow. See *Tire Sidewall Labeling on page 6-48*, for additional information.

GM recommends replacing tires in sets of four. This is because uniform tread depth on all tires will help keep your vehicle performing most like it did when the

tires were new. Replacing less than a full set of tires can affect the braking and handling performance of your vehicle. See *Tire Inspection and Rotation on page 6-60*.

Winter tires with the same speed rating as your original equipment tires may not be available for H, V, W, Y and ZR speed rated tires. If you choose snow tires with a lower speed rating, never exceed the tire's maximum speed capability.

### CAUTION:

Mixing tires could cause you to lose control while driving. If you mix tires of different sizes (other than those originally installed on your vehicle), brands, or types (radial and bias-belted tires), the vehicle may not handle properly, and you could have a crash. Using tires of different sizes (other than those originally installed on your vehicle), brands or types, may also cause damage to your vehicle. Be sure to use the correct size, brand, and type tires on all four wheels.

 **CAUTION:**

If you use bias-ply tires on the vehicle, the wheel rim flanges could develop cracks after many miles of driving. A tire and/or wheel could fail suddenly, causing a crash. Use only radial-ply tires with the wheels on the vehicle.

If you must replace your vehicle's tires with those that do not have a TPC Spec number, make sure they are the same size, load range, speed rating, and construction type (radial and bias-belted tires) as your vehicle's original tires.

Vehicles that have a tire pressure monitoring system could give an inaccurate low-pressure warning if non-TPC Spec rated tires are installed on it. Non-TPC Spec rated tires may give a low-pressure warning that is higher or lower than the proper warning level you would get with TPC Spec rated tires. See *Tire Pressure Monitor System on page 6-55*.

Your vehicle's original equipment tires are listed on the Tire and Loading Information label. See *Loading the Vehicle on page 5-21*, for more information about the Tire and Loading Information label and its location on your vehicle.

## Different Size Tires and Wheels

If you add wheels or tires that are a different size than your original equipment wheels and tires, this may affect the way your vehicle performs, including its braking, ride and handling characteristics, stability, and resistance to rollover. Additionally, if your vehicle has electronic systems such as, antilock brakes, traction control, and electronic stability control, the performance of these systems can be affected.

 **CAUTION:**

If you add different sized wheels, your vehicle may not provide an acceptable level of performance and safety if tires not recommended for those wheels are selected. You may increase the chance that you will crash and suffer serious injury. Only use GM specific wheel and tire systems developed for your vehicle, and have them properly installed by a GM certified technician.

See *Buying New Tires on page 6-62* and *Accessories and Modifications on page 6-3* for additional information.

## Uniform Tire Quality Grading

Quality grades can be found where applicable on the tire sidewall between tread shoulder and maximum section width. For example:

### **Treadwear 200 Traction AA Temperature A**

The following information relates to the system developed by the United States National Highway Traffic Safety Administration (NHTSA), which grades tires by treadwear, traction, and temperature performance. This applies only to vehicles sold in the United States. The grades are molded on the sidewalls of most passenger car tires. The Uniform Tire Quality Grading (UTQG) system does not apply to deep tread, winter-type snow tires, space-saver, or temporary use spare tires, tires with nominal rim diameters of 10 to 12 inches (25 to 30 cm), or to some limited-production tires.

While the tires available on General Motors passenger cars and light trucks may vary with respect to these grades, they must also conform to federal safety requirements and additional General Motors Tire Performance Criteria (TPC) standards.

## Treadwear

The treadwear grade is a comparative rating based on the wear rate of the tire when tested under controlled conditions on a specified government test course. For example, a tire graded 150 would wear one and a half (1.5) times as well on the government course as a tire graded 100. The relative performance of tires depends upon the actual conditions of their use, however, and may depart significantly from the norm due to variations in driving habits, service practices, and differences in road characteristics and climate.

### **Traction – AA, A, B, C**

The traction grades, from highest to lowest, are AA, A, B, and C. Those grades represent the tire's ability to stop on wet pavement as measured under controlled conditions on specified government test surfaces of asphalt and concrete. A tire marked C may have poor traction performance.



 **WARNING:**

The traction grade assigned to this tire is based on straight-ahead braking traction tests, and does not include acceleration, cornering, hydroplaning, or peak traction characteristics.

## Temperature – A, B, C

The temperature grades are A (the highest), B, and C, representing the tire's resistance to the generation of heat and its ability to dissipate heat when tested under controlled conditions on a specified indoor laboratory test wheel. Sustained high temperature can cause the material of the tire to degenerate and reduce tire life, and excessive temperature can lead to sudden tire failure. The grade C corresponds to a level of performance which all passenger car tires must meet under the Federal Motor Vehicle Safety Standard No. 109. Grades B and A represent higher levels of performance on the laboratory test wheel than the minimum required by law.

 **WARNING:**

The temperature grade for this tire is established for a tire that is properly inflated and not overloaded. Excessive speed, underinflation, or excessive loading, either separately or in combination, can cause heat buildup and possible tire failure.

## Wheel Alignment and Tire Balance

The tires and wheels on your vehicle were aligned and balanced carefully at the factory to give you the longest tire life and best overall performance. Adjustments to wheel alignment and tire balancing will not be necessary on a regular basis. However, if you notice unusual tire wear or your vehicle pulling to one side or the other, the alignment might need to be checked. If you notice your vehicle vibrating when driving on a smooth road, the tires and wheels might need to be rebalanced. See your dealer/retailer for proper diagnosis.

## Wheel Replacement

Replace any wheel that is bent, cracked, or badly rusted or corroded. If wheel nuts keep coming loose, the wheel, wheel bolts, and wheel nuts should be replaced. If the wheel leaks air, replace it (except some aluminum wheels, which can sometimes be repaired). See your dealer/retailer if any of these conditions exist.

Your dealer/retailer will know the kind of wheel you need.

Each new wheel should have the same load-carrying capacity, diameter, width, offset, and be mounted the same way as the one it replaces.

If you need to replace any of your wheels, wheel bolts or wheel nuts, replace them only with new GM original equipment parts. This way, you will be sure to have the right wheel, wheel bolts, and wheel nuts for your vehicle.

### CAUTION:

Using the wrong replacement wheels, wheel bolts, or wheel nuts on your vehicle can be dangerous. It could affect the braking and handling of your

CAUTION: (Continued)

### CAUTION: (Continued)

vehicle, make your tires lose air and make you lose control. You could have a collision in which you or others could be injured. Always use the correct wheel, wheel bolts, and wheel nuts for replacement.

### CAUTION:

Putting a used wheel on the vehicle is dangerous. You cannot know how it has been used or how far it has been driven. It could fail suddenly and cause a crash. If you have to replace a wheel, use a new GM original equipment wheel.

**Notice:** The wrong wheel can also cause problems with bearing life, brake cooling, speedometer or odometer calibration, headlamp aim, bumper height, vehicle ground clearance, and tire clearance to the body and chassis.

**⚠ CAUTION:**

Rust or dirt on a wheel, or on the parts to which it is fastened, can make wheel nuts become loose after a time. The wheel could come off and cause a crash. When you change a wheel, remove any rust or dirt from places where the wheel attaches to the vehicle. In an emergency, you can use a cloth or a paper towel to do this; but be sure to use a scraper or wire brush later, if you need to, to get all the rust or dirt off.

## Tightening Wheel Lug Nuts

**⚠ CAUTION:**

Never use oil or grease on studs or the threads of the wheel nuts. If you do, the wheel nuts might come loose and the wheel could fall off, causing a crash.

**⚠ CAUTION:**

Incorrect wheel nuts or improperly tightened wheel nuts can cause the wheel to become loose and even come off. This could lead to a crash. Be sure to use the correct wheel nuts. If you have to replace them, be sure to get new GM original equipment wheel nuts.

**Notice:** Improperly tightened wheel nuts can lead to brake pulsation and rotor damage. To avoid expensive brake repairs, evenly tighten the wheel nuts in the proper sequence and to the proper torque specification.

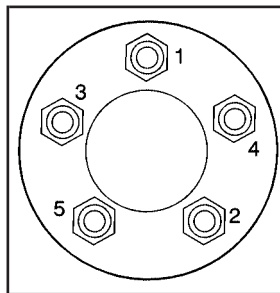

Tighten the wheel lug nuts firmly in a crisscross sequence as shown.

## Tire Chains

### CAUTION:

Do not use tire chains. There is not enough clearance. Tire chains used on a vehicle without the proper amount of clearance can cause damage to the brakes, suspension, or other vehicle parts. The area damaged by the tire chains could cause you to lose control of the vehicle and you or others may be injured in a crash. Use another type of traction device only if its manufacturer recommends it for use on the vehicle and tire size combination and road conditions. Follow that manufacturer's instructions. To help avoid damage to the vehicle, drive slowly, re-adjust or remove the device if it is contacting the vehicle, and do not spin the wheels. If you do find traction devices that will fit, install them on the rear tires.

## Lifting the Vehicle

### CAUTION:

Lifting a vehicle can cause an injury. The vehicle can slip off the jack and roll over you or others. You and they could be badly injured. Find a level place to lift the vehicle. To help prevent the vehicle from moving:

1. Firmly set the parking brake.
2. Put an automatic transmission shift lever in P (Park).
3. Turn the engine off.
4. Put blocks in front of and behind the wheels.

### CAUTION:

Getting under a vehicle when it is jacked up is dangerous. If the vehicle slips off the jack, you could be badly injured or killed. Never get under a vehicle when it is supported only by a jack.

## CAUTION:

Raising the vehicle with the jack improperly positioned can damage the vehicle or the vehicle may fall and cause your or others injury.

If you ever use a jack to lift the vehicle, follow the instructions that came with the jack, and be sure to use the correct lifting points to avoid damaging the vehicle.

**Notice:** Lifting the vehicle improperly can damage the vehicle and result in costly repairs not covered by the vehicle's warranty. To lift the vehicle properly, follow the advice in this part.

To help prevent vehicle damage:

- Be sure to place a block or pad between the jack and the vehicle.
- Make sure the jack you are using spans at least two crossmember ribs.
- Lift only in the areas shown in the following pictures.

For additional information, see your GM dealer and the Cadillac XLR service manual.

## Lifting From the Front

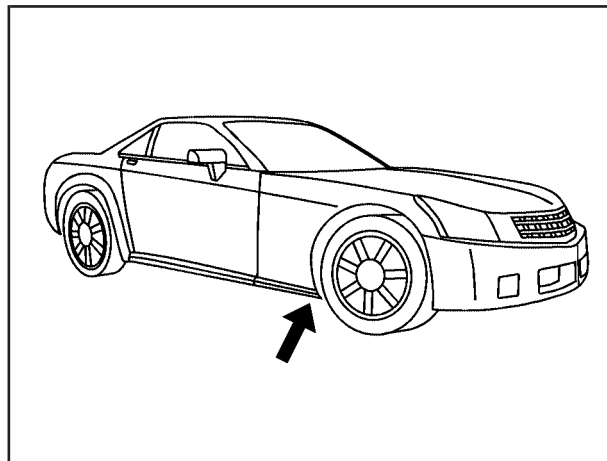

The front lifting points can be accessed from either side of the vehicle, behind the front tires.

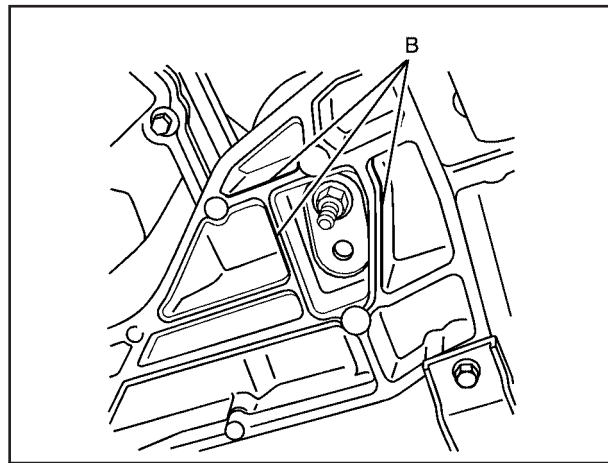
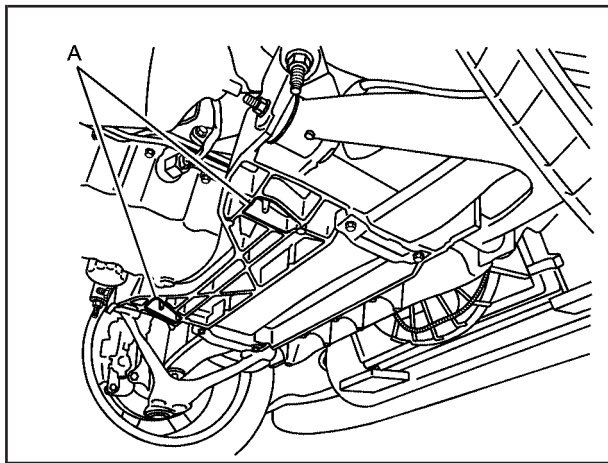

1. Locate the front lifting points (A), according to the illustration shown.
2. Be sure to place a block or pad between the jack and the vehicle.

3. Lift the vehicle with the jack, making sure the jack spans at least two of the crossmember ribs (B).

## Lifting From the Rear

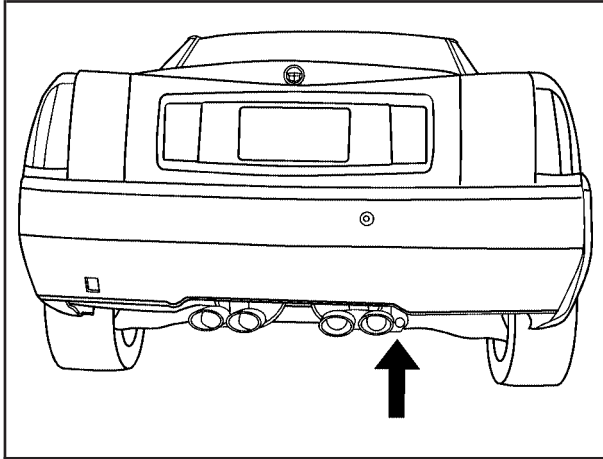

The rear lifting points can be accessed from the rear of the vehicle, on either the driver or passenger side.

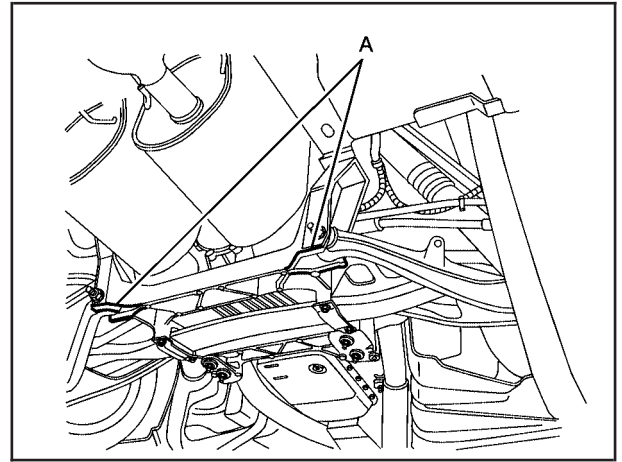

1. Locate the rear lifting points (A), according to the illustration shown.
2. Be sure to place a block or pad between the jack and the vehicle.

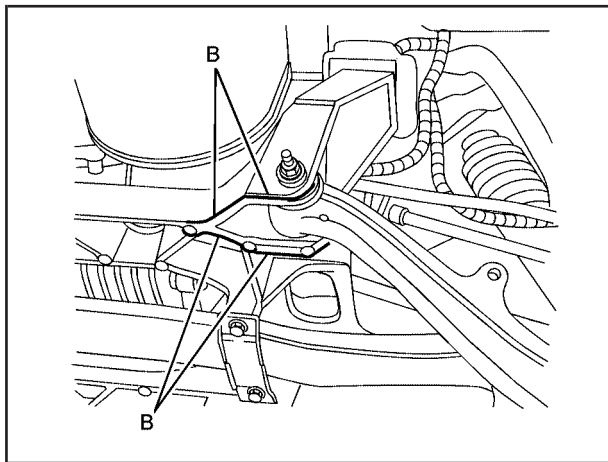

## If a Tire Goes Flat

It is unusual for a tire to blow out while you are driving, especially if you maintain the tires properly. If air goes out of a tire, it is much more likely to leak out slowly. See *Tires on page 6-46* for additional information.

This vehicle, when new, had run-flat tires. This type of tire can operate effectively with no air pressure, so you will not need to stop on the side of the road to change a flat tire. You can just keep on driving. The shorter the distance you drive and the slower the speed, the greater the chance that the run-flat tire will not have to be replaced. Run-flat tires perform so well without any air that a Tire Pressure Monitor (TPM) is used to alert you if a tire has lost pressure. See *Run-Flat Tires on page 6-52* and *Tire Pressure Monitor System on page 6-55*.

3. Lift the vehicle with the jack, making sure the jack spans at least two of the crossmember ribs (B).

For more information, see *Doing Your Own Service Work on page 6-4*.



 **CAUTION:**

When the TIRE FLAT MAX SPD 55, REDUCED HNDLG message is displayed on the Driver Information Center, the vehicle's handling capabilities will be reduced during severe maneuvers. If you drive too fast, you could lose control of the vehicle. You or others could be injured. Don't drive over 55 mph (90 km/h) when the TIRE FLAT MAX SPD 55, REDUCED HNDLG message is displayed. Drive cautiously and check the tire pressures as soon as you can.

If the TPM system detects a tire pressure below 5 psi (34 kPa), the TIRE FLAT MAX SPD 55, REDUCED HNDLG warning message is displayed on the Driver Information Center (DIC). See *DIC Operation and Displays on page 3-57* and *DIC Warnings and Messages on page 3-60* for information and details about the DIC operation and displays.

 **CAUTION:**

Special tools and procedures are required to service a run-flat tire. If these special tools and procedures are not used you or others could be injured and the vehicle could be damaged. Always be sure the proper tools and procedures, as described in the service manual, are used.

**Notice:** Using liquid sealants can damage the tire valves and tire pressure monitor sensors in the vehicle's run-flat tires. This damage would not be covered by warranty. Do not use liquid sealants in the vehicle's run-flat tires.

To order a service manual, see *Service Publications Ordering Information on page 8-15*.

If a tire goes flat, the stability control system will turn on automatically even if it was disabled by the driver. When a flat tire condition exists the StabiliTrak<sup>®</sup> system cannot be turned off. See *StabiliTrak<sup>®</sup> System on page 5-6*.

# Appearance Care

## Interior Cleaning

Your vehicle's interior will continue to look its best if it is cleaned often. Although not always visible, dust and dirt can accumulate on your upholstery. Dirt can damage carpet, fabric, leather, and plastic surfaces. Regular vacuuming is recommended to remove particles from your upholstery. It is important to keep your upholstery from becoming and remaining heavily soiled. Soils should be removed as quickly as possible. Your vehicle's interior may experience extremes of heat that could cause stains to set rapidly.

Lighter colored interiors may require more frequent cleaning. Use care because newspapers and garments that transfer color to your home furnishings may also transfer color to your vehicle's interior.

When cleaning your vehicle's interior, only use cleaners specifically designed for the surfaces being cleaned. Permanent damage may result from using cleaners on surfaces for which they were not intended. Use glass cleaner only on glass. Remove any accidental over-spray from other surfaces immediately. To prevent over-spray, apply cleaner directly to the cleaning cloth.

**Notice:** If you use abrasive cleaners when cleaning glass surfaces on your vehicle, you could scratch the glass and/or cause damage to the rear window defogger. When cleaning the glass on your vehicle, use only a soft cloth and glass cleaner.

Many cleaners contain solvents that may become concentrated in your vehicle's breathing space. Before using cleaners, read and adhere to all safety instructions on the label. While cleaning your vehicle's interior, maintain adequate ventilation by opening your vehicle's doors and windows.

Dust may be removed from small buttons and knobs using a small brush with soft bristles.

Your dealer/retailer has a product for cleaning your vehicle's glass. Should it become necessary, you can also obtain a product from your dealer/retailer to remove odors from your vehicle's upholstery.

Do not clean your vehicle using:

- A knife or any other sharp object to remove a soil from any interior surface.
- A stiff brush. It can cause damage to your vehicle's interior surfaces.
- Heavy pressure or aggressive rubbing with a cleaning cloth. Use of heavy pressure can damage your interior and does not improve the effectiveness of soil removal.

- Laundry detergents or dishwashing soaps with degreasers can leave residue that streaks and attracts dirt. For liquid cleaners, about 20 drops per gallon (3.78 L) of water is a good guide. Use only mild, neutral-pH soaps.
- Too much cleaner that saturates the upholstery.
- Organic solvents such as naphtha, alcohol, etc. that can damage your vehicle's interior.

## Fabric/Carpet

Use a vacuum cleaner with a soft brush attachment frequently to remove dust and loose dirt. A canister vacuum with a beater bar in the nozzle may only be used on floor carpet and carpeted floor mats. For any soil, always try to remove it first with plain water or club soda. Before cleaning, gently remove as much of the soil as possible using one of the following techniques:

- For liquids: gently blot the remaining soil with a paper towel. Allow the soil to absorb into the paper towel until no more can be removed.
- For solid dry soils: remove as much as possible and then vacuum.

To clean:

1. Saturate a lint-free, clean white cloth with water or club soda.
2. Wring the cloth to remove excess moisture.

3. Start on the outside edge of the soil and gently rub toward the center. Continue cleaning, using a clean area of the cloth each time it becomes soiled.
4. Continue to gently rub the soiled area until the cleaning cloth remains clean.
5. If the soil is not completely removed, use a mild soap solution and repeat the cleaning process that was used with plain water.

If any of the soil remains, a commercial fabric cleaner or spot lifter may be necessary. When a commercial upholstery cleaner or spot lifter is to be used, test a small hidden area for colorfastness first. If the locally cleaned area gives any impression that a ring formation may result, clean the entire surface.

After the cleaning process has been completed, a paper towel can be used to blot excess moisture from the fabric or carpet.

## Leather

A soft cloth dampened with water can be used to remove dust. If a more thorough cleaning is necessary, a soft cloth dampened with a mild soap solution can be used. Allow the leather to dry naturally. Do not use heat to dry. Never use steam to clean leather. Never use spot lifters or spot removers on leather. Many commercial leather cleaners and coatings that are sold to preserve and protect leather may permanently change the appearance and feel of your leather and are not recommended.

Do not use silicone or wax-based products, or those containing organic solvents to clean your vehicle's interior because they can alter the appearance by increasing the gloss in a non-uniform manner. Never use shoe polish on leather.

## Instrument Panel, Vinyl, and Other Plastic Surfaces

A soft cloth dampened with water may be used to remove dust. If a more thorough cleaning is necessary, a clean soft cloth dampened with a mild soap solution can be used to gently remove dust and dirt. Never use spot lifters or removers on plastic surfaces. Many commercial cleaners and coatings that are sold to preserve and protect soft plastic surfaces may permanently change the appearance and feel of your interior and are not recommended. Do not use silicone or wax-based products, or those containing organic solvents to clean your vehicle's interior because they can alter the appearance by increasing the gloss in a non-uniform manner.

Some commercial products may increase gloss on your instrument panel. The increase in gloss may cause annoying reflections in the windshield and even make it difficult to see through the windshield under certain conditions.

## Wood Panels

Use a clean cloth moistened in warm, soapy water (use mild dish washing soap). Dry the wood immediately with a clean cloth.

## Speaker Covers

Vacuum around a speaker cover gently, so that the speaker will not be damaged. Clean spots with just water and mild soap.

## Care of Safety Belts

Keep belts clean and dry.

### CAUTION:

Do not bleach or dye safety belts. If you do, it may severely weaken them. In a crash, they might not be able to provide adequate protection. Clean safety belts only with mild soap and lukewarm water.

## Weatherstrips

Silicone grease on weatherstrips will make them last longer, seal better, and not stick or squeak. Apply silicone grease with a clean cloth. During very cold, damp weather frequent application may be required. See *Recommended Fluids and Lubricants on page 7-11*.

## Washing Your Vehicle

The best way to preserve your vehicle's finish is to keep it clean by washing it often.

**Notice:** Certain cleaners contain chemicals that can damage the emblems or nameplates on your vehicle. Check the cleaning product label. If it states that it should not be used on plastic parts, do not use it on your vehicle or damage may occur and it would not be covered by the warranty.

Do not wash the vehicle in direct sunlight. Use a car washing soap. Do not use cleaning agents that are petroleum based or that contain acid or abrasives, as they can damage the paint, metal or plastic on your vehicle. Approved cleaning products can be obtained from your dealer/retailer. Follow all manufacturers' directions regarding correct product usage, necessary safety precautions and appropriate disposal of any vehicle care product.

Rinse the vehicle well, before washing and after to remove all cleaning agents completely. If they are allowed to dry on the surface, they could stain.

Dry the finish with a soft, clean chamois or an all-cotton towel to avoid surface scratches and water spotting.

**Notice:** If you drive the vehicle through an automatic car wash that does not have enough clearance for the wide rear tires and wheels, you could damage the vehicle. Verify with the manager of the car wash that the vehicle will fit before entering the car wash or use a touchless car wash.

High pressure car washes may cause water to enter the vehicle. Avoid using high pressure washes closer than 12 inches (30 cm) to the surface of the vehicle. Use of power washers exceeding 1,200 psi (8 274 kPa) can result in damage or removal of paint and decals.

## Cleaning Exterior Lamps/Lenses

Use only lukewarm or cold water, a soft cloth and a car washing soap to clean exterior lamps and lenses. Follow instructions under *Washing Your Vehicle on page 6-77*.

## Finish Care

Occasional waxing or mild polishing of your vehicle by hand may be necessary to remove residue from the paint finish. You can get approved cleaning products from your dealer/retailer.

If your vehicle has a basecoat/clearcoat paint finish, the clearcoat gives more depth and gloss to the colored basecoat. Always use waxes and polishes that are non-abrasive and made for a basecoat/clearcoat paint finish.

**Notice:** Machine compounding or aggressive polishing on a basecoat/clearcoat paint finish may damage it. Use only non-abrasive waxes and polishes that are made for a basecoat/clearcoat paint finish on your vehicle.

Foreign materials such as calcium chloride and other salts, ice melting agents, road oil and tar, tree sap, bird droppings, chemicals from industrial chimneys, etc., can damage your vehicle's finish if they remain on painted surfaces. Wash the vehicle as soon as possible. If necessary, use non-abrasive cleaners that are marked safe for painted surfaces to remove foreign matter.

Exterior painted surfaces are subject to aging, weather and chemical fallout that can take their toll over a period of years. You can help to keep the paint finish looking new by keeping your vehicle garaged or covered whenever possible.

## Protecting Exterior Bright Metal Parts

Bright metal parts should be cleaned regularly to keep their luster. Washing with water is all that is usually needed. However, you may use chrome polish on chrome or stainless steel trim, if necessary.

Use special care with aluminum trim. To avoid damaging protective trim, never use auto or chrome polish, steam or caustic soap to clean aluminum. A coating of wax, rubbed to high polish, is recommended for all bright metal parts.

## Windshield and Wiper Blades

Clean the outside of the windshield with glass cleaner.

Clean the rubber blades using a lint free cloth or paper towel soaked with windshield washer fluid or a mild detergent. Wash the windshield thoroughly when cleaning the blades. Bugs, road grime, sap, and a buildup of vehicle wash/wax treatments may cause wiper streaking. Replace the wiper blades if they are worn or damaged.

Wipers can be damaged by:

- Extreme dusty conditions
- Sand and salt
- Heat and sun
- Snow and ice, without proper removal

## Aluminum or Chrome-Plated Wheels and Trim

Your vehicle may have either aluminum or chrome-plated wheels.

Keep the wheels clean using a soft clean cloth with mild soap and water. Rinse with clean water. After rinsing thoroughly, dry with a soft clean towel. A wax may then be applied.

**Notice:** Chrome wheels and other chrome trim may be damaged if you do not wash your vehicle after driving on roads that have been sprayed with magnesium, calcium or sodium chloride. These chlorides are used on roads for conditions such as ice and dust. Always wash your vehicle's chrome with soap and water after exposure.

**Notice:** If you use strong soaps, chemicals, abrasive polishes, cleaners, brushes, or cleaners that contain acid on aluminum or chrome-plated wheels, you could damage the surface of the wheel(s). The repairs would not be covered by your warranty. Use only approved cleaners on aluminum or chrome-plated wheels.

The surface of these wheels is similar to the painted surface of your vehicle. Do not use strong soaps, chemicals, abrasive polishes, abrasive cleaners, cleaners with acid, or abrasive cleaning brushes on them because you could damage the surface. Do not use chrome polish on aluminum wheels.

**Notice:** Using chrome polish on aluminum wheels could damage the wheels. The repairs would not be covered by your warranty. Use chrome polish on chrome wheels only.

Use chrome polish only on chrome-plated wheels, but avoid any painted surface of the wheel, and buff off immediately after application.

**Notice:** If you drive your vehicle through an automatic car wash that has silicone carbide tire cleaning brushes, you could damage the aluminum or chrome-plated wheels. The repairs would not be covered by your warranty. Never drive a vehicle equipped with aluminum or chrome-plated wheels through an automatic car wash that uses silicone carbide tire cleaning brushes.

## Tires

To clean the tires, use a stiff brush with tire cleaner.

**Notice:** Using petroleum-based tire dressing products on your vehicle may damage the paint finish and/or tires. When applying a tire dressing, always wipe off any overspray from all painted surfaces on your vehicle.

## Sheet Metal Damage

If the vehicle is damaged and requires sheet metal repair or replacement, make sure the body repair shop applies anti-corrosion material to parts repaired or replaced to restore corrosion protection.

Original manufacturer replacement parts will provide the corrosion protection while maintaining the vehicle warranty.

## Finish Damage

Any stone chips, fractures or deep scratches in the finish should be repaired right away. Bare metal will corrode quickly and may develop into major repair expense.

Minor chips and scratches can be repaired with touch-up materials available from your dealer/retailer. Larger areas of finish damage can be corrected in your dealer's/retailer's body and paint shop.

## Underbody Maintenance

Chemicals used for ice and snow removal and dust control can collect on the underbody. If these are not removed, corrosion and rust can develop on the underbody parts such as fuel lines, frame, floor pan, and exhaust system even though they have corrosion protection.

At least every spring, flush these materials from the underbody with plain water. Clean any areas where mud and debris can collect. Dirt packed in close areas of the frame should be loosened before being flushed. Your dealer/retailer or an underbody car washing system can do this for you.



## Fiberglass Springs (Composite Springs)

**Notice:** If you use acidic or corrosive cleaning products, engine degreasers or aluminum cleaning agents on fiberglass springs, you may damage the springs. The repairs would not be covered by your warranty. Use only approved cleaners when cleaning your vehicle's fiberglass springs.

## Chemical Paint Spotting

Some weather and atmospheric conditions can create a chemical fallout. Airborne pollutants can fall upon and attack painted surfaces on the vehicle. This damage can take two forms: blotchy, ring-shaped discolorations, and small, irregular dark spots etched into the paint surface.

Although no defect in the paint job causes this, we will repair, at no charge to the owner, the surfaces of new vehicles damaged by this fallout condition within 12 months or 12,000 miles (20 000 km) of purchase, whichever occurs first.

## Vehicle Identification

### Vehicle Identification Number (VIN)



This is the legal identifier for your vehicle. It appears on a plate in the front corner of the instrument panel, on the driver side. It can be seen through the windshield from outside the vehicle. The VIN also appears on the Vehicle Certification and Service Parts labels and the certificates of title and registration.

## Engine Identification

The eighth character in the VIN is the engine code. This code helps identify the vehicle's engine, specifications, and replacement parts. See "Engine Specifications" under *Capacities and Specifications on page 6-90* for your vehicle's engine code.

## Service Parts Identification Label

This label is on the rear compartment cover in the trunk. It is very helpful if you ever need to order parts. The label has the following information:

- Vehicle Identification Number (VIN)
- Model designation
- Paint information
- Production options and special equipment

Do not remove this label from the vehicle.

## Electrical System

### Add-On Electrical Equipment

**Notice:** Do not add anything electrical to the vehicle unless you check with your dealer/retailer first. Some electrical equipment can damage the vehicle and the damage would not be covered by the vehicle's warranty. Some add-on electrical equipment can keep other components from working as they should.

Add-on equipment can drain the vehicle battery, even if the vehicle is not operating.

The vehicle has an airbag system. Before attempting to add anything electrical to the vehicle, see *Servicing Your Airbag-Equipped Vehicle on page 1-50*.

## Windshield Wiper Fuses

The windshield wiper motor is protected by a circuit breaker and a fuse. If the motor overheats due to heavy snow or ice, the wiper will stop until the motor cools. If the overload is caused by some electrical problem, and not snow or ice, be sure to get it fixed.

## Power Windows and Other Power Options

Circuit breakers in the fuse block protect the power windows and other power accessories. When the current load is too heavy, the circuit breaker opens and closes, protecting the circuit until the problem is fixed or goes away.

## Fuses and Circuit Breakers

The wiring circuits in the vehicle are protected from short circuits by a combination of fuses, circuit breakers and fusible thermal links. This greatly reduces the chance of fires caused by electrical problems.

Look at the silver-colored band inside the fuse. If the band is broken or melted, replace the fuse. Be sure you replace a bad fuse with a new one of the identical size and rating.

Fuses of the same amperage can be temporarily borrowed from another fuse location, if a fuse goes out. Replace the fuse as soon as you can.

## Instrument Panel Fuse Block

The panel fuse block is located on the passenger side of the vehicle, under the instrument panel and under the toe-board.

Remove the carpet and toe-board covering to access the fuse block by pulling at the top of each corner of the panel. Then turn the fuse block door knob counterclockwise and pull the door to access the fuses.



<b>Fuses</b>	<b>Usage</b>
CLSTR/HUD	Instrument Panel Cluster, Heads-up Display (HUD)
COLUMN LK MDL	Not Used
DECK LID CLOSE/PRK/BRK B	Trunk Close Button, Parking Brake Solenoid B
DR LOCKS	Door Locks
ECM	Engine Control Module
EMPTY	Not Used
EMPTY	Not Used
EMPTY	Not Used
EMPTY	Not Used
EMPTY	Not Used
FOLDING TOP/TRUNK LATCH	Retractable Hardtop, Trunk Latch
FUSE PULLER	Fuse Puller
GMLAN DEVICES	GMLAN Devices
HTD STR WHL	Heated Steering Wheel
HTD/SEAT LH	Driver Side Heated Seat
HTD/SEAT RH	Passenger Side Heated Seat
HVAC/PWR SND	Climate Control System, Power Sounder

<b>Fuses</b>	<b>Usage</b>
IGN SW/INTR SNSR	Ignition Switch, Intrusion Sensor
INTERIOR LIGHTS	Interior Lights
ISRVN/HVAC	Inside Rearview Mirror, Climate Control System, Column Lock, Power Sounder
ONSTAR	OnStar <sup>®</sup>
PRK/BRK SOL A	Parking Brake Solenoid A
PWR FLDG MIR-EXT/RET	Power Folding Mirror
PWR LUMBAR LH/RH	Power Lumbar
RADIO/S-BAND/VICS	Radio, S-Band, CD Changer
REAR FOG/ALDL	Rear Fog Lamps, Diagnostic Link Connector
REVERSE LAMP	Reverse Lamp
REVERSE LAMPS	Reverse Lamps
RPA/H/C SEAT/WPR RELAYS	Rear Park Aid, Heated/Cooled Seats, Windshield Wiper Relays
RUN/ACSRY PWR	Run, Accessory Power

<b>Fuses</b>	<b>Usage</b>
RUN/CRANK	Starter/Crank
SDM/PSIR SW	Airbags
SPARE FUSE HOLDER	Spare Fuse
SPARE FUSE HOLDER	Spare Fuse
SPARE FUSE HOLDER	Spare Fuse
SPARE FUSE HOLDER	Spare Fuse
STOP LAMP	Stoplamp
STR WHL DIMMING	Steering Wheel Control Button Lights
TILT/TELE SW/MEM SEAT MOD/TOP SW	Power Tilt Wheel, Telescopic Steering Column, Memory Seat, Driver Seat Switch, Retractable Hardtop Switch
TUTD SW/STRG COL SW	Tap-Up/Tap-Down Switch
WPR DWELL	Rainsense™

<b>Relays</b>	<b>Usage</b>
PRK/BRK HOLD	Park Brake Hold
PRK/BRK RELEASE	Park Brake Release
F/MIR RETRACT	Not Used
FOG RR	Not Used
F/MIR EXTEND	Not Used
FUEL DR	Fuel Door

<b>Circuit Breakers</b>	<b>Usage</b>
PWR SEAT	Power Seats
DR CNTRLS	Door Controls

## Underhood Fuse Block

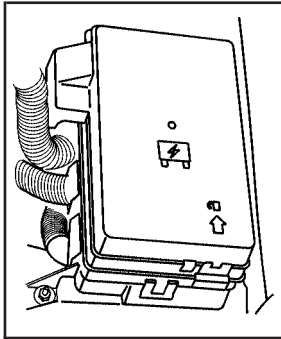

The underhood fuse block is located next to the engine on the passenger side of the vehicle.

For more information on location, see *Engine Compartment Overview* on page 6-12.

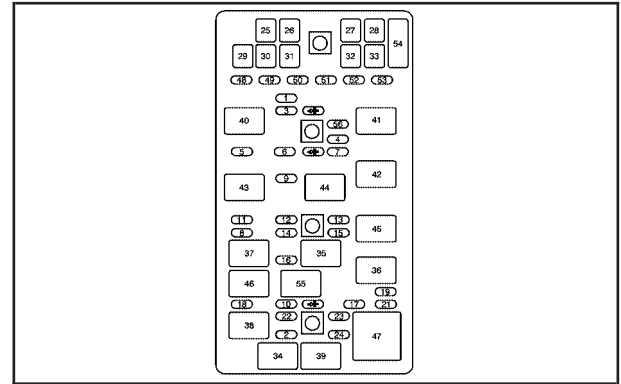

**Notice:** Spilling liquid on any electrical components on the vehicle may damage it. Always keep the covers on any electrical component.

To access the fuses, push in the tab located at the end of the fuse block cover. Then lift the cover open.

Fuses	Usage
1	Antilock Brake System, Electronic Suspension Control, Adaptive Forward Lighting System (AFS)
2	Horn
3	Adaptive Cruise Control (ACC), Transmission Controls

Fuses	Usage
4	Windshield Wipers
5	Stop/Back-Up Lamps
6	Oxygen Sensor
7	Battery 5
8	Parking Lamps
9	Electronic Throttle Control
10	Fuel Pump
11	Antilock Brake System
12	Odd Injectors
13	Electronic Suspension Control
14	Emission Controls
15	Air Conditioning Compressor
16	Even Injectors
17	Windshield Washer, Adaptive Forward Lighting System (AFS), Intercooler Pump
18	Headlamp Washer



Fuses	Usage
19	Right Low Beam Headlamp
20	Not Used
21	Left Low Beam Headlamp
22	Fog Lamp
23	Right High Beam Headlamp
24	Left High Beam Headlamp
25	Cooling Fan
26	Battery 3
27	Antilock Brakes
28	Climate Controls
29	Battery 2
30	Starter
31	Audio Amplifier
32	Not Used
33	Battery 1
48	Spare



<b>Fuses</b>	<b>Usage</b>
49	Spare
50	Spare
51	Spare
52	Spare
53	Not Used
54	Fuse Puller
56	Engine Control Module, Transmission Control Module

<b>Relays</b>	<b>Usage</b>
34	Horn
35	Air Conditioning Compressor
36	Windshield Washer
37	Parking Lamps
38	Fog Lamps
39	High Beam Headlamps

<b>Relays</b>	<b>Usage</b>
40	Rear Window Defogger
41	Windshield Wiper High/Low
42	Wiper RUN/ACCESSORY Power
43	Starter/Crank
44	Ignition 1
45	Windshield Wiper On/Off
46	Headlamp Washer
47	Low Beam Headlamps
55	Fuel Pump

<b>Diodes</b>	<b>Usage</b>
	Diode 1
	Wiper Diode
	Diode 2

## Capacities and Specifications

The following approximate capacities are given in English and metric conversions. Please refer to *Recommended Fluids and Lubricants on page 7-11* for more information.

Application	Capacities	
	English	Metric
Air Conditioning Refrigerant R134a	For the air conditioning system refrigerant charge amount, see the refrigerant caution label located under the hood. See your dealer/retailer for more information.	
Cooling System	12.6 qt	12.0 L
Cooling System — Intercooler	2.4 qt	2.3 L
Engine Oil with Filter – 4.4L V8 and 4.6L V8 Engines	8.0 qt	7.6 L
Fuel Tank	18.0 gal	68.0 L
Transmission Fluid (Pan Removal and Replacement)		
6-Speed Automatic	6.5 qt	6.2 L
Wheel Nut Torque	100 ft lb	140 N•m
All capacities are approximate. When adding, be sure to fill to the approximate level as recommended in this manual. Recheck fluid level after filling.		

## Engine Specifications

Engine	VIN Code	Transmission	Spark Plug Gap
4.4L V8	D	Automatic	0.040 in (1.02 mm)
4.6L V8	A	Automatic	0.050 in (1.27 mm)

## XLR-V Engine Data

Engine	Horsepower	Torque	Displacement	Compression Ratio
4.4L V8 (V-Series)	443 hp (330 kW) @ 6400 rpm	414 lb ft (561 Nm) @ 3900 rpm	4.4L	9.0:1



# Section 7 Maintenance Schedule

---

<b>Maintenance Schedule</b> .....	7-2	Owner Checks and Services .....	7-9
Introduction .....	7-2	At Each Fuel Fill .....	7-9
Maintenance Requirements .....	7-2	At Least Once a Month .....	7-9
Your Vehicle and the Environment .....	7-2	At Least Once a Year .....	7-10
Using the Maintenance Schedule .....	7-3	Recommended Fluids and Lubricants .....	7-11
Scheduled Maintenance .....	7-4	Maintenance Replacement Parts .....	7-13
Additional Required Services .....	7-6	Engine Drive Belt Routing .....	7-14
Maintenance Footnotes .....	7-7	Maintenance Record .....	7-15

# Maintenance Schedule

## Introduction

**Important:** Keep engine oil at the proper level and change as recommended.



*Have you purchased the GM Protection Plan? The Plan supplements the vehicle warranties. See the Warranty and Owner Assistance booklet or your dealer/retailer for details.*

# Maintenance Requirements

**Notice:** Maintenance intervals, checks, inspections, replacement parts, and recommended fluids and lubricants as prescribed in this manual are necessary to keep this vehicle in good working condition. Any damage caused by failure to follow scheduled maintenance might not be covered by the vehicle warranty.

## Your Vehicle and the Environment

Proper vehicle maintenance not only helps to keep the vehicle in good working condition, but also helps the environment. All recommended maintenance is important. Improper vehicle maintenance can even affect the quality of the air we breathe. Improper fluid levels or the wrong tire inflation can increase the level of emissions from the vehicle. To help protect the environment, and to keep the vehicle in good condition, be sure to maintain the vehicle properly.

## Using the Maintenance Schedule

We want to help keep this vehicle in good working condition. But we do not know exactly how you will drive it. You might drive very short distances only a few times a week. Or you might drive long distances all the time in very hot, dusty weather. You might use the vehicle in making deliveries. Or you might drive it to work, to do errands, or in many other ways.

Because of all the different ways people use their vehicles, maintenance needs vary. You might need more frequent checks and replacements. So please read the following and note how you drive. If you have any questions on how to keep the vehicle in good condition, see your dealer/retailer.

This schedule is for vehicles that:

- carry passengers and cargo within recommended limits on the Tire and Loading Information label. See *Loading the Vehicle on page 5-21*.
- are driven on reasonable road surfaces within legal driving limits.
- use the recommended fuel. See *Gasoline Octane on page 6-5*.

The services in *Scheduled Maintenance on page 7-4* should be performed when indicated. See *Additional Required Services on page 7-6* and *Maintenance Footnotes on page 7-7* for further information.

### CAUTION:

Performing maintenance work on a vehicle can be dangerous. In trying to do some jobs, you can be seriously injured. Do your own maintenance work only if you have the required know-how and the proper tools and equipment for the job. If you have any doubt, see your dealer/retailer to have a qualified technician do the work. See *Doing Your Own Service Work on page 6-4*.

Some maintenance services can be complex. So, unless you are technically qualified and have the necessary equipment, have your dealer/retailer do these jobs.

When you go to your dealer/retailer for service, trained and supported service technicians will perform the work using genuine parts.

To purchase service information, see *Service Publications Ordering Information on page 8-15*.

*Owner Checks and Services on page 7-9* tells what should be checked, when to check it, and what can easily be done to help keep the vehicle in good condition.

The proper replacement parts, fluids, and lubricants to use are listed in *Recommended Fluids and Lubricants on page 7-11* and *Maintenance Replacement Parts on page 7-13*. When the vehicle is serviced, make sure these are used. All parts should be replaced and all necessary repairs done before you or anyone else drives the vehicle. We recommend the use of genuine parts from your dealer/retailer.

## Scheduled Maintenance

To maintain the ride, handling, and performance of this vehicle, it is important that the first tire rotation service be performed when you notice unusual wear. Check tires for inflation pressures and wear. See *Tires on page 6-46*. If tire rotation is recommended for the vehicle, rotate tires. See *Tire Inspection and Rotation on page 6-60*.

When the CHANGE OIL NOW message displays in the Driver Information Center (DIC), service is required for the vehicle. Have the vehicle serviced as soon as possible within the next 600 miles (1 000 km). It is possible that, if driving under the best conditions, the engine oil life system may not indicate that vehicle service is necessary for over a year. However, the engine oil and filter must be changed at least once a year and at this time the system must be reset. Your dealer/retailer has trained service technicians who will perform this work using genuine parts and reset the system.

If the engine oil life system is ever reset accidentally, service the vehicle within 3,000 miles (5 000 km) since the last service. Remember to reset the oil life system whenever the oil is changed. See *Engine Oil Life System on page 6-18* for information on the Engine Oil Life System and resetting the system.



When the CHANGE OIL NOW message appears, the following services, checks, and inspections are required:

- Change engine oil and filter. See *Engine Oil* on page 6-15. Reset oil life system. See *Engine Oil Life System* on page 6-18. *An Emission Control Service*.
- Visually check for any leaks or damage. See footnote (a).
- Inspect engine air cleaner filter. If necessary, replace filter. See *Engine Air Cleaner/Filter* on page 6-20. See footnote (h).
- Check tires for inflation pressures and wear. See *Tires* on page 6-46. If tire rotation is recommended for the vehicle, rotate tires. See *Tire Inspection and Rotation* on page 6-60.
- Inspect brake system. See footnote (l).
- Check engine coolant and windshield washer fluid levels. If the vehicle has the 4.4L V8 supercharged engine, check intercooler fluid level. Add fluid as needed.
- Perform any needed additional services. See “Additional Required Services” in this section.
- Inspect suspension and steering components. See footnote (n).
- Inspect engine cooling system. See footnote (m).
- Inspect wiper blades. See footnote (b).
- Inspect restraint system components. See footnote (c).
- Lubricate body components. See footnote (d).

## Additional Required Services

The following services should be performed at the first maintenance service after the indicated miles (kilometers) shown for each item.

### Additional Required Services

Service and Miles (Kilometers)	25,000 (40 000)	50,000 (80 000)	75,000 (120 000)	100,000 (160 000)	125,000 (200 000)	150,000 (240 000)
Inspect fuel system for damage or leaks.		•		•		•
Inspect exhaust system for loose or damaged components.				•		
Replace engine air cleaner filter. See <i>Engine Air Cleaner/Filter</i> on page 6-20.		•		•		•
Replace passenger compartment air filter. See <i>footnote (e)</i> .	•	•	•	•	•	•
Change automatic transmission fluid and filter (severe service). See <i>footnote (f)</i> .		•		•		•
Change automatic transmission fluid and filter (normal service).				•		
Replace spark plugs. <i>An Emission Control Service</i> .				•		

## Additional Required Services (cont'd)

Service and Miles (Kilometers)	25,000 (40 000)	50,000 (80 000)	75,000 (120 000)	100,000 (160 000)	125,000 (200 000)	150,000 (240 000)
Engine cooling system service (or every five years, whichever occurs first). <i>An Emission Control Service.</i> <i>See footnote (g).</i>						•
4.4L Supercharged Engine: Intercooler system service (or every five years, whichever occurs first). <i>See footnote (k).</i>						•
Inspect engine accessory drive belt. <i>An Emission Control Service.</i> <i>See footnote (j).</i>						•

## Maintenance Footnotes

(a) *A fluid loss in any vehicle system could indicate a problem. Have the system inspected and repaired and the fluid level checked. Add fluid if needed.*

(b) *Inspect wiper blades for wear, cracking, or contamination. Clean the windshield and wiper blades, if contaminated. Replace wiper blades that are worn or damaged. See Windshield Wiper Blade Replacement on page 6-45 and Windshield and Wiper Blades on page 6-78 for more information.*

(c) *Make sure the safety belt reminder light and safety belt assemblies are working properly. Look for any other loose or damaged safety belt system parts. If you see anything that might keep a safety belt system from doing its job, have it repaired. Have any torn or frayed safety belts replaced. Also see Checking the Restraint Systems on page 1-52.*

(d) *Lubricate the trunk key lock cylinder. Lubricate all body door hinges. Lubricate all hinges and latches, including those for the hood, trunk, console door, and any folding seat hardware. More frequent lubrication may be required when exposed to a corrosive environment. Applying silicone grease on weatherstrips with a clean cloth will make them last longer, seal better, and not stick or squeak.*

(e) *If driving regularly under dusty conditions, the filter may require replacement more often.*

(f) *Change automatic transmission fluid and filter if the vehicle is mainly driven under one or more of these conditions:*

- In heavy city traffic where the outside temperature regularly reaches 90°F (32°C) or higher.*
- In hilly or mountainous terrain.*
- Uses such as high performance operation.*

(g) *Drain, flush, and refill cooling system. This service can be complex; you should have your dealer/retailer perform this service. See Engine Coolant on page 6-23 for what to use. Inspect hoses. Clean radiator, condenser, pressure cap, and filler neck. Pressure test the cooling system and pressure cap.*

(h) *If driving regularly under dusty conditions, inspect the filter at each engine oil change.*

(j) *Visually inspect belt for fraying, excessive cracks, or obvious damage. Replace belt if necessary.*

(k) *Drain, flush, and refill intercooler system. This service can be complex; you should have your dealer/retailer perform this service. See Engine Coolant on page 6-23 for what to use. Inspect hoses. Clean pressure cap and filler neck. Pressure test the system and pressure cap.*

(l) *Visually inspect brake lines and hoses for proper hook-up, binding, leaks, cracks, chafing, etc. Inspect disc brake pads for wear and rotors for surface condition. Inspect other brake parts, including calipers, parking brake, etc.*

(m) *Visually inspect hoses and have them replaced if they are cracked, swollen, or deteriorated. Inspect all pipes, fittings, and clamps; replace with genuine parts as needed. To help ensure proper operation, a pressure test of the cooling system and pressure cap and cleaning the outside of the radiator and air conditioning condenser is recommended at least once a year.*

(n) *Visually inspect front and rear suspension and steering system for damaged, loose, or missing parts or signs of wear. Inspect power steering lines and hoses for proper hook-up, binding, leaks, cracks, chafing, etc. XLR-V Only: Lubricate the outer ends of both rear toe-links every other oil change.*

## Owner Checks and Services

These owner checks and services should be performed at the intervals specified to help ensure vehicle safety, dependability, and emission control performance. Your dealer/retailer can assist with these checks and services.

Be sure any necessary repairs are completed at once. Whenever any fluids or lubricants are added to the vehicle, make sure they are the proper ones, as shown in *Recommended Fluids and Lubricants on page 7-11*.

### At Each Fuel Fill

*It is important to perform these underhood checks at each fuel fill.*

### Engine Oil Level Check

**Notice:** It is important to check the engine oil regularly and keep it at the proper level. Failure to keep the engine oil at the proper level can cause damage to the engine not covered by the vehicle warranty.

Check the engine oil level and add the proper oil if necessary. See *Engine Oil on page 6-15*.

### Engine Coolant Level Check

Check the engine coolant level and add DEX-COOL<sup>®</sup> coolant mixture if necessary. See *Engine Coolant on page 6-23*.

### Intercooler Coolant Level Check (4.4L Supercharged Engine)

Check the coolant level and add DEX-COOL<sup>®</sup> coolant mixture if necessary. See *Engine Coolant on page 6-23*.

### Windshield Washer Fluid Level Check

Check the windshield washer fluid level in the windshield washer fluid reservoir and add the proper fluid if necessary. See *Windshield Washer Fluid on page 6-31*.

### At Least Once a Month

### Tire Inspection and Inflation Check

Inspect the vehicle's tires for wear and make sure they are inflated to the correct pressures. See *Inflation - Tire Pressure on page 6-54*.

## At Least Once a Year

### Starter Switch Check

#### CAUTION:

When you are doing this inspection, the vehicle could move suddenly. If the vehicle moves, you or others could be injured.

1. Before starting this check, be sure there is enough room around the vehicle.
2. Firmly apply both the parking brake and the regular brake. See *Parking Brake on page 2-32*.  
Do not use the accelerator pedal, and be ready to turn off the engine immediately if it starts.
3. Try to start the engine in each gear. The vehicle should start only in P (Park) or N (Neutral). If the vehicle starts in any other position, contact your dealer/retailer for service.

### Automatic Transmission Shift Lock Control System Check

#### CAUTION:

When you are doing this inspection, the vehicle could move suddenly. If the vehicle moves, you or others could be injured.

1. Before starting this check, be sure there is enough room around the vehicle. It should be parked on a level surface.
2. Firmly apply the parking brake. See *Parking Brake on page 2-32*.  
Be ready to apply the regular brake immediately if the vehicle begins to move.
3. With the engine off and without applying the regular brake, try to move the shift lever out of P (Park) with normal effort. If the shift lever moves out of P (Park), contact your dealer/retailer for service.

## Parking Brake and Automatic Transmission P (Park) Mechanism Check

### CAUTION:

When you are doing this check, the vehicle could begin to move. You or others could be injured and property could be damaged. Make sure there is room in front of the vehicle in case it begins to roll. Be ready to apply the regular brake at once should the vehicle begin to move.

Park on a fairly steep hill, with the vehicle facing downhill. Keeping your foot on the regular brake, set the parking brake.

- To check the parking brake's holding ability: With the engine running and transmission in N (Neutral), slowly remove foot pressure from the regular brake pedal. Do this until the vehicle is held by the parking brake only.
- To check the P (Park) mechanism's holding ability: With the engine running, shift to P (Park). Then release the parking brake followed by the regular brake.

Contact your dealer/retailer if service is required.

## Underbody Flushing Service

At least every spring, use plain water to flush any corrosive materials from the underbody. Take care to clean thoroughly any areas where mud and other debris can collect.

## Recommended Fluids and Lubricants

Fluids and lubricants identified below by name, part number, or specification can be obtained from your dealer/retailer.

Usage	Fluid/Lubricant
Engine Oil	The engine requires a special engine oil meeting GM Standard GM4718M. Oils meeting this standard can be identified as synthetic, and should also be identified with the American Petroleum Institute (API) Certified for Gasoline Engines starburst symbol. However, not all synthetic API oils with the starburst symbol will meet this GM standard. Look for and use only an oil that meets GM Standard GM4718M. For the proper viscosity, see <i>Engine Oil</i> on page 6-15.

Usage	Fluid/Lubricant
Engine Cooling System	50/50 mixture of clean, drinkable water and use only DEX-COOL® Coolant. See <i>Engine Coolant</i> on page 6-23.
Intercooler System (4.4L V8 Supercharged engine)	50/50 mixture of clean, drinkable water and use only DEX-COOL® Coolant.
Hydraulic Brake System	Delco® Supreme 11 Brake Fluid or equivalent DOT-3 brake fluid.
Windshield Washer	Optikleen® Washer Solvent.
Power Steering System	GM Power Steering Fluid (GM Part No. U.S. 89021184, in Canada 89021186).
XLR-V: Chassis Lubrication (Rear Toe-Link Outer Ends)	Chassis Lubricant (GM Part No. U.S. 12377985, in Canada 88901242) or lubricant meeting requirements of NLGI #2, Category LB or GC-LB.
Automatic Transmission	DEXRON®-VI Automatic Transmission Fluid.

Usage	Fluid/Lubricant
Trunk Key Lock Cylinder	Multi-Purpose Lubricant, Superlube (GM Part No. U.S. 12346241, in Canada 10953474).
Rear Axle (Limited-Slip Differential)	DEXRON® LS Gear Oil (GM Part No. U.S. 88862624, in Canada 88862625) meeting GM Specification 9986290. See <i>Rear Axle</i> on page 6-41.
Hood Latch Assembly, Secondary Latch, Pivots, Spring Anchor, and Release Pawl	Lubriplate Lubricant Aerosol (GM Part No. U.S. 12346293, in Canada 992723) or lubricant meeting requirements of NLGI #2, Category LB or GC-LB.
Hood and Door Hinges	Multi-Purpose Lubricant, Superlube (GM Part No. U.S. 12346241, in Canada 10953474).
Weatherstrip Conditioning	Weatherstrip Lubricant (GM Part No. U.S. 3634770, in Canada 10953518) or Dielectric Silicone Grease (GM Part No. U.S. 12345579, in Canada 992887).



## Maintenance Replacement Parts

Replacement parts identified below by name, part number, or specification can be obtained from your dealer/retailer.

<b>Part</b>	<b>GM Part Number</b>	<b>ACDelco Part Number</b>
Engine Air Cleaner/Filter Elements		
4.4 L V8 Engine	10342024	A2945C
4.6 L V8 Engine	19166106	A1208C
Engine Oil Filter		
4.4 L V8 Engine	89017527	PF26
4.6 L V8 Engine	89017342	PF61
Passenger Compartment Air Filter Element	25917369	CF139
Spark Plugs		
4.4 L V8 Engine	12592619	41-991
4.6 L V8 Engine	12571535	41-987
Wiper Blades		
Driver Side	88987071	—
Passenger Side	88987072	—

# Engine Drive Belt Routing

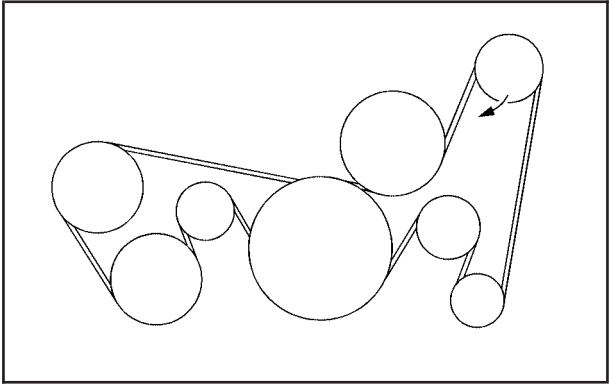

4.6L V8 Engine

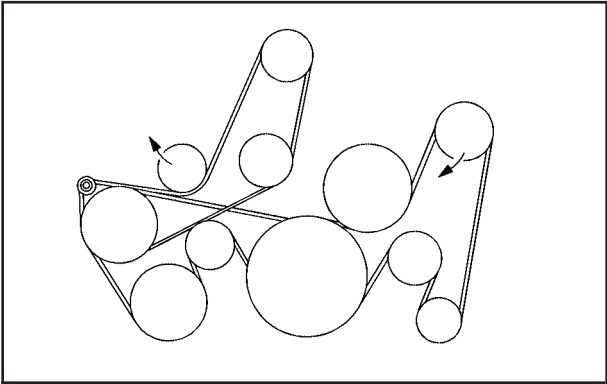

4.4L V8 Engine

## Maintenance Record

After the scheduled services are performed, record the date, odometer reading, who performed the service, and the type of services performed in the boxes provided. See *Maintenance Requirements on page 7-2*. Any additional information from *Owner Checks and Services on page 7-9* can be added on the following record pages. You should retain all maintenance receipts.

### Maintenance Record

Date	Odometer Reading	Serviced By	Maintenance Stamp	Services Performed



### Maintenance Record (cont'd)

Date	Odometer Reading	Serviced By	Maintenance Stamp	Services Performed

### Maintenance Record (cont'd)

Date	Odometer Reading	Serviced By	Maintenance Stamp	Services Performed

## Section 8 Customer Assistance Information

---

<b>Customer Assistance and Information</b> .....	8-2	<b>Reporting Safety Defects</b> .....	8-14
Customer Satisfaction Procedure .....	8-2	Reporting Safety Defects to the United States Government .....	8-14
Online Owner Center .....	8-5	Reporting Safety Defects to the Canadian Government .....	8-15
Customer Assistance for Text Telephone (TTY) Users .....	8-6	Reporting Safety Defects to General Motors .....	8-15
Customer Assistance Offices .....	8-6	Service Publications Ordering Information .....	8-15
GM Mobility Reimbursement Program .....	8-7	<b>Vehicle Data Recording and Privacy</b> .....	8-16
Roadside Service .....	8-7	Event Data Recorders .....	8-17
Scheduling Service Appointments .....	8-10	OnStar® .....	8-18
Courtesy Transportation .....	8-10	Navigation System .....	8-18
Collision Damage Repair .....	8-11	Radio Frequency Identification (RFID) .....	8-18

# Customer Assistance and Information

## Customer Satisfaction Procedure

Your satisfaction and goodwill are important to your dealer and to Cadillac. Normally, any concerns with the sales transaction or the operation of the vehicle will be resolved by the dealer's sales or service departments. Sometimes, however, despite the best intentions of all concerned, misunderstandings can occur. If your concern has not been resolved to your satisfaction, the following steps should be taken:

**STEP ONE:** Discuss your concern with a member of dealership management. Normally, concerns can be quickly resolved at that level. If the matter has already been reviewed with the sales, service or parts manager, contact the owner of the dealership or the general manager.

**STEP TWO:** If after contacting a member of dealership management, it appears your concern cannot be resolved by the dealership without further help, in the United States, call the Cadillac Customer Assistance Center, 24 hours a day, at 1-800-458-8006. In Canada, call the Canadian Cadillac Customer Communication Centre at 1-888-446-2000.

We encourage you to call the toll-free number in order to give your inquiry prompt attention. Have the following information available to give the Customer Assistance Representative:

- Vehicle Identification Number (VIN). This is available from the vehicle registration or title, or the plate at the top left of the instrument panel and visible through the windshield.
- Dealership name and location.
- Vehicle delivery date and present mileage.

When contacting Cadillac, remember that your concern will likely be resolved at a dealer's facility. That is why we suggest following Step One first.



**STEP THREE (U.S. Owners):** Both General Motors and your dealer are committed to making sure you are completely satisfied with your new vehicle. However, if you continue to remain unsatisfied after following the procedure outlined in Steps One and Two, you can file with the Better Business Bureau (BBB) Auto Line Program to enforce your rights.

The BBB Auto Line Program is an out of court program administered by the Council of Better Business Bureaus to settle automotive disputes regarding vehicle repairs or the interpretation of the New Vehicle Limited Warranty. Although you may be required to resort to this informal dispute resolution program prior to filing a court action, use of the program is free of charge and your case will generally be heard within 40 days. If you do not agree with the decision given in your case, you may reject it and proceed with any other venue for relief available to you.

You may contact the BBB Auto Line Program using the toll-free telephone number or write them at the following address:

BBB Auto Line Program  
Council of Better Business Bureaus, Inc.  
4200 Wilson Boulevard  
Suite 800  
Arlington, VA 22203-1838  
Telephone: 1-800-955-5100  
[dr.bbb.org/goauto](http://dr.bbb.org/goauto)

This program is available in all 50 states and the District of Columbia. Eligibility is limited by vehicle age, mileage and other factors. General Motors reserves the right to change eligibility limitations and/or discontinue its participation in this program.

### **STEP THREE (Canadian Owners):**

#### **General Motors Participation in the Mediation/Arbitration Program**

In the event that you do not feel your concerns have been addressed after the following the procedure outlined in Steps One and Two. General Motors of Canada Limited wants you to be aware of its participation in a no-charge mediation/Arbitration program. General Motors of Canada Limited has committed to binding arbitration of owner disputes involving factory-related vehicle service claims. The program provides for the review of the facts involved by an impartial third party arbiter, and may include an informal hearing before the arbiter. The program is designed so that the entire dispute settlement process, from the time you file your complaint to the final decision, should be completed in approximately 70 days. We believe our impartial program offers advantages over courts in most jurisdictions because it is informal, quick, and free of charge.

For further information concerning eligibility in the Canadian Motor Vehicle Arbitration Plan (CAMVAP), call toll-free 1-800-207-0685, or call the General Motors Customer Communication Centre, 1-800-263-3777 (English), 1-800-263-7854 (French), or write to the Mediation/Arbitration Program at the following address.

Mediation/Arbitration Program  
c/o Customer Communication Centre  
General Motors of Canada Limited  
Mail Code: CA1-163-005  
1908 Colonel Sam Drive  
Oshawa, Ontario L1H 8P7

Your inquiry should be accompanied by the Vehicle Identification Number (VIN).

## Online Owner Center

### (United States only)

The Owner Center is a resource for your GM ownership needs. Specific vehicle information can be found in one place.

#### The Online Owner Center allows you to:

- Get e-mail service reminders.
- Access information about your specific vehicle, including tips and videos and an electronic version of this owner manual.
- Keep track of your vehicle's service history and maintenance schedule.
- Find GM dealers/retailers for service nationwide.
- Receive special promotions and privileges only available to members.

Refer to [MyGMLink.com](http://MyGMLink.com) on the web for updated information and to register your vehicle.

## My GM Canada (Canada only)

My GM Canada is a password-protected section of [gmcanada.com](http://gmcanada.com) where you can save information on GM vehicles, get personalized offers, and use handy tools and forms with greater ease.

Here are a few of the valuable tools and services you will have access to:

- My Showroom: Find and save information on vehicles and current offers in your area.
- My Dealers/Retailers: Save details such as address and phone number for each of your preferred GM Dealers or Retailers.
- My Driveway: Receive service reminders and helpful advice on owning and maintaining your vehicle.
- My Preferences: Manage your profile, subscribe to E-News and use tools and forms with greater ease.

To sign up to My GM Canada, visit the My GM Canada section within [gmcanada.com](http://gmcanada.com).

## **Customer Assistance for Text Telephone (TTY) Users**

To assist customers who are deaf, hard of hearing, or speech-impaired and who use Text Telephones (TTYs), Cadillac has TTY equipment available at its Customer Assistance Center. Any TTY user can communicate with Cadillac by dialing: 1-800-833-CMCC (2622). (TTY users in Canada can dial 1-800-263-3830.)

## **Customer Assistance Offices**

Cadillac encourages customers to call the toll-free number for assistance. However, if a customer wishes to write or e-mail Cadillac, the letter should be addressed to:

### **United States — Customer Assistance**

Cadillac Customer Assistance Center  
Cadillac Motor Car Division  
P.O. Box 33169  
Detroit, MI 48232-5169

[www.Cadillac.com](http://www.Cadillac.com)  
1-800-458-8006  
1-800-833-2622 (For Text Telephone devices (TTYs))  
Roadside Assistance: 1-800-882-1112

From Puerto Rico:  
1-800-496-9992 (English)  
1-800-496-9993 (Spanish)

From U.S. Virgin Islands:  
1-800-496-9994

### **Canada — Customer Assistance**

General Motors of Canada Limited  
Canadian Cadillac Customer Communication Centre,  
CA1-163-005  
1908 Colonel Sam Drive  
Oshawa, Ontario L1H 8P7

[www.gmcanada.com](http://www.gmcanada.com)  
1-888-446-2000  
1-800-263-3830 (For Text Telephone devices (TTYs))  
Roadside Assistance: 1-800-882-1112

### **Overseas — Customer Assistance**

Please contact the local General Motors Business Unit.

## Mexico, Central America and Caribbean Islands/Countries (Except Puerto Rico and U.S. Virgin Islands) — Customer Assistance

General Motors de Mexico, S. de R.L. de C.V.  
Customer Assistance Center  
Paseo de la Reforma # 2740  
Col. Lomas de Bezares  
C.P. 11910, Mexico, D.F.  
01-800-508-0000  
Long Distance: 011-52-53 29 0 800

## GM Mobility Reimbursement Program



This program, available to qualified applicants, can reimburse you up to \$1,000 of the cost of eligible aftermarket adaptive equipment required for your vehicle, such as hand controls or a wheelchair/scooter lift.

The offer is available for a very limited period of time from the date of vehicle purchase/lease. For more details, or to determine your vehicle's eligibility, visit [gmmobility.com](http://gmmobility.com) or call the GM Mobility Assistance Center at 1-800-323-9935. Text telephone (TTY) users, call 1-800-833-9935.

General Motors of Canada also has a Mobility Program. Call 1-800-GM-DRIVE (463-7483) for details. TTY users call 1-800-263-3830.

## Roadside Service

In the United States or Canada, call **1-800-882-1112**. Text Telephone (TTY), U.S. only, call **1-888-889-2438**. Service is available 24 hours a day, 365 days a year.

## Calling for Assistance

When calling Roadside Assistance, have the following information ready:

- Your name, home address, and home telephone number
- Telephone number of your location
- Location of the vehicle
- Model, year, color, and license plate number of the vehicle
- Odometer reading, Vehicle Identification Number (VIN), and delivery date of the vehicle
- Description of the problem

## Coverage

Services are provided up to 5 years/100,000 miles (160 000 km), whichever comes first.

In the U.S., anyone driving the vehicle is covered. In Canada, a person driving the vehicle without permission from the owner is not covered.

Roadside Assistance is not a part of the New Vehicle Limited Warranty. Cadillac and General Motors of Canada Limited reserve the right to make any changes or discontinue the Roadside Assistance program at any time without notification.

Cadillac and General Motors of Canada Limited reserve the right to limit services or payment to an owner or driver if they decide the claims are made too often, or the same type of claim is made many times.

### Cadillac Owner Privileges™

- **Emergency Fuel Delivery:** Delivery of enough fuel for the vehicle to get to the nearest service station.
- **Lock-Out Service:** Service is provided to unlock the vehicle if you are locked out. A remote unlock may be available if you have OnStar®. For security reasons, the driver must present identification before this service is given.
- **Emergency Tow From a Public Road or Highway:** Tow to the nearest Cadillac dealer for warranty service, or if the vehicle was in a crash and cannot be driven. Assistance is also given when the vehicle is stuck in the sand, mud, or snow.
- **Flat Tire Change:** Service is provided to change a flat tire with spare tire. The spare tire, if equipped, must be in good condition and properly inflated. It is your responsibility for the repair or replacement of the tire if it is not covered by the warranty.
- **Battery Jump Start:** Service is provided to jump start a dead battery.
- **Trip Routing Service:** Detailed maps of North America are provided when requested either with the most direct route or the most scenic route. Additional travel information is also available. Allow three weeks for delivery.
- **Trip Interruption Benefits and Assistance:** If your trip is interrupted due to a warranty failure, incidental expenses may be reimbursed during the 5 year/100,000 miles (160 000 km) Powertrain warranty period. Items considered are hotel, meals, and rental car.

## Cadillac Technician Roadside Service (U.S. only)

Cadillac's exceptional Roadside Service is more than an auto club or towing service. It provides every Cadillac owner in the United States with the advantage of contacting a Cadillac advisor and, where available, a Cadillac trained dealer technician who can provide on-site service.

A dealer technician will travel to your location within a 30 mile radius of a participating Cadillac dealership. If beyond this radius, we will arrange to have your car towed to the nearest Cadillac dealership. Each technician travels with a specially equipped service vehicle complete with the necessary Cadillac parts and tools required to handle most roadside repairs.

## Services Not Included in Roadside Assistance

- Impound towing caused by violation of any laws.
- Legal fines.
- Mounting, dismounting or changing of snow tires, chains, or other traction devices.
- Towing or services for vehicles driven on a non-public road or highway.

## Services Specific to Canadian Purchased Vehicles

- **Fuel delivery:** Reimbursement is approximately \$5 Canadian. Diesel fuel delivery may be restricted. Propane and other fuels are not provided through this service.
- **Lock-Out Service:** Vehicle registration is required.
- **Trip Routing Service:** Limit of six requests per year.
- **Trip Interruption Benefits and Assistance:** Pre-authorization, original detailed receipts, and a copy of the repair orders are required. Once authorization has been received, the Roadside Assistance advisor will help you make arrangements and explain how to receive payment.
- **Alternative Service:** If assistance cannot be provided right away, the Roadside Assistance advisor may give you permission to get local emergency road service. You will receive payment, up to \$100, after sending the original receipt to Roadside Assistance. Mechanical failures may be covered, however any cost for parts and labor for repairs not covered by the warranty are the owner responsibility.

## **Scheduling Service Appointments**

When your vehicle requires warranty service, contact your dealer/retailer and request an appointment.

By scheduling a service appointment and advising your service consultant of your transportation needs, your dealer/retailer can help minimize your inconvenience.

If your vehicle cannot be scheduled into the service department immediately, keep driving it until it can be scheduled for service, unless, of course, the problem is safety-related. If it is, please call your dealership/retailer, let them know this, and ask for instructions.

If the dealer/retailer requests you to bring the vehicle for service, you are urged to do so as early in the work day as possible to allow for the same day repair.

## **Courtesy Transportation**

To enhance your ownership experience, we and our participating dealers are proud to offer Courtesy Transportation, a customer support program for vehicles with the Bumper to Bumper (Base Warranty Coverage period in Canada) and extended powertrain warranty in both the U.S. and Canada.

Several courtesy transportation options are available to assist in reducing your inconvenience when warranty repairs are required.

Courtesy Transportation is not a part of the New Vehicle Limited Warranty. A separate booklet entitled "Warranty and Owner Assistance Information" furnished with each new vehicle provides detailed warranty coverage information.

## **Transportation Options**

Warranty service can generally be completed while you wait. However, if you are unable to wait, GM helps to minimize your inconvenience by providing several transportation options. Depending on the circumstances, your dealer can offer you one of the following:

### **Shuttle Service**

Participating dealers can provide shuttle service to get you to your destination with minimal interruption of your daily schedule. This includes one-way or round trip shuttle service to a destination up to 10 miles (16 km) from the dealership.

### **Public Transportation or Fuel Reimbursement**

If your vehicle requires warranty repairs, and public transportation is used instead of the dealer's shuttle service, the expense must be supported by original receipts and can only be up to the maximum amount allowed by GM for shuttle service.



In addition, for U.S. customers, should you arrange transportation through a friend or relative, limited reimbursement for reasonable fuel expenses may be available. Claim amounts should reflect actual costs and be supported by original receipts. See your dealer for information regarding the allowance amounts for reimbursement of fuel or other transportation costs.

### **Courtesy Rental Vehicle**

Your dealer may arrange to provide you with a courtesy rental vehicle or reimburse you for a rental vehicle that you obtain if your vehicle is kept for a warranty repair. If you obtain a rental vehicle on your own, please see your dealer for the maximum number of days allowed and the allowance per rental day. Rental reimbursement must be supported by original receipts. This requires that you sign and complete a rental agreement and meet state, local, and rental vehicle provider requirements. Requirements vary and may include minimum age requirements, insurance coverage, credit card, etc. You are responsible for fuel usage charges and may also be responsible for taxes, levies, usage fees, excessive mileage, or rental usage beyond the completion of the repair.

It may not be possible to provide a like-vehicle as a courtesy rental.

### **Additional Program Information**

All program options, such as shuttle service, may not be available at every dealer. Please contact your dealer for specific information about availability. All Courtesy Transportation arrangements will be administered by appropriate dealer personnel.

*General Motors reserves the right to unilaterally modify, change, or discontinue Courtesy Transportation at any time and to resolve all questions of claim eligibility pursuant to the terms and conditions described herein at its sole discretion.*

### **Collision Damage Repair**

If your vehicle is involved in a collision and it is damaged, have the damage repaired by a qualified technician using the proper equipment and quality replacement parts. Poorly performed collision repairs will diminish your vehicle's resale value, and safety performance can be compromised in subsequent collisions.

## Collision Parts

Genuine GM Collision parts are new parts made with the same materials and construction methods as the parts with which your vehicle was originally built. Genuine GM Collision parts are your best choice to ensure that your vehicle's designed appearance, durability and safety are preserved. The use of Genuine GM parts can help maintain your GM New Vehicle Warranty.

Recycled original equipment parts may also be used for repair. These parts are typically removed from vehicles that were total losses in prior crashes. In most cases, the parts being recycled are from undamaged sections of the vehicle. A recycled original equipment GM part, may be an acceptable choice to maintain your vehicle's originally designed appearance and safety performance, however, the history of these parts is not known. Such parts are not covered by your GM New Vehicle Limited Warranty, and any related failures are not covered by that warranty.

Aftermarket collision parts are also available. These are made by companies other than GM and may not have been tested for your vehicle. As a result, these parts may fit poorly, exhibit premature durability/corrosion problems, and may not perform properly in subsequent collisions. Aftermarket parts are not covered by your GM New Vehicle Limited Warranty, and any vehicle failure related to such parts are not covered by that warranty.

## Repair Facility

GM also recommends that you choose a collision repair facility that meets your needs before you ever need collision repairs. Your GM dealer/retailer may have a collision repair center with GM-trained technicians and state of the art equipment, or be able to recommend a collision repair center that has GM-trained technicians and comparable equipment.

## Insuring Your Vehicle

Protect your investment in your GM vehicle with comprehensive and collision insurance coverage. There are significant differences in the quality of coverage afforded by various insurance policy terms. Many insurance policies provide reduced protection to your GM vehicle by limiting compensation for damage repairs by using aftermarket collision parts. Some insurance companies will not specify aftermarket collision parts. When purchasing insurance, we recommend that you assure your vehicle will be repaired with GM original equipment collision parts. If such insurance coverage is not available from your current insurance carrier, consider switching to another insurance carrier.

If your vehicle is leased, the leasing company may require you to have insurance that assures repairs with Genuine GM Original Equipment Manufacturer (OEM) parts or Genuine Manufacturer replacement parts. Read your lease carefully, as you may be charged at the end of your lease for poor quality repairs.

## If a Crash Occurs

Here is what to do if you are involved in a crash.

- Try to relax and then check to make sure you are all right. If you are uninjured, make sure that no one else in your vehicle, or the other vehicle, is injured.
- If there has been an injury, call emergency services for help. Do not leave the scene of a crash until all matters have been taken care of. Move your vehicle only if its position puts you in danger or you are instructed to move it by a police officer.
- Give only the necessary and requested information to police and other parties involved in the crash. Do not discuss your personal condition, mental frame of mind, or anything unrelated to the crash. This will help guard against post-crash legal action.
- If you need roadside assistance, call GM Roadside Assistance. See *Roadside Service on page 8-7* for more information.
- If your vehicle cannot be driven, know where the towing service will be taking it. Get a card from the tow truck operator or write down the driver's name, the service's name, and the phone number.
- Remove any valuables from your vehicle before it is towed away. Make sure this includes your insurance information and registration if you keep these items in your vehicle.
- Gather the important information you will need from the other driver. Things like name, address, phone number, driver's license number, vehicle license plate, vehicle make, model and model year, Vehicle Identification Number (VIN), insurance company and policy number, and a general description of the damage to the other vehicle.
- If possible, call your insurance company from the scene of the crash. They will walk you through the information they will need. If they ask for a police report, phone or go to the police department headquarters the next day and you can get a copy of the report for a nominal fee. In some states/provinces with "no fault" insurance laws, a report may not be necessary. This is especially true if there are no injuries and both vehicles are driveable.
- Choose a reputable collision repair facility for your vehicle. Whether you select a GM dealer/retailer or a private collision repair facility to fix the damage, make sure you are comfortable with them. Remember, you will have to feel comfortable with their work for a long time.
- Once you have an estimate, read it carefully and make sure you understand what work will be performed on your vehicle. If you have a question, ask for an explanation. Reputable shops welcome this opportunity.

## Managing the Vehicle Damage Repair Process

In the event that your vehicle requires damage repairs, GM recommends that you take an active role in its repair. If you have a pre-determined repair facility of choice, take your vehicle there, or have it towed there. Specify to the facility that any required replacement collision parts be original equipment parts, either new Genuine GM parts or recycled original GM parts. Remember, recycled parts will not be covered by your GM vehicle warranty.

Insurance pays the bill for the repair, but you must live with the repair. Depending on your policy limits, your insurance company may initially value the repair using aftermarket parts. Discuss this with your repair professional, and insist on Genuine GM parts. Remember if your vehicle is leased you may be obligated to have the vehicle repaired with Genuine GM parts, even if your insurance coverage does not pay the full cost.

If another party's insurance company is paying for the repairs, you are not obligated to accept a repair valuation based on that insurance company's collision policy repair limits, as you have no contractual limits with that company. In such cases, you can have control of the repair and parts choices as long as cost stays within reasonable limits.

## Reporting Safety Defects

### Reporting Safety Defects to the United States Government

If you believe that your vehicle has a defect which could cause a crash or could cause injury or death, you should immediately inform the National Highway Traffic Safety Administration (NHTSA) in addition to notifying General Motors.

If NHTSA receives similar complaints, it may open an investigation, and if it finds that a safety defect exists in a group of vehicles, it may order a recall and remedy campaign. However, NHTSA cannot become involved in individual problems between you, your dealer/retailer, or General Motors.

To contact NHTSA, you may call the Vehicle Safety Hotline toll-free at 1-888-327-4236 (TTY: 1-800-424-9153); go to <http://www.safercar.gov>; or write to:

Administrator, NHTSA  
1200 New Jersey Avenue, S.E.  
Washington D.C., 20590

You can also obtain other information about motor vehicle safety from <http://www.safercar.gov>.

## Reporting Safety Defects to the Canadian Government

If you live in Canada, and you believe that your vehicle has a safety defect, notify Transport Canada immediately, in addition to notifying General Motors of Canada Limited. Call them at 1-800-333-0510 or write to:

Transport Canada  
Road Safety Branch  
2780 Sheffield Road  
Ottawa, Ontario K1B 3V9

## Reporting Safety Defects to General Motors

In addition to notifying NHTSA (or Transport Canada) in a situation like this, please notify General Motors.

Call 1-800-458-8006, or write:

Cadillac Customer Assistance Center  
Cadillac Motor Car Division  
P.O. Box 33169  
Detroit, MI 48232-5169

In Canada, call 1-888-446-2000, or write:

Canadian Cadillac Customer Communication Centre,  
CA1-163-005  
General Motors of Canada Limited  
1908 Colonel Sam Drive  
Oshawa, Ontario L1H 8P7

## Service Publications Ordering Information

### Service Manuals

Service Manuals have the diagnosis and repair information on engines, transmission, axle suspension, brakes, electrical, steering, body, etc.

### Service Bulletins

Service Bulletins give additional technical service information needed to knowledgeably service General Motors cars and trucks. Each bulletin contains instructions to assist in the diagnosis and service of your vehicle.

### Owner Information

Owner publications are written specifically for owners and intended to provide basic operational information about the vehicle. The owner manual includes the Maintenance Schedule for all models.

In-Portfolio: Includes a Portfolio, Owner Manual, and Warranty Booklet.

RETAIL SELL PRICE: \$35.00 (U.S.) plus processing fee

Without Portfolio: Owner Manual only.

RETAIL SELL PRICE: \$25.00 (U.S.) plus processing fee

## Current and Past Model Order Forms

Technical Service Bulletins and Manuals are available for current and past model GM vehicles. To request an order form, specify year and model name of the vehicle.

**ORDER TOLL FREE: 1-800-551-4123**  
**Monday-Friday 8:00 AM - 6:00 PM**  
**Eastern Time**

For Credit Card Orders Only  
(VISA-MasterCard-Discover), visit Helm, Inc. on the  
World Wide Web at: [helminc.com](http://helminc.com)

Or you can write to:

Helm, Incorporated  
P.O. Box 07130  
Detroit, MI 48207

Prices are subject to change without notice and without incurring obligation. Allow ample time for delivery.

Note to Canadian Customers: All listed prices are quoted in U.S. funds. Canadian residents are to make checks payable in U.S. funds.

## Vehicle Data Recording and Privacy

Your GM vehicle has a number of sophisticated computers that record information about the vehicle's performance and how it is driven. For example, your vehicle uses computer modules to monitor and control engine and transmission performance, to monitor the conditions for airbag deployment and deploy airbags in a crash and, if so equipped, to provide antilock braking to help the driver control the vehicle. These modules may store data to help your dealer/retailer technician service your vehicle. Some modules may also store data about how you operate the vehicle, such as rate of fuel consumption or average speed. These modules may also retain the owner's personal preferences, such as radio pre-sets, seat positions, and temperature settings.

## Event Data Recorders

This vehicle has an Event Data Recorder (EDR). The main purpose of an EDR is to record, in certain crash or near crash-like situations, such as an airbag deployment or hitting a road obstacle, data that will assist in understanding how a vehicle's systems performed. The EDR is designed to record data related to vehicle dynamics and safety systems for a short period of time, typically 30 seconds or less. The EDR in this vehicle is designed to record such data as:

- How various systems in your vehicle were operating
- Whether or not the driver and passenger safety belts were buckled/fastened
- How far, if at all, the driver was pressing the accelerator and/or brake pedal
- How fast the vehicle was traveling

This data can help provide a better understanding of the circumstances in which crashes and injuries occur.

**Important:** EDR data is recorded by your vehicle only if a non-trivial crash situation occurs; no data is recorded by the EDR under normal driving conditions and no personal data (e.g., name, gender, age, and crash location) is recorded. However, other parties, such as law enforcement, could combine the EDR data with the type of personally identifying data routinely acquired during a crash investigation.

To read data recorded by an EDR, special equipment is required, and access to the vehicle or the EDR is needed. In addition to the vehicle manufacturer, other parties, such as law enforcement, that have the special equipment, can read the information if they have access to the vehicle or the EDR.

GM will not access this data or share it with others except: with the consent of the vehicle owner or, if the vehicle is leased, with the consent of the lessee; in response to an official request of police or similar government office; as part of GM's defense of litigation through the discovery process; or, as required by law. Data that GM collects or receives may also be used for GM research needs or may be made available to others for research purposes, where a need is shown and the data is not tied to a specific vehicle or vehicle owner.

## OnStar®

If your vehicle has OnStar and you subscribe to the OnStar services, please refer to the OnStar Terms and Conditions for information on data collection and use. See also *OnStar® System on page 2-42* in this manual for more information.

## Navigation System

If your vehicle has a navigation system, use of the system may result in the storage of destinations, addresses, telephone numbers, and other trip information. Refer to the navigation system operating manual for information on stored data and for deletion instructions.

## Radio Frequency Identification (RFID)

RFID technology is used in some vehicles for functions such as tire pressure monitoring and ignition system security, as well as in connection with conveniences such as key fobs for remote door locking/unlocking and starting, and in-vehicle transmitters for garage door openers. RFID technology in GM vehicles does not use or record personal information or link with any other GM system containing personal information.



# A

Accessories and Modifications .....	6-3
Accessory Power Outlets .....	3-34
Adaptive Cruise Control .....	3-14
Adaptive Forward Lighting System .....	3-28
Adding Equipment to Your Airbag-Equipped Vehicle .....	1-50
Additives, Fuel .....	6-6
Add-On Electrical Equipment .....	6-82
Air Cleaner/Filter, Engine .....	6-20
Air Conditioning .....	3-36
Airbag	
Passenger Status Indicator .....	3-45
Readiness Light .....	3-44
Airbag System .....	1-38
Adding Equipment to Your Airbag-Equipped Vehicle .....	1-50
How Does an Airbag Restrain? .....	1-43
Passenger Sensing System .....	1-45
Servicing Your Airbag-Equipped Vehicle .....	1-50
What Makes an Airbag Inflate? .....	1-43
What Will You See After an Airbag Inflates? ....	1-44
When Should an Airbag Inflate? .....	1-42
Where Are the Airbags? .....	1-40
Antenna, Diversity Antenna System .....	3-91

Antenna, XM™ Satellite Radio Antenna System .....	3-91
Antilock Brake System (ABS) .....	5-5
Antilock Brake, System Warning Light .....	3-48
Appearance Care	
Aluminum or Chrome-Plated Wheels .....	6-79
Care of Safety Belts .....	6-76
Chemical Paint Spotting .....	6-81
Cleaning Exterior Lamps/Lenses .....	6-77
Fabric/Carpet .....	6-75
Fiberglass Springs .....	6-81
Finish Care .....	6-78
Finish Damage .....	6-80
Instrument Panel, Vinyl, and Other Plastic Surfaces .....	6-76
Interior Cleaning .....	6-74
Leather .....	6-75
Sheet Metal Damage .....	6-80
Speaker Covers .....	6-76
Tires .....	6-80
Underbody Maintenance .....	6-80
Washing Your Vehicle .....	6-77
Weatherstrips .....	6-77
Windshield and Wiper Blades .....	6-78
Wood Panels .....	6-76
Appointments, Scheduling Service .....	8-10

Ashtray .....	3-35
Audio System .....	3-76, 4-52
Audio Steering Wheel Controls .....	3-88
Care of Your CD Player .....	3-91
Care of Your CDs .....	3-91
Diversity Antenna System .....	3-91
Radio Reception .....	3-90
Theft-Deterrent Feature .....	3-88
XM™ Satellite Radio Antenna System .....	3-91
Automatic Door Lock .....	2-13
Automatic Transmission	
Fluid .....	6-21
Operation .....	2-28
Avoid Point/Area, Edit .....	4-25

## B

Battery .....	6-35
Exterior Lighting Battery Saver .....	3-30
Run-Down Protection .....	3-31
Bluetooth® .....	3-77
Brake	
Emergencies .....	5-6
Brake Fluid .....	6-32
Brakes .....	6-32
System Warning Light .....	3-47

Braking .....	5-4
Braking in Emergencies .....	5-6
Break-In, New Vehicle .....	2-24
Bulb Replacement .....	6-45
Headlamp Aiming .....	6-42
Buying New Tires .....	6-62

## C

California Fuel .....	6-6
California Perchlorate Materials Requirements .....	6-4
California Proposition 65 Warning .....	6-4
Canadian Owners .....	iii
Capacities and Specifications .....	6-90
Carbon Monoxide .....	2-14, 2-36, 5-18
Care of	
Safety Belts .....	6-76
Your CD Player .....	3-91
Your CDs .....	3-91
CD	
Six-Disc Changer .....	4-65
CD/DVD Player .....	4-68
Center Console Storage Area .....	2-53
Chains, Tire .....	6-68
Charging System Light .....	3-46

Check		Cleaning (cont.)	
Engine Lamp .....	3-50	Washing Your Vehicle .....	6-77
Checking Things Under the Hood .....	6-10	Weatherstrips .....	6-77
Chemical Paint Spotting .....	6-81	Windshield and Wiper Blades .....	6-78
Child Restraints		Wood Panels .....	6-76
Child Restraint Systems .....	1-31	Climate Control System	
Infants and Young Children .....	1-27	Air Filter, Passenger Compartment .....	3-41
Lower Anchors and Tethers for Children .....	1-33	Dual .....	3-36
Older Children .....	1-23	Outlet Adjustment .....	3-40
Securing a Child Restraint in the		Collision Damage Repair .....	8-11
Right Front Seat Position .....	1-34	Competitive Driving, Racing or Other .....	5-14
Cigarette Lighter .....	3-35	Control of a Vehicle .....	5-3
Cleaning		Convenience Net .....	2-54
Aluminum or Chrome-Plated Wheels .....	6-79	Coolant	
Exterior Lamps/Lenses .....	6-77	Engine .....	6-23
Fabric/Carpet .....	6-75	Engine Temperature Gage .....	3-49
Fiberglass Springs .....	6-81	Cooled Seats .....	1-3
Finish Care .....	6-78	Cooling System .....	6-22
Instrument Panel, Vinyl, and Other Plastic		Courtesy Lamps .....	3-30
Surfaces .....	6-76	Cruise Control .....	3-11
Interior .....	6-74	Cupholders .....	2-53
Leather .....	6-75	Customer Assistance Information	
Speaker Covers .....	6-76	Courtesy Transportation .....	8-10
Tires .....	6-80	Customer Assistance for Text	
Underbody Maintenance .....	6-80	Telephone (TTY) Users .....	8-6
		Customer Assistance Offices .....	8-6

Customer Assistance Information (cont.)	
Customer Satisfaction Procedure .....	8-2
GM Mobility Reimbursement Program .....	8-7
Reporting Safety Defects to General Motors .....	8-15
Reporting Safety Defects to the Canadian Government .....	8-15
Reporting Safety Defects to the United States Government .....	8-14
Roadside Service .....	8-7
Service Publications Ordering Information .....	8-15

## D

Database Coverage Explanations .....	4-52
Daytime Running Lamp .....	3-27
Defensive Driving .....	5-2
Diversity Antenna System .....	3-91
Doing Your Own Service Work .....	6-4
Door	
Automatic Door Lock .....	2-13
Locks .....	2-10
Power Door Locks .....	2-13
Programmable Automatic Door Unlock .....	2-13
Driver Information Center (DIC) .....	3-57
DIC Operation and Displays .....	3-57
DIC Vehicle Personalization .....	3-72
DIC Warnings and Messages .....	3-60
Other Messages .....	3-70

Driving	
At Night .....	5-14
Before a Long Trip .....	5-16
Defensive .....	5-2
Drunken .....	5-2
Highway Hypnosis .....	5-16
Hill and Mountain Roads .....	5-17
In Rain and on Wet Roads .....	5-15
Rocking Your Vehicle to Get it Out .....	5-20
Winter .....	5-18
Dual Climate Control System .....	3-36
DVD, CD Player .....	4-68

## E

Edit	
Avoid Point/Area .....	4-25
Memory Point .....	4-19
Waypoint .....	4-23
EDR .....	8-16
Electrical System	
Add-On Equipment .....	6-82
Fuses and Circuit Breakers .....	6-83
Instrument Panel Fuse Block .....	6-83
Power Windows and Other Power Options .....	6-83
Underhood Fuse Block .....	6-87
Windshield Wiper Fuses .....	6-83

Engine	
Air Cleaner/Filter .....	6-20
Check and Service Engine Soon Lamp .....	3-50
Coolant .....	6-23
Coolant Temperature Gage .....	3-49
Drive Belt Routing .....	7-14
Engine Compartment Overview .....	6-12
Exhaust .....	2-36
Oil .....	6-15
Oil Life System .....	6-18
Oil Pressure Gage .....	3-54
Overheated Protection Operating Mode .....	6-29
Overheating .....	6-27
Starting .....	2-26
Enter Destination .....	4-27
Entry/Exit Lighting .....	3-30
Event Data Recorders .....	8-17
Extender, Safety Belt .....	1-23
Exterior Lamps .....	3-26
Exterior Lighting Battery Saver .....	3-30

## F

Filter	
Engine Air Cleaner .....	6-20
Finish Damage .....	6-80
Flashers, Hazard Warning .....	3-6

Flash-to-Pass .....	3-8
Flat Tire .....	6-72
Floor Mats .....	2-53
Fluid	
Automatic Transmission .....	6-21
Power Steering .....	6-30
Windshield Washer .....	6-31
Fog Lamp	
Fog .....	3-28
Fog Lamp Light .....	3-55
Fuel .....	6-5
Additives .....	6-6
California Fuel .....	6-6
Filling a Portable Fuel Container .....	6-10
Filling the Tank .....	6-8
Fuels in Foreign Countries .....	6-7
Gage .....	3-56
Gasoline Octane .....	6-5
Gasoline Specifications .....	6-6
Fuses	
Fuses and Circuit Breakers .....	6-83
Instrument Panel Fuse Block .....	6-83
Underhood Fuse Block .....	6-87
Windshield Wiper .....	6-83

## G

Gage	
Engine Coolant Temperature .....	3-49
Engine Oil Pressure .....	3-54
Fuel .....	3-56
Speedometer .....	3-43
Tachometer .....	3-43
Voltmeter Gage .....	3-46
Garage Door Opener .....	2-45
Gasoline	
Octane .....	6-5
Specifications .....	6-6
Getting Started	
Getting Started, Navigation .....	4-4
Global Positioning System (GPS) .....	4-49
Glove Box .....	2-53
GM Mobility Reimbursement Program .....	8-7

## H

Hazard Warning Flashers .....	3-6
Headlamp	
Aiming .....	6-42
Vertical Aiming .....	6-43
Headlamps	
Adaptive Forward Lighting System .....	3-28
Bulb Replacement .....	6-45

Headlamps (cont.)	
Daytime Running Lamp .....	3-27
Exterior Lamps .....	3-26
Flash-to-Pass .....	3-8
High/Low Beam Changer .....	3-8
On Reminder .....	3-27
Washer .....	3-11
Wiper Activated .....	3-27
Head-Up Display (HUD) .....	3-31
Heated Seats .....	1-3
Heated Steering Wheel .....	3-7
Heater .....	3-36
Highbeam On Light .....	3-55
Highway Hypnosis .....	5-16
Hill and Mountain Roads .....	5-17
Hood	
Checking Things Under .....	6-10
Release .....	6-11
Horn .....	3-6
How to Wear Safety Belts Properly .....	1-11

## I

Ignition Positions .....	2-24
Immobilizer .....	2-22
Immobilizer Operation .....	2-23
Infants and Young Children, Restraints .....	1-27
Inflation - Tire Pressure .....	6-54

Instrument Panel	
Brightness .....	3-30
Cluster .....	3-42
Overview .....	3-4

## J

Jump Starting .....	6-36
---------------------	------

## K

Keyless Access System .....	2-4, 4-48
Keyless Access System, Operation .....	2-5
Keys .....	2-3

## L

Labeling, Tire Sidewall .....	6-48
Lamp	
Malfunction Indicator .....	3-50
Lamps	
Courtesy .....	3-30
Exterior Lighting Battery Saver .....	3-30
Reading .....	3-30
Twilight Sentinel® .....	3-29

Lap-Shoulder Belt .....	1-20
LATCH System for Child Restraints .....	1-33
Lifting the Vehicle, Tires .....	6-68
Light	
Airbag Readiness .....	3-44
Antilock Brake System (ABS) Warning .....	3-48
Brake System Warning .....	3-47
Charging System .....	3-46
Fog Lamp .....	3-55
Highbeam On .....	3-55
Lights On Reminder .....	3-55
Passenger Airbag Status Indicator .....	3-45
Safety Belt Reminders .....	3-44
Security .....	3-55
StabiliTrak® /Traction Control System (TCS)	
Warning Light .....	3-48
Tire Pressure .....	3-50
Lighting	
Entry/Exit .....	3-30
Lights	
Exterior Lamps .....	3-26
Flash-to-Pass .....	3-8
High/Low Beam Changer .....	3-8
On Reminder .....	3-27
Limited-Slip Rear Axle .....	5-10
Loading Your Vehicle .....	5-21
Lockout Protection .....	2-13

Locks	
Automatic Door Lock .....	2-13
Door .....	2-10
Lockout Protection .....	2-13
Power Door .....	2-13
Programmable Automatic Door Unlock .....	2-13
Loss of Control .....	5-12
Lower Anchors and Tethers for Children .....	1-33
Lowering the Retractable Hardtop .....	2-55
Lumbar	
Power Controls .....	1-2

## M

Magnetic Ride Control .....	5-10
Maintenance Schedule	
Additional Required Services .....	7-6
At Each Fuel Fill .....	7-9
At Least Once a Month .....	7-9
At Least Once a Year .....	7-10
Introduction .....	7-2
Maintenance Footnotes .....	7-7
Maintenance Record .....	7-15
Maintenance Replacement Parts .....	7-13
Maintenance Requirements .....	7-2
Owner Checks and Services .....	7-9
Recommended Fluids and Lubricants .....	7-11

Maintenance Schedule (cont.)	
Scheduled Maintenance .....	7-4
Using .....	7-3
Your Vehicle and the Environment .....	7-2
Malfunction Indicator Lamp .....	3-50
Maps .....	4-38
Memory Point, Edit .....	4-19
Memory Seat, Mirrors, Steering Wheel Controls .....	1-3
Menu	
Setup .....	4-12
Message	
DIC Warnings and Messages .....	3-60
Mirrors	
Automatic Dimming Rearview .....	2-38
Outside Automatic Dimming Mirror .....	2-39
Outside Convex Mirror .....	2-39
Outside Heated Mirrors .....	2-39
Outside Power Mirrors .....	2-38
Park Assist .....	2-39
MyGMLink.com .....	8-5

## N

Navigation .....	4-2, 4-4
Using the System .....	4-10
Navigation System, Privacy .....	8-18
New Vehicle Break-In .....	2-24



## O

Odometer .....	3-43
Odometer, Trip .....	3-43
Off-Road Recovery .....	5-12
Oil	
Engine .....	6-15
Engine Oil Pressure Gage .....	3-54
Life Indicator .....	3-76
Oil, Engine Oil Life System .....	6-18
Older Children, Restraints .....	1-23
Online Owner Center .....	8-5
OnStar, Privacy .....	8-18
OnStar <sup>®</sup> System .....	4-48
OnStar <sup>®</sup> System, see OnStar <sup>®</sup> Manual .....	2-42
Operation, Universal Home Remote System .....	2-46
Ordering	
Map DVDs .....	4-52
Outlet Adjustment .....	3-40
Outlets	
Accessory Power .....	3-34
Outside	
Automatic Dimming Mirror .....	2-39
Convex Mirror .....	2-39
Heated Mirrors .....	2-39
Power Mirrors .....	2-38

Overheated Engine Protection	
Operating Mode .....	6-29
Owner Checks and Services .....	7-9
Owners, Canadian .....	iii

## P

Paint, Damage .....	6-80
Park	
Shifting Into .....	2-33
Shifting Out of .....	2-35
Park Aid .....	2-40
Park Assist Mirror .....	2-39
Park Brake .....	2-32
Parking	
Assist .....	2-40
Over Things That Burn .....	2-35
Passenger Airbag Status Indicator .....	3-45
Passenger Compartment Air Filter .....	3-41
Passenger Sensing System .....	1-45
Passing .....	5-12
Perchlorate Materials Requirements, California .....	6-4
Phone	
Bluetooth <sup>®</sup> .....	3-77
Plan Route .....	4-18

Power	
Door Locks .....	2-13
Electrical System .....	6-83
Lumbar Controls .....	1-2
Reclining Seatbacks .....	1-4
Retained Accessory .....	2-25
Seat .....	1-2
Steering Fluid .....	6-30
Tilt Wheel and Telescopic Steering Column .....	3-6
Windows .....	2-18
Privacy .....	8-16
Event Data Recorders .....	8-17
Navigation System .....	8-18
OnStar .....	8-18
Radio Frequency Identification .....	8-18
Problems with Route Guidance .....	4-51
Programmable Automatic Door Unlock .....	2-13

## R

Racing or Other Competitive Driving .....	5-14
Radio .....	4-52
Personalization with Home and Away Feature .....	4-73
Radio Frequency Identification (RFID), Privacy .....	8-18

Radios	
Care of Your CD Player .....	3-91
Care of Your CDs .....	3-91
Reception .....	3-90
Theft-Deterrent .....	3-88
Rainsense™ Wipers .....	3-9
Raising the Retractable Hardtop .....	2-56
Reading Lamps .....	3-30
Rear Axle .....	6-41
Limited-Slip .....	5-10
Rear Storage Area .....	2-54
Rearview Mirror, Automatic Dimming .....	2-38
Reclining Seatbacks, Power .....	1-4
Recommended Fluids and Lubricants .....	7-11
Recreational Vehicle Towing .....	5-26
Remote, Keyless Access System .....	2-4, 4-48
Replacement Parts, Maintenance .....	7-13
Replacement, Windshield .....	6-45
Reporting Safety Defects	
Canadian Government .....	8-15
General Motors .....	8-15
United States Government .....	8-14
Restraint System Check	
Checking the Restraint Systems .....	1-52
Replacing Restraint System Parts After a Crash .....	1-53

Retained Accessory Power .....	2-25
Retractable Hardtop .....	2-54
Lowering .....	2-55
Raising .....	2-56
Roadside	
Service .....	8-7
Rocking Your Vehicle to Get it Out .....	5-20
Route Preference .....	4-36
Routing, Engine Drive Belt .....	7-14
Run-Flat Tires .....	6-52
Running the Vehicle While Parked .....	2-37

## S

Safety Belt Reminders .....	3-44
Safety Belts	
Care of .....	6-76
How to Wear Safety Belts Properly .....	1-11
Lap-Shoulder Belt .....	1-20
Safety Belt Extender .....	1-23
Safety Belt Use During Pregnancy .....	1-22
Safety Belts Are for Everyone .....	1-6
Safety Warnings and Symbols .....	iv
Scheduled Maintenance .....	7-4
Seats	
Heated and Cooled Seats .....	1-3
Memory, Mirrors .....	1-3

Seats (cont.)	
Power Lumbar .....	1-2
Power Reclining Seatbacks .....	1-4
Power Seats .....	1-2
Securing a Child Restraint	
Right Front Seat Position .....	1-34
Security Light .....	3-55
Service .....	6-3
Accessories and Modifications .....	6-3
Adding Equipment to the Outside of the Vehicle .....	6-5
California Perchlorate Materials Requirements .....	6-4
California Proposition 65 Warning .....	6-4
Doing Your Own Work .....	6-4
Engine Soon Lamp .....	3-50
Publications Ordering Information .....	8-15
Service, Scheduling Appointments .....	8-10
Service Your Airbag-Equipped Vehicle .....	1-50
Setup Menu .....	4-12
Sheet Metal Damage .....	6-80
Shifting Into Park .....	2-33
Shifting Out of Park .....	2-35
Signals, Turn and Lane-Change .....	3-7
Six-Disc CD Changer .....	4-65
Specifications, Capacities .....	6-90
Speedometer .....	3-43
Stabilitrak® System .....	5-6

StabiliTrak®/TCS Warning Light .....	3-48
Starting the Engine .....	2-26
Steering .....	5-10
Steering Wheel Controls, Audio .....	3-88
Steering Wheel Controls, Memory .....	1-3
Steering Wheel, Heated .....	3-7
Steering Wheel, Power Tilt Wheel and Telescopic Steering Column .....	3-6
Storage Areas	
Center Console Storage Area .....	2-53
Convenience Net .....	2-54
Cupholders .....	2-53
Glove Box .....	2-53
Rear Storage Area .....	2-54
Stuck in Sand, Mud, Ice, or Snow .....	5-20
Sun Visors .....	2-20
Symbols .....	4-43
System Needs Service, If .....	4-51
System Overview	
Overview, Navigation System .....	4-2

## T

Tachometer .....	3-43
Telescopic Steering Column, Power Tilt Wheel .....	3-6
Theft - Deterrent System .....	2-20
Theft-Deterrent, Radio .....	3-88

Theft-Deterrent Systems .....	2-20
Immobilizer .....	2-22
Immobilizer Operation .....	2-23
Tire	
Pressure Light .....	3-50
Tires .....	6-46
Aluminum or Chrome-Plated Wheels, Cleaning .....	6-79
Buying New Tires .....	6-62
Chains .....	6-68
Cleaning .....	6-80
Different Size .....	6-63
If a Tire Goes Flat .....	6-72
Inflation - Tire Pressure .....	6-54
Inspection and Rotation .....	6-60
Lifting the Vehicle .....	6-68
Pressure Monitor Operation .....	6-57
Pressure Monitor System .....	6-55
Run-Flat .....	6-52
Tire Sidewall Labeling .....	6-48
Tire Terminology and Definitions .....	6-50
Uniform Tire Quality Grading .....	6-64
Wheel Alignment and Tire Balance .....	6-65
Wheel Replacement .....	6-66
When It Is Time for New Tires .....	6-61
Winter Tires .....	6-47

Towing	
Recreational Vehicle .....	5-26
Towing a Trailer .....	5-26
Your Vehicle .....	5-26
Traction	
Control System (TCS) .....	5-8
Limited-Slip Rear Axle .....	5-10
Magnetic Ride Control .....	5-10
Stabilitrak <sup>®</sup> System .....	5-6
Transmission	
Fluid, Automatic .....	6-21
Transmission Operation, Automatic .....	2-28
Trip Computer	
Oil Life Indicator .....	3-76
Trip Odometer .....	3-43
Trunk .....	2-14
Turn and Lane-Change Signals .....	3-7
Turn Signal/Multifunction Lever .....	3-7
Twilight Sentinel <sup>®</sup> .....	3-29

## U

Ultrasonic Rear Parking Assist (URPA) .....	2-40
Uniform Tire Quality Grading .....	6-64
Universal Home Remote System .....	2-45
Operation .....	2-46

## V

Valet Lockout Switch .....	2-22
Vehicle	
Control .....	5-3
Loading .....	5-21
Running While Parked .....	2-37
Vehicle Data Recording and Privacy .....	8-16
Vehicle Identification	
Number (VIN) .....	6-81
Service Parts Identification Label .....	6-82
Vehicle Personalization	
DIC .....	3-72
Vehicle Positioning .....	4-50
Ventilation Adjustment .....	3-40
Visors .....	2-20
Voice Recognition .....	4-74
Voltmeter Gage .....	3-46

## W

Warning Lights, Gages, and Indicators .....	3-41
Warnings	
DIC Warnings and Messages .....	3-60
Hazard Warning Flashers .....	3-6
Safety and Symbols .....	iv

Washer, Headlamps .....	3-11
Waypoint, Edit .....	4-23
Wheels	
Alignment and Tire Balance .....	6-65
Different Size .....	6-63
Replacement .....	6-66
Windows .....	2-17
Power .....	2-18
Windshield	
Rainsense™ Wipers .....	3-9
Replacement .....	6-45
Washer .....	3-10
Washer Fluid .....	6-31
Wiper Blade Replacement .....	6-45

Windshield (cont.)	
Wiper Blades, Cleaning .....	6-78
Wiper Fuses .....	6-83
Wipers .....	3-8
Winter Driving .....	5-18
Winter Tires .....	6-47
Wiper Activated Headlamps .....	3-27

## X

XM™ Satellite Radio Antenna System .....	3-91
--	------

## Y

Your Vehicle and the Environment .....	7-2
--	-----