



The 1999 Cadillac Catera Owner's Manual

1-1 Seats and Restraint Systems

This section tells you how to use your seats and safety belts properly. It also explains the air bag system.

2-1 Features and Controls

This section explains how to start and operate your vehicle.

3-1 Comfort Controls and Audio Systems

This section tells you how to adjust the ventilation and comfort controls and how to operate your audio system.

4-1 Your Driving and the Road

Here you'll find helpful information and tips about the road and how to drive under different conditions.

5-1 Problems on the Road

This section tells you what to do if you have a problem while driving, such as a flat tire or overheated engine, etc.

6-1 Service and Appearance Care

Here the manual tells you how to keep your vehicle running properly and looking good.

7-1 Customer Assistance Information

This section tells you how to contact Cadillac for assistance and how to get service and owner publications. It also gives you information on "Reporting Safety Defects" on page 7-10.

8-1 Index

Here's an alphabetical listing of almost every subject in this manual. You can use it to quickly find something you want to read.



GENERAL MOTORS, GM and the GM Emblem, CADILLAC and the CADILLAC Crest & Wreath are registered trademarks of General Motors Corporation.

This manual includes the latest information at the time it was printed. We reserve the right to make changes in the product after that time without further notice. For vehicles first sold in Canada, substitute the name "General Motors of Canada Limited" for Cadillac Motor Car Division whenever it appears in this manual.

Please keep this manual in your vehicle, so it will be there if you ever need it when you're on the road. If you sell the vehicle, please leave this manual in it so the new owner can use it.

Litho in U.S.A.
Part No. 10407711 B First Edition



We support voluntary technician certification.

For Canadian Owners Who Prefer a French Language Manual:

Aux propriétaires canadiens: Vous pouvez vous procurer un exemplaire de ce guide en français chez votre concessionnaire ou au:

DGN Marketing Services Ltd.
1577 Meyerside Dr.
Mississauga, Ontario L5T 1B9

© Copyright General Motors Corporation 1998
All Rights Reserved

CATERA™ **THE CADDY THAT ZIGS.**

2 0 0 0 E D I T I O N

Congratulations.

Cadillac has been designing and building luxury cars for 97 years.

**With the Catera, you have selected the first Cadillac ever to
be engineered and manufactured in Germany.**

**It is a unique expression of Cadillac luxury with a sensibility to
European ride and handling. With proper care, your Catera will deliver
mile after mile of exciting, performance-oriented luxury driving.**

Drive safely and enjoy.

Luxury truly can be fun.

CATERA™

THE CADDY THAT ZIGS.™



How to Use this Manual

Many people read their owner's manual from beginning to end when they first receive their new vehicle. If you do this, it will help you learn about the features and controls for your vehicle. In this manual, you'll find that pictures and words work together to explain things quickly.

Index

A good place to look for what you need is the Index in back of the manual. It's an alphabetical list of what's in the manual, and the page number where you'll find it.

Safety Warnings and Symbols

You will find a number of safety cautions in this book. We use a box and the word CAUTION to tell you about things that could hurt you if you were to ignore the warning.

CAUTION:

These mean there is something that could hurt you or other people.

In the caution area, we tell you what the hazard is. Then we tell you what to do to help avoid or reduce the hazard. Please read these cautions. If you don't, you or others could be hurt.

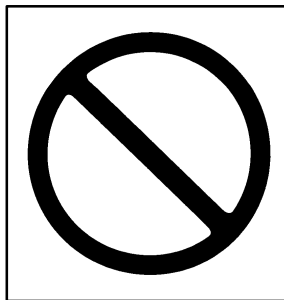

You will also find a circle with a slash through it in this book. This safety symbol means "Don't," "Don't do this" or "Don't let this happen."

Vehicle Damage Warnings

Also, in this book you will find these notices:

NOTICE:

These mean there is something that could damage your vehicle.

In the notice area, we tell you about something that can damage your vehicle. Many times, this damage would not be covered by your warranty, and it could be costly. But the notice will tell you what to do to help avoid the damage.

When you read other manuals, you might see CAUTION and NOTICE warnings in different colors or in different words.

You'll also see warning labels on your vehicle. They use the same words, CAUTION or NOTICE.

Vehicle Symbols

These are some of the symbols you may find on your vehicle.

For example, these symbols are used on an original battery:

CAUTION
POSSIBLE
INJURY



PROTECT
EYES BY
SHIELDING



CAUSTIC
BATTERY
ACID COULD
CAUSE
BURNS



AVOID
SPARKS OR
FLAMES



SPARK OR
FLAME
COULD
EXPLODE
BATTERY



These symbols are important for you and your passengers whenever your vehicle is driven:

DOOR LOCK
UNLOCK



FASTEN
SEAT
BELTS



POWER
WINDOW



AIR BAG



These symbols have to do with your lamps:

MASTER
LIGHTING
SWITCH



TURN
SIGNALS



PARKING
LAMPS



HAZARD
WARNING
FLASHER



DAYTIME
RUNNING
LAMPS



FOG LAMPS



These symbols are on some of your controls:

WINDSHIELD
WIPER



WINDSHIELD
WASHER



WINDSHIELD
DEFROSTER



REAR
WINDOW
DEFOGGER



VENTILATING
FAN



These symbols are used on warning and indicator lights:

ENGINE
COOLANT
TEMP



BATTERY
CHARGING
SYSTEM



BRAKE



COOLANT



ENGINE OIL
PRESSURE



ANTI-LOCK
BRAKES



Here are some other symbols you may see:

FUSE



LIGHTER



HORN



SPEAKER



FUEL





Section 1 Seats and Restraint Systems

Here you'll find information about the seats in your vehicle and how to use your safety belts properly. You can also learn about some things you should *not* do with air bags and safety belts.

1-2	Seats and Seat Controls	1-32	Safety Belt Pretensioners
1-10	Safety Belts: They're for Everyone	1-32	Rear Seat Passengers
1-15	Here are Questions Many People Ask About Safety Belts -- and the Answers	1-36	Children
1-16	How to Wear Safety Belts Properly	1-39	Child Restraints
1-16	Driver Position	1-49	Larger Children
1-23	Safety Belt Use During Pregnancy	1-52	Safety Belt Extender
1-24	Right Front Passenger Position	1-52	Checking Your Restraint Systems
1-24	Air Bag Systems	1-53	Replacing Restraint System Parts After a Crash

Seats and Seat Controls

This section tells you about the seats -- how to adjust them, and also about reclining front seatbacks, lumbar adjustments, heated seats and head restraints.

Manual Lumbar Support

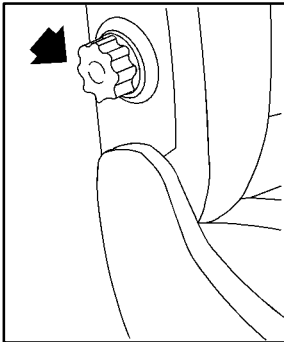

The lumbar control is located on the side of each front seatback closest to the door. The control provides additional support to your lower back and works independently of other seat controls.

Use the seat controls first to get the proper seating position. Then proceed with the lumbar adjustment.

The upper and lower seatback can be adjusted using the small hand-wheel control. Turn the control forward to increase support and rearward to decrease support.

Keep in mind that as your seating position changes, as it may during long trips, so should the position of the lumbar support. Adjust the seat as needed.

Power Seats

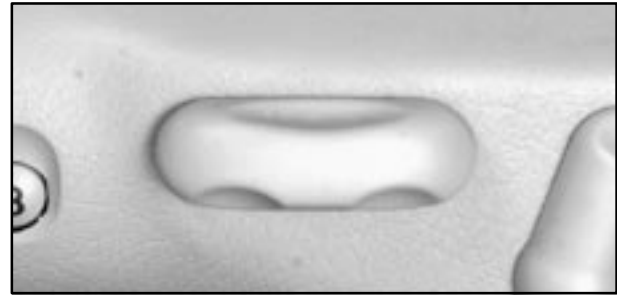

The power seat controls are located on the side of the front seat cushions closest to the door.

- Lift up or push down on the front of the control to adjust the front portion of the cushion up or down.
- Move the rear of the control up or down to adjust the rear portion of the cushion.
- To adjust the seat height, lift up or push down on the center of the control.
- To move the seat forward or rearward, slide the control in the desired direction.

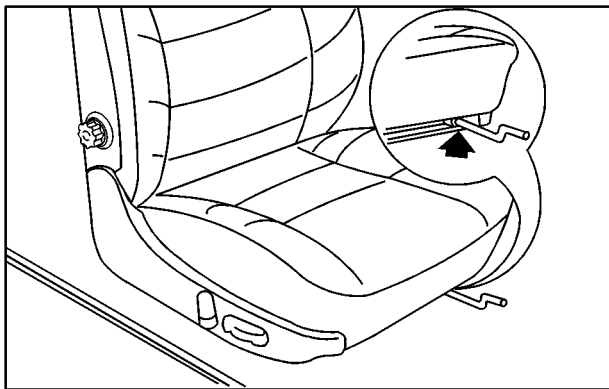

If a failure in the power supply system occurs, the power seats can be manually adjusted by inserting the crank handle into the slot located below the seat cushion, as shown in the above illustration. Turn the crank handle clockwise until you've reached your desired seating position.

Note: Manually moving the seat requires turning the crank handle many times.

The crank handle is provided in the tool kit located in the trunk. To access, pull the red handle on the passenger's side of the trunk.

Memory Seat and Mirrors



These buttons are located on the side of the driver's seat closest to the door. They are used to program and recall your desired memory settings.

To begin, adjust the driver's seat to a comfortable position. Also adjust the interior and exterior mirrors. Press memory button "M" and memory button "1" at the same time and hold for five seconds.

Seat and mirror positions may be programmed for two additional drivers by repeating the above steps and pressing memory button "2" or "3" instead of memory button "1."

If your vehicle is in PARK (P), you can recall mirror and seating positions by pressing and holding one of the three memory buttons. This will adjust the seat and mirrors to where you have previously programmed them. Seat and mirror movement is immediately stopped if the memory button is released or if a seat or mirror control is moved.

Also note that if you try to adjust the driver's memory seat and it doesn't move, try opening and closing the driver's door. This will re-activate power to the driver's seat as power to the driver's seat "times out" after 30 seconds. (Power to the passenger's seat is always present.)

Heated Front Seat (Option)



This control is located next to the radio on the center console. Press this button to turn on the heating element in the seat. The seatback and cushion are warmed until they match your body temperature.

A telltale light in the button reminds you that the heating system is in use. The heated seats can only be used when the ignition is turned on. The heating system shuts off automatically when the ignition is turned off.

Reclining Front Seatbacks



The power control is located on the side of each front seatback closest to the door. Press the control forward or rearward to adjust the seatback.



But don't have a seatback reclined if your vehicle is moving.

⚠ CAUTION:

Sitting in a reclined position when your vehicle is in motion can be dangerous. Even if you buckle up, your safety belts can't do their job when you're reclined like this.

The shoulder belt can't do its job because it won't be against your body. Instead, it will be in front of you. In a crash you could go into it, receiving neck or other injuries.

The lap belt can't do its job either. In a crash the belt could go up over your abdomen. The belt forces would be there, not at your pelvic bones. This could cause serious internal injuries.

For proper protection when the vehicle is in motion, have the seatback upright. Then sit well back in the seat and wear your safety belt properly.

Head Restraints

Slide the head restraint up or down so that the top of the restraint is closest to the top of your ears. This position reduces the chance of a neck injury in a crash.

The head restraints tilt forward and rearward also.

Removable Head Restraints

CAUTION:

If a head restraint is not installed on the seatback or stored in the vehicle properly, it could be thrown about the vehicle in a crash or sudden maneuver. People in the vehicle could be injured. Remove the head restraints only when you need to fold the seat, and be sure that the head restraints are stored securely in the trunk. When the seat is returned to the passenger position, be sure the head restraints are installed properly.



For more cargo space or to fold down the front passenger's seat, you may need to remove the head restraint. Press both release buttons at the top of the seatback and slide the head restraint out of the height adjust tubes.

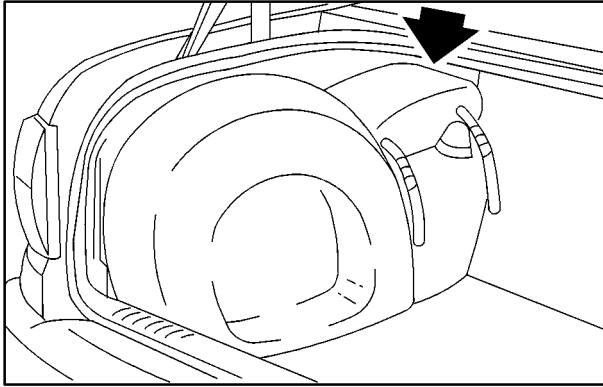

The head restraint should be stored securely on the driver's side of the trunk as shown.

Replace the head restraint when you have finished carrying cargo or when the passenger's seat is returned to its normal upright position.

Rear Seats

CAUTION:

A safety belt that is twisted or not properly attached won't provide the protection needed in a crash. A person wearing a twisted or not properly attached belt could be seriously injured. After raising the rear seatback, always check to be sure that the safety belt is not twisted and is properly attached.

Folding the Rear Seat

With the rear folding seatbacks, you can carry long cargo by folding down part or all of the rear seat. Before you can fold the rear seat, you need to unlatch the center buckle.



Insert a key or a similar object into the slot as shown to unlatch the buckle. Move the belt to the side so it is not in your way.



To unlock the rear seatback, press the pushbutton at the top of the seat and fold the seatback forward. To return the seat to the passenger position, lift up on the seatback and push it rearward until it latches. After returning the seat to the passenger position, pull forward on the seatback to make sure it is locked into place.



Return the safety belts to their original positions so they will be available for rear seat passengers to use. To do so, slide the buckle into the latch as shown.



The panel behind the rear seat armrest also folds. Turn the knob counterclockwise and pull the panel forward to gain access to the trunk. When finished using the panel, return it to its original position and turn the knob clockwise to secure.

Heated Rear Seat (Option)



The heated rear seat controls are located on the rear center console under the air outlets. Press the button once to turn on the heating system. Press the button again to turn the system off.

A telltale light in the button indicates the system is in use. The heated seats can only be used when the ignition is turned on. The heating system shuts off automatically when the ignition is turned off.

Safety Belts: They're for Everyone

This part of the manual tells you how to use safety belts properly. It also tells you some things you should not do with safety belts.

And it explains the air bag system.

CAUTION:

Don't let anyone ride where he or she can't wear a safety belt properly. If you are in a crash and you're not wearing a safety belt, your injuries can be much worse. You can hit things inside the vehicle or be ejected from it. You can be seriously injured or killed. In the same crash, you might not be if you are buckled up. Always fasten your safety belt, and check that your passengers' belts are fastened properly too.

 **CAUTION:**

It is extremely dangerous to ride in a cargo area, inside or outside of a vehicle. In a collision, people riding in these areas are more likely to be seriously injured or killed. Do not allow people to ride in any area of your vehicle that is not equipped with seats and safety belts. Be sure everyone in your vehicle is in a seat and using a safety belt properly.



Your vehicle has a light that comes on as a reminder to buckle up. (See “Safety Belt Reminder Light” in the Index.)

In most states and Canadian provinces, the law says to wear safety belts. Here’s why: *They work.*

You never know if you’ll be in a crash. If you do have a crash, you don’t know if it will be a bad one.

A few crashes are mild, and some crashes can be so serious that even buckled up a person wouldn’t survive. But most crashes are in between. In many of them, people who buckle up can survive and sometimes walk away. Without belts they could have been badly hurt or killed.

After more than 30 years of safety belts in vehicles, the facts are clear. In most crashes buckling up does matter ... a lot!

Why Safety Belts Work

When you ride in or on anything, you go as fast as it goes.

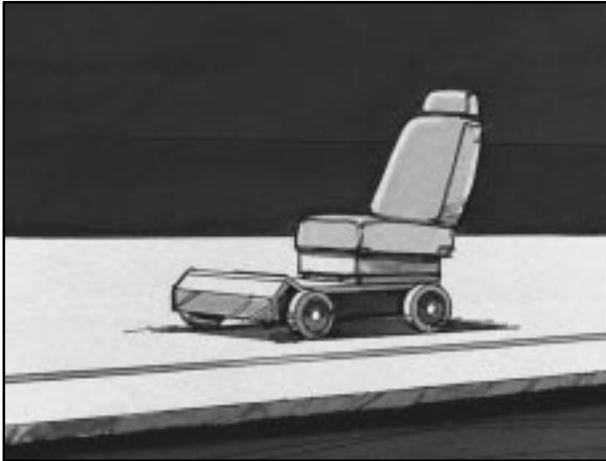

Take the simplest vehicle. Suppose it's just a seat on wheels.



Put someone on it.

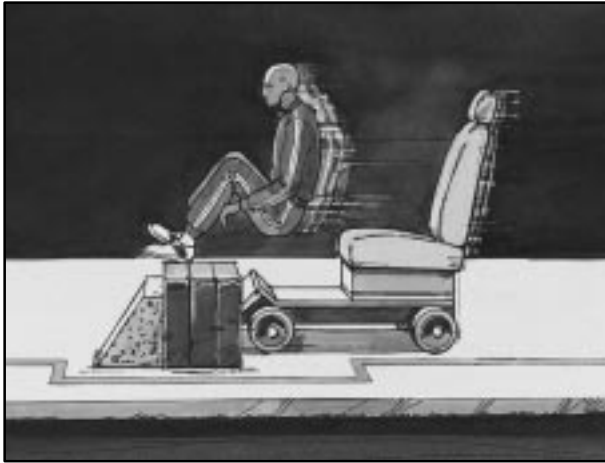

Get it up to speed. Then stop the vehicle. The rider doesn't stop.



The person keeps going until stopped by something. In a real vehicle, it could be the windshield ...

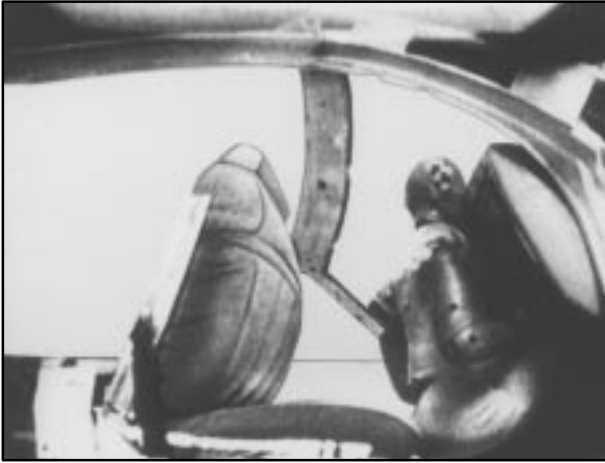

or the instrument panel ...



or the safety belts!

With safety belts, you slow down as the vehicle does. You get more time to stop. You stop over more distance, and your strongest bones take the forces. That's why safety belts make such good sense.

Here Are Questions Many People Ask About Safety Belts -- and the Answers

Q: Won't I be trapped in the vehicle after an accident if I'm wearing a safety belt?

A: You *could* be -- whether you're wearing a safety belt or not. But you can unbuckle a safety belt, even if you're upside down. And your chance of being conscious during and after an accident, so you *can* unbuckle and get out, is *much* greater if you are belted.

Q: If my vehicle has air bags, why should I have to wear safety belts?

A: Air bags are in many vehicles today and will be in most of them in the future. But they are supplemental systems only; so they work *with* safety belts -- not instead of them. Every air bag system ever offered for sale has required the use of safety belts. Even if you're in a vehicle that has air bags, you still have to buckle up to get the most protection. That's true not only in frontal collisions, but especially in side and other collisions.

Q: If I'm a good driver, and I never drive far from home, why should I wear safety belts?

A: You may be an excellent driver, but if you're in an accident -- even one that isn't your fault -- you and your passengers can be hurt. Being a good driver doesn't protect you from things beyond your control, such as bad drivers.

Most accidents occur within 25 miles (40 km) of home. And the greatest number of serious injuries and deaths occur at speeds of less than 40 mph (65 km/h).

Safety belts are for everyone.

How to Wear Safety Belts Properly

Adults

This part is only for people of adult size.

Be aware that there are special things to know about safety belts and children. And there are different rules for smaller children and babies. If a child will be riding in your vehicle, see the part of this manual called “Children.” Follow those rules for everyone’s protection.

First, you’ll want to know which restraint systems your vehicle has.

We’ll start with the driver position.

Driver Position

This part describes the driver’s restraint system.

Lap-Shoulder Belt

The driver has a lap-shoulder belt. Here’s how to wear it properly.

1. Close and lock the door.
2. Adjust the seat (to see how, see “Seats” in the Index) so you can sit up straight.



3. Pick up the latch plate and pull the belt across you. Don't let it get twisted.

The shoulder belt may lock if you pull the belt across you very quickly. If this happens, let the belt go back slightly to unlock it. Then pull the belt across you more slowly.

4. Push the latch plate into the buckle until it clicks.

Pull up on the latch plate to make sure it is secure. If the belt isn't long enough, see "Safety Belt Extender" at the end of this section.

Make sure the release button on the buckle is positioned so you would be able to unbuckle the safety belt quickly if you ever had to.



5. To make the lap part tight, pull down on the buckle end of the belt as you pull up on the shoulder belt.

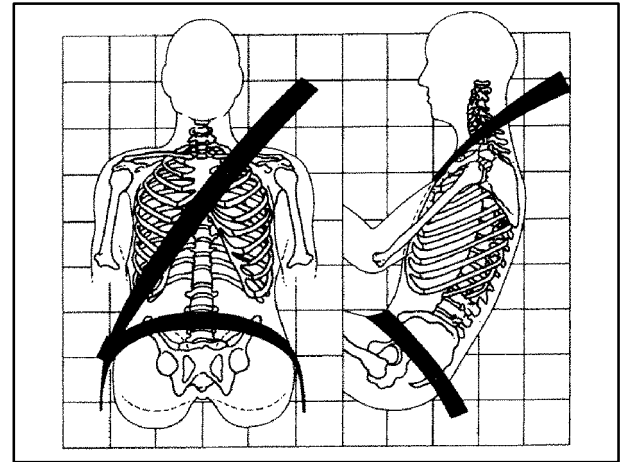

The lap part of the belt should be worn low and snug on the hips, just touching the thighs. In a crash, this applies force to the strong pelvic bones. And you'd be less likely to slide under the lap belt. If you slid under it, the belt would apply force at your abdomen. This could cause serious or even fatal injuries. The shoulder belt should go over the shoulder and across the chest. These parts of the body are best able to take belt restraining forces.

The safety belt locks if there's a sudden stop or crash, or if you pull the belt very quickly out of the retractor.

Shoulder Belt Height Adjuster

Before you begin to drive, move the shoulder belt adjuster to the height that is right for you.



To move it down, press down on the arrow symbol and move the height adjuster to the desired position. You can move the adjuster up just by pushing up on the bottom of the height adjuster. After you move the adjuster to where you want it, try to move it down without pushing in to make sure it has locked into position.

Adjust the height so that the shoulder portion of the belt is centered on your shoulder. The belt should be away from your face and neck, but not falling off your shoulder.

Q: What's wrong with this?

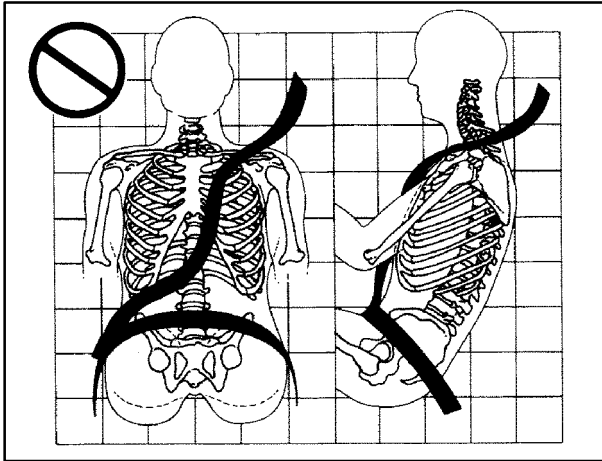

A: The shoulder belt is too loose. It won't give nearly as much protection this way.

⚠ CAUTION:

You can be seriously hurt if your shoulder belt is too loose. In a crash, you would move forward too much, which could increase injury. The shoulder belt should fit against your body.

Q: What's wrong with this?

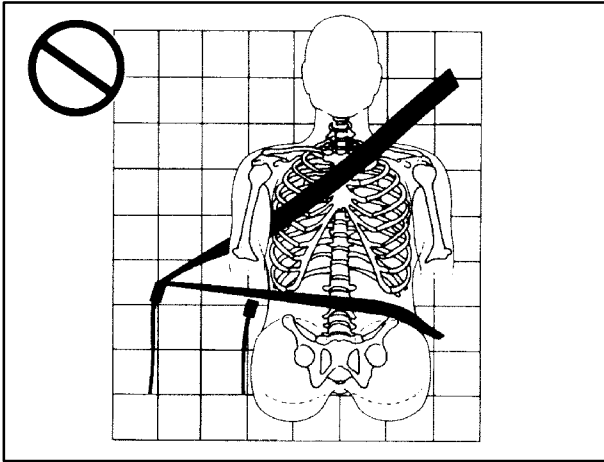

A: The belt is buckled in the wrong place.

⚠ CAUTION:

You can be seriously injured if your belt is buckled in the wrong place like this. In a crash, the belt would go up over your abdomen. The belt forces would be there, not at the pelvic bones. This could cause serious internal injuries. Always buckle your belt into the buckle nearest you.

Q: What's wrong with this?

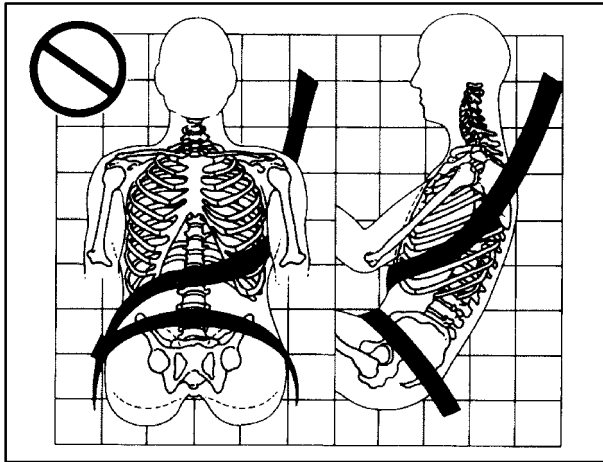

A: The shoulder belt is worn under the arm. It should be worn over the shoulder at all times.

⚠ CAUTION:

You can be seriously injured if you wear the shoulder belt under your arm. In a crash, your body would move too far forward, which would increase the chance of head and neck injury. Also, the belt would apply too much force to the ribs, which aren't as strong as shoulder bones. You could also severely injure internal organs like your liver or spleen.

Q: What's wrong with this?

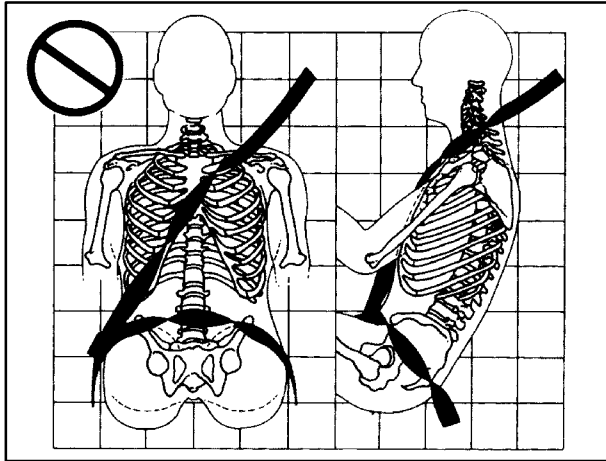

A: The belt is twisted across the body.

⚠ CAUTION:

You can be seriously injured by a twisted belt. In a crash, you wouldn't have the full width of the belt to spread impact forces. If a belt is twisted, make it straight so it can work properly, or ask your dealer to fix it.



To unfasten the belt, just push the button on the buckle. The belt should go back out of the way.

Before you close the door, be sure the belt is out of the way. If you slam the door on it, you can damage both the belt and your vehicle.

Safety Belt Use During Pregnancy

Safety belts work for everyone, including pregnant women. Like all occupants, they are more likely to be seriously injured if they don't wear safety belts.

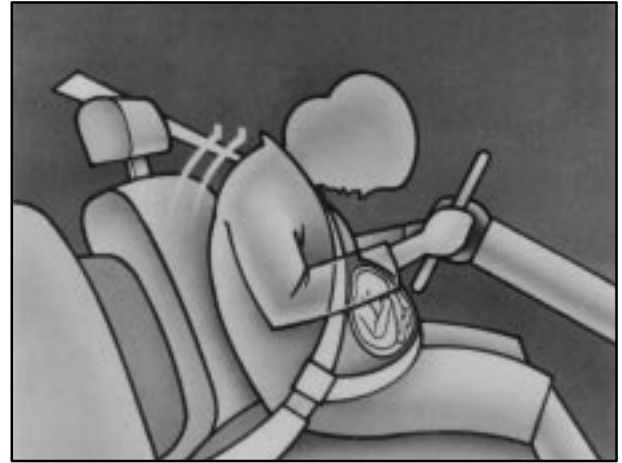

A pregnant woman should wear a lap-shoulder belt, and the lap portion should be worn as low as possible, below the rounding, throughout the pregnancy.

The best way to protect the fetus is to protect the mother. When a safety belt is worn properly, it's more likely that the fetus won't be hurt in a crash. For pregnant women, as for anyone, the key to making safety belts effective is wearing them properly.

Right Front Passenger Position

To learn how to wear the right front passenger's safety belt properly, see "Driver Position" earlier in this section.

The right front passenger's safety belt works the same way as the driver's safety belt -- except for one thing. If you ever pull the shoulder portion of the belt out all the way, you will engage the child restraint locking feature. If this happens, just let the belt go back all the way and start again.

Air Bag Systems

This part explains the frontal and side impact air bag systems.

Your vehicle has air bags -- a "Next Generation" frontal air bag for the driver and another "Next Generation" frontal air bag for the right front passenger. Your vehicle may also have side impact air bags -- a side impact air bag for the driver and another side impact air bag for the right front passenger.

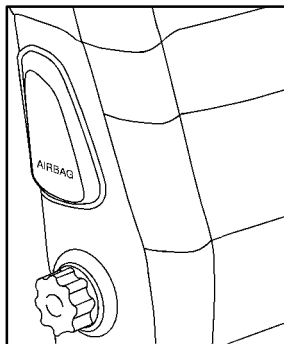

If your vehicle has side impact air bags, it will say AIRBAG on the air bag covering on the side of the driver's and right front passenger's seatback closest to the door.

Next Generation frontal air bags are designed to help reduce the risk of injury from the force of an inflating frontal air bag. But even these air bags must inflate very quickly if they are to do their job and comply with federal regulations.

Here are the most important things to know about the air bag systems:

 **CAUTION:**

You can be severely injured or killed in a crash if you aren't wearing your safety belt -- even if you have air bags. Wearing your safety belt during a crash helps reduce your chance of hitting things inside the vehicle or being ejected from it. Air bags are "supplemental restraints" to the safety belts. All air bags -- even Next Generation air bags -- are designed to work with safety belts but don't replace them.

CAUTION: (Continued)

CAUTION: (Continued)

Next Generation frontal air bags for the driver and right front passenger are designed to work only in moderate to severe crashes where the front of your vehicle hits something. They aren't designed to inflate at all in rollover, rear, side or low-speed frontal crashes. And, for unrestrained occupants, Next Generation frontal air bags may provide less protection in frontal crashes than more forceful air bags have provided in the past. The side impact air bags for the driver and right front passenger are designed to inflate only in moderate to severe crashes where something hits the side of your vehicle. They aren't designed to inflate in frontal, in rollover or in rear crashes. Everyone in your vehicle should wear a safety belt properly -- whether or not there's an air bag for that person.

 **CAUTION:**

Both frontal and side impact air bags inflate with great force, faster than the blink of an eye. If you're too close to an inflating air bag, as you would be if you were leaning forward, it could seriously injure you. This is true even with Next Generation frontal air bags. Safety belts help keep you in position for air bag inflation before and during a crash. Always wear your safety belt, even with Next Generation frontal air bags. The driver should sit as far back as possible while still maintaining control of the vehicle. Front occupants should not lean on or sleep against the door.

 **CAUTION:**

Children who are up against, or very close to, any air bag when it inflates can be seriously injured or killed. This is true even though your vehicle has Next Generation frontal air bags. Air bags plus lap-shoulder belts offer the best protection for adults, but not for young children and infants. Neither the vehicle's safety belt system nor its air bag system is designed for them. Young children and infants need the protection that a child restraint system can provide. Always secure children properly in your vehicle. To read how, see the part of this manual called "Children" and see the caution labels on the sunvisors and the right front passenger's safety belt.

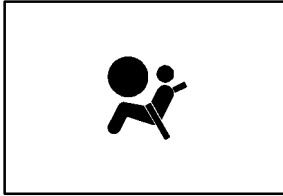

There is an air bag readiness light on the instrument panel, which shows the air bag symbol.

The system checks the air bag electrical system for malfunctions. The light tells you if there is an electrical problem. See “Air Bag Readiness Light” in the Index for more information.

How the Air Bag Systems Work

Where are the air bags?

The driver's frontal air bag is in the middle of the steering wheel.



The right front passenger's frontal air bag is in the instrument panel on the passenger's side.



The driver's side impact air bag is in the side of the driver's seatback closest to the door.

The right front passenger's side impact air bag is in the side of the passenger's seatback closest to the door.



 **CAUTION:**

If something is between an occupant and an air bag, the bag might not inflate properly or it might force the object into that person. The path of an inflating air bag must be kept clear. Don't put anything between an occupant and an air bag, and don't attach or put anything on the steering wheel hub or on or near any other air bag covering and don't let seat covers block the inflation path of a side impact air bag.

When should an air bag inflate?

The driver's and right front passenger's frontal air bags are designed to inflate in moderate to severe frontal or near-frontal crashes. The frontal air bags are designed to inflate only if the impact speed is above the system's designed "threshold level." If your vehicle goes straight into a wall that doesn't move or deform, the threshold level is about 9 to 15 mph (14 to 24 km/h). The threshold level can vary, however, with specific vehicle design, so that it can be somewhat above or below this

range. If your vehicle strikes something that will move or deform, such as a parked car, the threshold level will be higher. The driver's and right front passenger's frontal air bags are not designed to inflate in rollovers, side impacts, or rear impacts, because inflation would not help the occupant.

The driver's and right front passenger's side impact air bags are designed to inflate in moderate to severe side crashes involving a front door. A side impact air bag will inflate if the crash severity is above the system's designed "threshold level." The threshold level can vary with specific vehicle design. Side impact air bags are not designed to inflate in frontal or near-frontal impacts, rollovers or rear impacts, because inflation would not help the occupant. A side impact air bag will only deploy on the side of the vehicle that is struck.

In any particular crash, no one can say whether an air bag should have inflated simply because of the damage to a vehicle or because of what the repair costs were. For frontal air bags, inflation is determined by the angle of the impact and how quickly the vehicle slows down in frontal and near-frontal impacts. For side impact air bags, inflation is determined by the location of the impact and how quickly the side of the vehicle deforms.

What makes an air bag inflate?

In an impact of sufficient severity, the air bag sensing system detects that the vehicle is in a crash. For both frontal and side impact air bags, the sensing system triggers a release of gas from the inflator, which inflates the air bag. The inflator, air bag and related hardware are all part of the air bag modules inside the steering wheel, instrument panel and the side of the front seatbacks closest to the door.

How does an air bag restrain?

In moderate to severe frontal or near frontal collisions, even belted occupants can contact the steering wheel or the instrument panel. In moderate to severe side collisions, even belted occupants can contact the inside of the vehicle. The air bag supplements the protection provided by safety belts. Air bags distribute the force of the impact more evenly over the occupant's upper body, stopping the occupant more gradually. But the frontal air bags would not help you in many types of collisions, including rollovers, rear impacts, and side impacts, primarily because an occupant's motion is not toward the air bag. Side impact air bags would not help you in many types of collisions, including frontal or near

frontal collisions, rollovers, and rear impacts, primarily because an occupant's motion is not toward those air bags. Air bags should never be regarded as anything more than a supplement to safety belts, and then only in moderate to severe frontal or near-frontal collisions for the driver's and right front passenger's frontal air bags, and only in moderate to severe side collisions for the driver's and right front passenger's side impact air bags.

What will you see after an air bag inflates?

After an air bag inflates, it quickly deflates, so quickly that some people may not even realize the air bag inflated. Some components of the air bag module -- the steering wheel hub for the driver's air bag, the instrument panel for the right front passenger's bag, the side of the seatback closest to the door for the driver and right front passenger's side impact air bags -- will be hot for a short time. The parts of the bag that come into contact with you may be warm, but not too hot to touch. There will be some smoke and dust coming from the vents in the deflated air bags. Air bag inflation doesn't prevent the driver from seeing or being able to steer the vehicle, nor does it stop people from leaving the vehicle.

 **CAUTION:**

When an air bag inflates, there is dust in the air. This dust could cause breathing problems for people with a history of asthma or other breathing trouble. To avoid this, everyone in the vehicle should get out as soon as it is safe to do so. If you have breathing problems but can't get out of the vehicle after an air bag inflates, then get fresh air by opening a window or a door.

In many crashes severe enough to inflate an air bag, windshields are broken by vehicle deformation. Additional windshield breakage may also occur from the right front passenger air bag.

- Air bags are designed to inflate only once. After an air bag inflates, you'll need some new parts for your air bag system. If you don't get them, the air bag system won't be there to help protect you in another crash. A new system will include air bag modules and possibly other parts. The service manual for your vehicle covers the need to replace other parts.

- Your vehicle is equipped with a crash sensing and diagnostic module, which records information about the frontal air bag system. The module records information about the readiness of the system, when the system commands air bag inflation and driver's safety belt usage at deployment.
- Let only qualified technicians work on your air bag systems. Improper service can mean that an air bag system won't work properly. See your dealer for service.

NOTICE:

If you damage the covering for the driver's or the right front passenger's air bag, or the air bag covering on the driver's and right front passenger's seatback, the bag may not work properly. You may have to replace the air bag module in the steering wheel, both the air bag module and the instrument panel for the right front passenger's air bag, or both the air bag module and seatback for the driver's and right front passenger's side impact air bag. Do not open or break the air bag coverings.

Servicing Your Air Bag-Equipped Vehicle

Air bags affect how your vehicle should be serviced. There are parts of the air bag systems in several places around your vehicle. Your dealer and the service manual have information about servicing your vehicle and the air bag systems. To purchase a service manual, see “Service and Owner Publications” in the Index.

CAUTION:

For up to 10 seconds after the ignition key is turned off and the battery is disconnected, an air bag can still inflate during improper service. You can be injured if you are close to an air bag when it inflates. Avoid wires wrapped with yellow felt, wires wrapped with yellow tape or yellow connectors. They are probably part of the air bag systems. Be sure to follow proper service procedures, and make sure the person performing work for you is qualified to do so.

The air bag systems do not need regular maintenance.

Safety Belt Pretensioners

Your vehicle has safety belt pretensioners. You’ll find them on the buckle end of the safety belts for the driver and right front passenger. They help the safety belts reduce a person’s forward movement in a moderate to severe crash in which the front of the vehicle hits something.

Pretensioners work only once. If they activate in a crash, you’ll need to get new ones, and probably other new parts for your safety belt system. See “Replacing Restraint System Parts After a Crash” in the Index.

Rear Seat Passengers

It’s very important for rear seat passengers to buckle up! Accident statistics show that unbelted people in the rear seat are hurt more often in crashes than those who are wearing safety belts.

Rear passengers who aren’t safety belted can be thrown out of the vehicle in a crash. And they can strike others in the vehicle who are wearing safety belts.

Rear Seat Passenger Positions

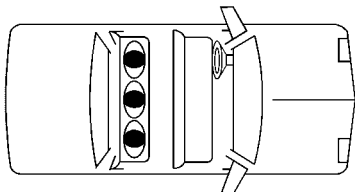

Lap-Shoulder Belt

All three rear seating positions have lap-shoulder belts. Here's how to wear one properly.



1. Pick up the latch plate and pull the belt across you. Don't let it get twisted.

The shoulder belt may lock if you pull the belt across you very quickly. If this happens, let the belt go back slightly to unlock it. Then pull the belt across you more slowly.

2. Push the latch plate into the buckle until it clicks. Pull up on the latch plate to make sure it is secure.

When the shoulder belt is pulled out all the way, it will lock. If it does, let it go back all the way and start again. If the belt is not long enough, see “Safety Belt Extender” at the end of this section. Make sure the release button on the buckle is positioned so you would be able to unbuckle the safety belt quickly if you ever had to.



3. To make the lap part tight, pull down on the buckle end of the belt as you pull up on the shoulder part.

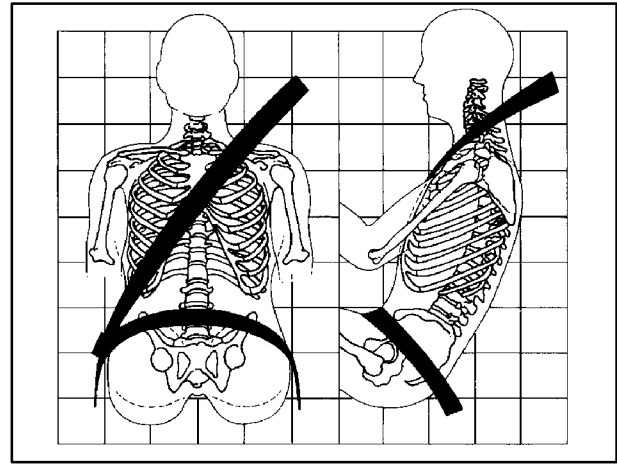

The lap part of the belt should be worn low and snug on the hips, just touching the thighs. In a crash, this applies force to the strong pelvic bones. And you'd be less likely to slide under the lap belt. If you slid under it, the belt would apply force at your abdomen. This could cause serious or even fatal injuries. The shoulder belt should go over the shoulder and across the chest. These parts of the body are best able to take belt restraining forces.

The safety belt locks if there's a sudden stop or a crash, or if you pull the belt very quickly out of the retractor.

Each position next to the windows has a shoulder belt height adjuster. Move the shoulder belt adjuster to the height that is right for you.



To move it down, press the arrow symbol and move the height adjuster to the desired position. You can move the height adjuster up just by pushing up on the bottom of the height adjuster. After you move the adjuster to where you want it, try to move it down without pushing in to make sure it has locked into position.

Adjust the height so that the shoulder portion of the belt is centered on your shoulder. The belt should be away from your face and neck, but not falling off your shoulder.

⚠ CAUTION:

You can be seriously hurt if your shoulder belt is too loose. In a crash, you would move forward too much, which could increase injury. The shoulder belt should fit against your body.



To unlatch the belt, just push the button on the buckle.

Children

Everyone in a vehicle needs protection! That includes infants and all children smaller than adult size. Neither the distance traveled nor the age and size of the traveler changes the need, for everyone, to use safety restraints. In fact, the law in every state in the United States and in every Canadian province says children up to some age must be restrained while in a vehicle.

Smaller Children and Babies

CAUTION:

Children who are up against, or very close to, any air bag when it inflates can be seriously injured or killed. This is true even though your vehicle has Next Generation frontal air bags. Air bags plus lap-shoulder belts offer the best protection for adults, but not for young children and infants. Neither the vehicle's safety belt system nor its air bag system is designed for them. Young children and infants need the protection that a child restraint system can provide. Always secure children properly in your vehicle.

**CAUTION:**

Smaller children and babies should always be restrained in a child or infant restraint. The instructions for the restraint will say whether it is the right type and size for your child. A very young child's hip bones are so small that a regular belt might not stay low on the hips, as it should. Instead, the belt will likely be over the child's abdomen. In a crash, the belt would apply force right on the child's abdomen, which could cause serious or fatal injuries. So, be sure that any child small enough for one is always properly restrained in a child or infant restraint.

Infants need complete support, including support for the head and neck. This is necessary because an infant's neck is weak and its head weighs so much compared with the rest of its body. In a frontal crash, an infant in a rear-facing restraint settles into the restraint, so the crash forces can be distributed across the strongest part of the infant's body, the back and shoulders. A baby should be secured in an appropriate infant restraint. This is so important that many hospitals today won't release a newborn infant to its parents unless there is an infant restraint available for the baby's first trip in a motor vehicle.

**CAUTION: (Continued)**

at only 25 mph (40 km/h), a 12-lb. (5.5 kg) baby will suddenly become a 240-lb. (110 kg) force on your arms. The baby would be almost impossible to hold.

Secure the baby in an infant restraint.

⚠ CAUTION:

Never hold a baby in your arms while riding in a vehicle. A baby doesn't weigh much -- until a crash. During a crash a baby will become so heavy you can't hold it. For example, in a crash

CAUTION: (Continued)



Child Restraints

Every time infants and young children ride in vehicles, they should have protection provided by appropriate restraints.

Q: What are the different types of add-on child restraints?

A: Add-on child restraints are available in four basic types. When selecting a child restraint, take into consideration not only the child's weight and size, but also whether or not the restraint will be compatible with the motor vehicle in which it will be used.

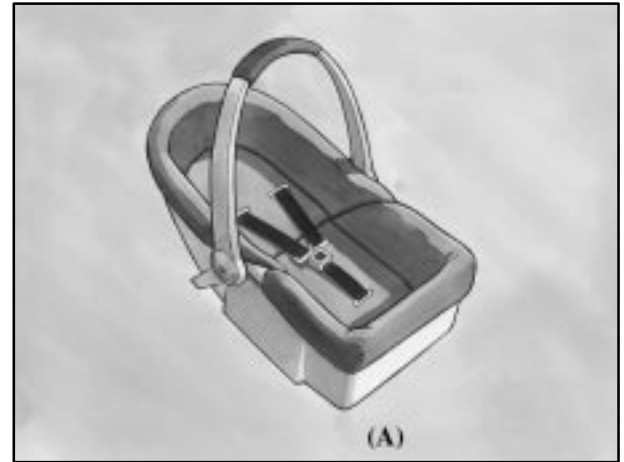

An infant car bed (A) is a special bed made for use in a motor vehicle. It's an infant restraint system designed to restrain or position a child on a continuous flat surface. With an infant car bed, make sure that the infant's head rests toward the center of the vehicle.

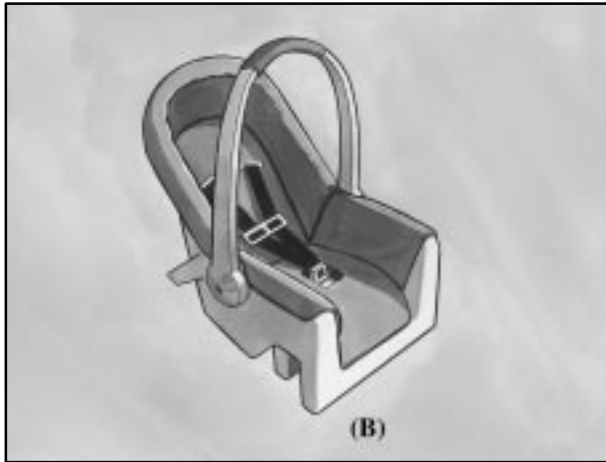

A rear-facing infant restraint (B) positions an infant to face the rear of the vehicle. Rear-facing infant restraints are designed for infants of up to about 20 lbs. (9 kg) and about one year of age. This type of restraint faces the rear so that the infant's head, neck and body can have the support they need in a frontal crash. Some infant seats come in two parts -- the base stays secured in the vehicle and the seat part is removable.



A forward-facing child restraint (C-E) positions a child upright to face forward in the vehicle. These forward-facing restraints are designed to help protect children who are from 20 to 40 lbs. (9 to 18 kg) and about 26 to 40 inches (66 to 102 cm) in height, or up to around four years of age. One type, a convertible restraint, is designed to be used either as a rear-facing infant seat or a forward-facing child seat.

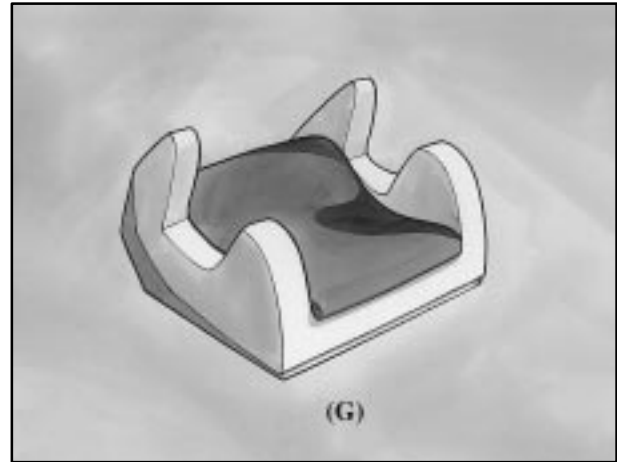
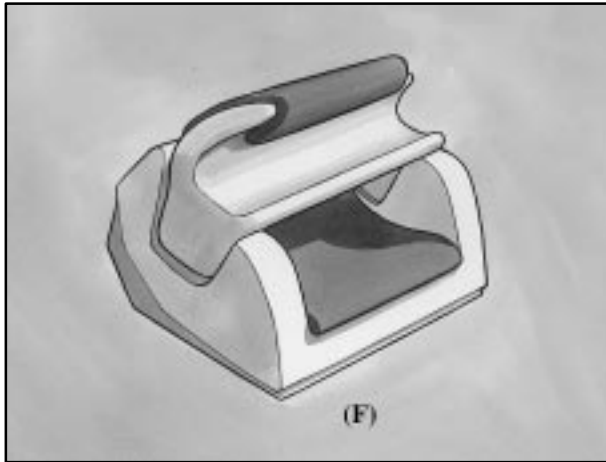

A booster seat (F, G) is designed for children who are about 40 to 60 lbs., or even up to 80 lbs. (18 to 27 kg, or even up to 36 kg), and about four to eight years of age. A booster seat is designed to improve the fit of the vehicle's safety belt system. Booster seats with shields use lap-only belts; however, booster seats without shields use lap-shoulder belts. Booster seats can also help a child to see out the window.

When choosing a child restraint, be sure the child restraint is designed to be used in a vehicle. If it is, it will have a label saying that it meets federal motor vehicle safety standards.

Then follow the instructions for the restraint. You may find these instructions on the restraint itself or in a booklet, or both. These restraints use the belt system in your vehicle, but the child also has to be secured within the restraint to help reduce the chance of personal injury. The instructions that come with the infant or child restraint will show you how to do that. Both the owner's manual and the child restraint instructions are important, so if either one of these is not available, obtain a replacement copy from the manufacturer.

Where to Put the Restraint

Accident statistics show that children are safer if they are restrained in the rear rather than the front seat. We at General Motors therefore recommend that you put your child restraint in the rear seat. *Never* put a rear-facing child restraint in the front passenger seat. Here's why:

CAUTION:

A child in a rear-facing child restraint can be seriously injured or killed if the right front passenger's air bag inflates, even though your vehicle has Next Generation frontal air bags. This is because the back of the rear-facing child restraint would be very close to the inflating air bag. Always secure a rear-facing child restraint in a rear seat.

You may secure a forward-facing child restraint in the right front seat, but before you do, always move the front passenger seat as far back as it will go. It's better to secure the child restraint in a rear seat.

Wherever you install it, be sure to secure the child restraint properly.

Keep in mind that an unsecured child restraint can move around in a collision or sudden stop and injure people in the vehicle. Be sure to properly secure any child restraint in your vehicle -- even when no child is in it.

Top Strap

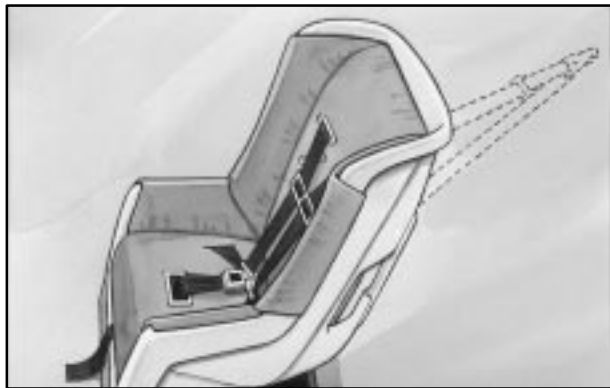

Canadian law requires that forward-facing child restraints have a top strap, and that the strap be anchored.

If your child restraint has a top strap, it should be anchored. If you need to have an anchor installed, your dealer can obtain a kit with anchor hardware and installation instructions specifically designed for this vehicle. The dealer can then install the anchor for you. This work will be done for you free of charge. Or, you may install the anchor yourself using the instructions provided in the kit.

Securing a Child Restraint in a Rear Seat Position

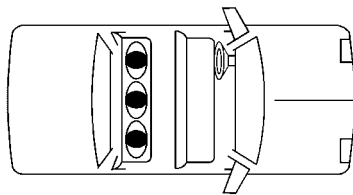

You'll be using the lap-shoulder belt. See the earlier part about the top strap if the child restraint has one. Be sure to follow the instructions that came with the child restraint. Secure the child in the child restraint when and as the instructions say.

1. Put the restraint on the seat.
2. Pick up the latch plate, and run the lap and shoulder portions of the vehicle's safety belt through or around the restraint. The child restraint instructions will show you how.

If the shoulder belt goes in front of the child's face or neck, put it behind the child restraint.

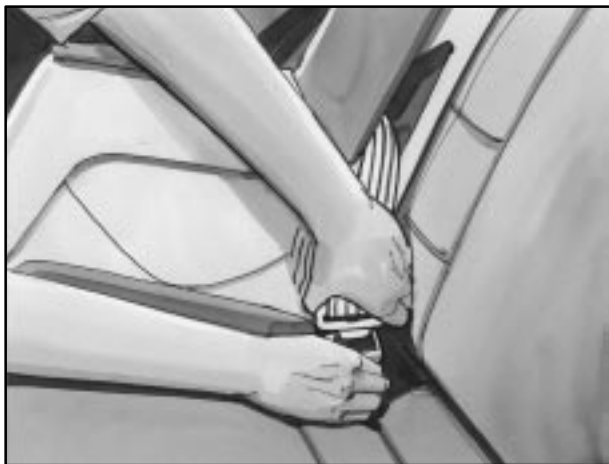

3. Buckle the belt. Make sure the release button is positioned so you would be able to unbuckle the safety belt quickly if you ever had to.



4. Pull the rest of the shoulder belt all the way out of the retractor to set the lock.



5. To tighten the belt, feed the shoulder belt back into the retractor while you push down on the child restraint. If you're using a forward-facing child restraint, you may find it helpful to use your knee to push down on the child restraint as you tighten the belt.

6. Push and pull the child restraint in different directions to be sure it is secure.

To remove the child restraint, just unbuckle the vehicle's safety belt and let it go back all the way. The safety belt will move freely again and be ready to work for an adult or larger child passenger.

Securing a Child Restraint in the Right Front Seat Position

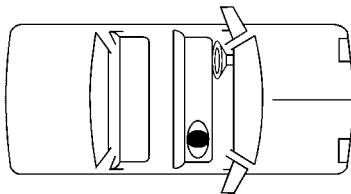

Your vehicle has a right front passenger air bag. *Never* put a rear-facing child restraint in this seat. Here's why:

⚠ CAUTION:

A child in a rear-facing child restraint can be seriously injured or killed if the right front passenger's air bag inflates, even though your vehicle has Next Generation frontal air bags. This is because the back of the rear-facing child restraint would be very close to the inflating air bag. Always secure a rear-facing child restraint in the rear seat.

Although a rear seat is a safer place, you can secure a forward-facing child restraint in the right front seat.

You'll be using the lap-shoulder belt. See the earlier part about the top strap if the child restraint has one. Be sure to follow the instructions that came with the child restraint. Secure the child in the child restraint when and as the instructions say.

1. Because your vehicle has a right front passenger air bag, always move the seat as far back as it will go before securing a forward-facing child restraint. (See "Seats" in the Index.)
2. Put the restraint on the seat.

3. Pick up the latch plate, and run the lap and shoulder portions of the vehicle's safety belt through or around the restraint. The child restraint instructions will show you how.

If the shoulder belt goes in front of the child's face or neck, put it behind the child restraint.



4. Buckle the belt. Make sure the release button is positioned so you would be able to unbuckle the safety belt quickly if you ever had to.



5. Pull the rest of the shoulder belt all the way out of the retractor to set the lock.



6. To tighten the belt, feed the shoulder belt back into the retractor while you push down on the child restraint. You may find it helpful to use your knee to push down on the child restraint as you tighten the belt.
7. Push and pull the child restraint in different directions to be sure it is secure.

To remove the child restraint, just unbuckle the vehicle's safety belt and let it go back all the way. The safety belt will move freely again and be ready to work for an adult or larger child passenger.

Larger Children



Children who have outgrown child restraints should wear the vehicle's safety belts.

Accident statistics show that children are safer if they are restrained in the rear seat. But they need to use the safety belts properly.

- Children who aren't buckled up can be thrown out in a crash.
- Children who aren't buckled up can strike other people who are.

**⚠ CAUTION:**

Never do this.

Here two children are wearing the same belt. The belt can't properly spread the impact forces. In a crash, the two children can be crushed together and seriously injured. A belt must be used by only one person at a time.

- Q:** What if a child is wearing a lap-shoulder belt, but the child is so small that the shoulder belt is very close to the child's face or neck?
- A:** If the child is sitting in a seat next to a window, move the child toward the center of the vehicle. If the child is sitting in the center rear seat passenger position, move the child toward the safety belt buckle. In either case, be sure that the shoulder belt still is on the child's shoulder, so that in a crash the child's upper body would have the restraint that belts provide.



⚠ CAUTION:

Never do this.

Here a child is sitting in a seat that has a lap-shoulder belt, but the shoulder part is behind the child. If the child wears the belt in this way, in a crash the child might slide under the belt. The belt's force would then be applied right on the child's abdomen. That could cause serious or fatal injuries.

The lap portion of the belt should be worn low and snug on the hips, just touching the child's thighs. This applies belt force to the child's pelvic bones in a crash.

Safety Belt Extender

If the vehicle's safety belt will fasten around you, you should use it.

But if a safety belt isn't long enough to fasten, your dealer will order you an extender. It's free. When you go in to order it, take the heaviest coat you will wear, so the extender will be long enough for you. The extender will be just for you, and just for the seat in your vehicle that you choose. Don't let someone else use it, and use it only for the seat it is made to fit. To wear it, just attach it to the regular safety belt.

Checking Your Restraint Systems

Now and then, make sure the safety belt reminder light and all your belts, buckles, latch plates, retractors and anchorages are working properly. Look for any other loose or damaged safety belt system parts. If you see anything that might keep a safety belt system from doing its job, have it repaired.

Torn or frayed safety belts may not protect you in a crash. They can rip apart under impact forces. If a belt is torn or frayed, get a new one right away.

Also look for any opened or broken air bag covers, and have them repaired or replaced. (The air bag system does not need regular maintenance.)

Replacing Restraint System Parts After a Crash

If you've had a crash, do you need new belts?

After a very minor collision, nothing may be necessary. But if the belts were stretched, as they would be if worn during a more severe crash, then you need new belts.

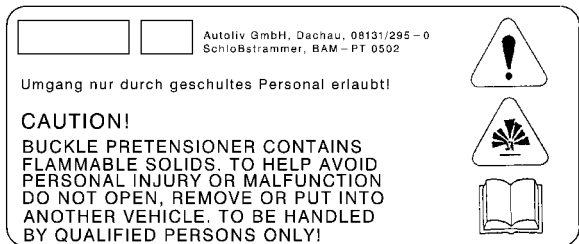

If you ever see a yellow label on the driver's or the right front passenger's safety belt buckle, that means to replace the buckle assembly. Be sure to do so. Then the new buckle assembly will be there to help protect you in a collision.

If belts are cut or damaged, replace them. Collision damage also may mean you will need to have safety belt or seat parts repaired or replaced. New parts and repairs may be necessary even if the belt wasn't being used at the time of the collision.

If an air bag inflates, you'll need to replace air bag system parts. See the part on the air bag system earlier in this section.



NOTES



Section 2 Features and Controls

Here you can learn about the many standard and optional features on your vehicle, and information on starting, shifting and braking. Also explained are the instrument panel and the warning systems that tell you if everything is working properly -- and what to do if you have a problem.

2-2	Keys	2-30	Parking Over Things that Burn
2-4	Door Locks	2-30	Engine Exhaust
2-7	Remote Keyless Entry System (RKE)	2-31	Running Your Engine While You're Parked
2-11	Trunk	2-32	Windows
2-12	Theft	2-33	Horn
2-13	Theft-Deterrent System	2-34	Tilt Wheel
2-15	Immobilizer	2-34	Turn Signal/Multifunction Lever
2-16	New Vehicle "Break-In"	2-40	Exterior Lamps
2-16	Ignition Positions	2-46	Interior Lamps
2-18	Starting Your Engine	2-47	Mirrors
2-19	Engine Coolant Heater (If Equipped)	2-49	Storage Compartments
2-21	Automatic Transmission Operation	2-52	Sunroof (Option)
2-25	Parking Brake	2-56	Universal Transmitter (If Equipped)
2-26	Shifting Into PARK (P)	2-60	Instrument Panel
2-28	Shifting Out of PARK (P)	2-63	Warning Lights, Gages and Indicators

Keys

CAUTION:

Leaving children in a vehicle with the ignition key is dangerous for many reasons. A child or others could be badly injured or even killed.

They could operate power windows or other controls or even make the vehicle move. Don't leave the keys in a vehicle with children.





One key is used for the ignition, the doors and all other locks. (Note that there is no lock cylinder for the trunk or the passenger's door.)

Your vehicle comes with a spare key. This key does not have an immobilizer pellet in it, however, it will still unlock your vehicle's doors. Because of the key's flat shape, it can be stored in your wallet.

If you've lost your keys or need to have a new one made, you will have to contact your dealer for the correct key code.

NOTICE:

Your vehicle has a number of new features that can help prevent theft. You can have a lot of trouble getting into your vehicle if you ever lock your keys inside and you may have to damage your vehicle to get in. Be sure you have extra keys.

Door Locks

CAUTION:

Unlocked doors can be dangerous.

Passengers -- especially children -- can easily open the doors and fall out. When a door is locked, the inside handle won't open it.

Outsiders can easily enter through an unlocked door when you slow down or stop your vehicle.

This may not be so obvious: You increase the chance of being thrown out of the vehicle in a crash if the doors aren't locked. Wear safety belts properly, lock your doors, and you will be far better off whenever you drive your vehicle.

There are several ways to lock and unlock your vehicle. From the outside, use your key or the remote keyless entry transmitter. This will avoid setting off the optional theft-deterrent alarm.



From inside your vehicle, slide the lock lever down to lock the door. To unlock the door, slide the lock lever up.

Central Door Unlocking System

When unlocking the driver's door from the outside, you can also unlock the other doors by holding the key in a turned position for several seconds (turn the key counterclockwise). Pressing the unlock button on the remote keyless entry transmitter twice in a row will also open the other doors.

Power Door Locks



Push the side of the door lock switch with the light in it to lock all the doors and push the other side of the door lock switch to unlock all doors.

Automatic Door Locks

Close the doors and turn on the ignition. Every time you move the shift lever out of PARK (P), all of the doors will lock. The doors will unlock every time you stop the vehicle and move the shift lever into PARK (P). If someone needs to get out while your vehicle is not in PARK (P), have that person use the manual or power lock. When the door is closed again, it will not lock automatically. Use the manual or power lock to lock the door again.

Programmable Automatic Door Locks

Each remote keyless entry transmitter supplied with your vehicle can be programmed to suit each driver's door lock preference. The two remote keyless entry transmitters are identified on the back with either a "1" or a "2", which allows either driver to program their own door locks.

The automatic door locks can be programmed (using the remote keyless entry transmitter) for various lock and unlock options.

With the ignition on, the transmission in PARK (P) and the brake pedal pressed down, you are now ready to begin programming.

To program:

All doors do not unlock when shifting into

PARK (P): Press the unlock button on the remote keyless entry transmitter four times. Each press should be held for about one second with less than five seconds in between each press.

All doors unlock when shifting into PARK (P): Press the unlock button on the remote keyless entry transmitter four times. Each press should be held for about one second with less than five seconds in between each press.

Note: The unlock button will toggle between the above two settings.

All doors do not lock when shifting out of

PARK (P): Press the lock button on the remote keyless entry transmitter four times. Each press should be held for about one second with less than five seconds in between each press.

All doors lock when shifting out of PARK (P): Press the lock button on the remote keyless entry four times. Each press should be held for about one second with less than five seconds in between each press.

Note: The lock button will toggle between the above two settings.

Rear Door Security Lock



Your vehicle is equipped with rear door security locks that help prevent passengers from opening the rear door of your vehicle from the inside. The lock is located on the rear edge of each rear door.

To use this lock:

1. Move the lever on the door all the way down into the ENGAGED position.
2. Close the door.
3. Do the same thing to the other rear door lock.

The rear doors of your vehicle cannot be opened from the inside when this feature is in use.

When you want to open a rear door when the security lock is on:

1. Unlock the door from the inside.
2. Then open the door from the outside.

To cancel the rear door lock:

1. Unlock the door from the inside and open the door from the outside.
2. Move the lever all the way up.
3. Do the same for the other rear door.

The rear door locks will now work normally.

Anti-Lockout Feature

Leaving your key in any ignition position with any door open will prevent locking of the doors with either the power door lock switches or the remote keyless entry transmitter. It is always recommended that you remove the ignition key when locking your vehicle.

Note: The anti-lockout feature can be overridden by holding the power door lock switch for three seconds or longer.

Leaving Your Vehicle

If you are leaving your vehicle, open the door, set the locks from the inside, get out and close the door.

Remote Keyless Entry System (RKE)



If your vehicle has this option, you can lock and unlock your doors, or unlock your trunk from about 3 feet (1 m) up to 30 feet (9 m) away using the remote keyless entry transmitter supplied with your vehicle.

Your remote keyless entry transmitter operates on a radio frequency subject to Federal Communications Commission (FCC) Rules and with Industry Canada.

This device complies with Part 15 of the FCC Rules. Operation is subject to the following two conditions: (1) this device may not cause harmful interference, and (2) this device must accept any interference received, including interference that may cause undesired operation.

This device complies with RSS-210 of Industry Canada. Operation is subject to the following two conditions: (1) this device may not cause interference, and (2) this device must accept any interference received, including interference that may cause undesired operation of the device.

Changes or modifications to this system by other than an authorized service facility could void authorization to use this equipment.

The range of this system is about 10 feet (3 m). At times you may notice a decrease in range. This is normal for any remote keyless entry transmitter. If the transmitter does not work or if you have to stand closer to your vehicle for the transmitter to work, try this:

- Check to determine if battery replacement or resynchronization is necessary. See the instructions that follow.
- Check the distance. You may be too far from your vehicle. You may need to stand closer during rainy or snowy weather.
- Check the location. Other vehicles or objects may be blocking the signal. Take a few steps to the left or right, hold the transmitter higher, and try again.
- If you're still having trouble, see your dealer or a qualified technician for service.

Operation

 When you press this symbol to unlock the driver's door, the parking lamps on your vehicle will blink twice. The parking lamps and headlamps will remain on for about 20 seconds. Pressing this button again within five seconds will unlock the other doors. Pressing this button will also disarm the optional theft-deterrent system and turn on the interior lamps (for approximately 20 seconds).

 When you press this symbol to lock the doors (including the fuel door), the parking lamps will blink once. This also arms the optional theft-deterrent system.

 Press this symbol to open the trunk.

 Press this button to unlock the fuel door.

Matching Transmitter(s) To Your Vehicle

Each remote keyless entry transmitter is coded to prevent another transmitter from unlocking your vehicle. If a transmitter is lost or stolen, a replacement can be purchased through your dealer. Once your dealer has coded the new transmitter, the lost transmitter will not unlock your vehicle. Your vehicle may be equipped with either a two or four fob capability and is only able to have the same number of transmitters matched to it. Since all vehicles come with only two fobs, you need to check with your dealer to see which system you have.

Battery Replacement

Under normal use, the battery in your remote keyless entry transmitter should last about four years.

You can tell the battery is weak if the transmitter won't work at the normal range in any location. If you have to get close to your vehicle before the transmitter works, it's probably time to change the battery.

NOTICE:

When replacing the battery, use care not to touch any of the circuitry. Static from your body transferred to these surfaces may damage the transmitter.



1. Use a coin to pry open the transmitter.



2. Remove the battery and replace it with a CR2032 battery. Using the wrong size battery can damage the transmitter. Make sure the battery is positioned with the “plus” (+) facing down.
3. Align the internal pieces of the transmitter, including the cover. Snap together to reinstall.

Resynchronization

Pressing the transmitter buttons numerous times (approximately 250 times) out of the vehicle's operating range may cause the transmitter not to work. Replacing the battery and pressing the transmitter buttons 10 or more times out of range will also cause the transmitter not to work.

For vehicles with two transmitters:

To resynchronize the transmitter, you must be within the vehicle's operating range. Press and hold the trunk button and within one second press the lock button.

For vehicles with four transmitters:

To resynchronize the transmitter, you must be within the vehicle's operating range. Press and hold the lock and unlock buttons for approximately 5 to 10 seconds.

See your dealer for service if your transmitter still doesn't work properly.

Trunk

CAUTION:

It can be dangerous to drive with the trunk lid open because carbon monoxide (CO) gas can come into your vehicle. You can't see or smell CO. It can cause unconsciousness and even death.

If you must drive with the trunk lid open or if electrical wiring or other cable connections must pass through the seal between the body and the trunk lid:

- Make sure all other windows are shut.
 - Turn the fan on your heating or cooling system to its highest speed with the setting on AUTO and the temperature between 65°F (18°C) and 85°F (29°C). That will force outside air into your vehicle. See “Comfort Controls” in the Index.
 - If you have air outlets on or under the instrument panel, open them all the way.
- See “Engine Exhaust” in the Index.

Trunk Release



To use this feature, your vehicle must be in PARK (P). Press the trunk release button located on the center console next to the radio to open the trunk.

You can also press the trunk button on the remote keyless entry transmitter to access the trunk compartment. Your vehicle doesn't have a trunk key lock cylinder.



If your vehicle loses power temporarily, you can manually open the trunk using the trunk release handle. The handle is located on the underside of the trunk lid on the driver's side and can be accessed through the fold-down rear seats.

Fold down the driver's side rear seat and reach through to the trunk compartment to find the release handle. Pulling the handle opens the trunk. For more information on how to fold the rear seats, see "Folding the Rear Seat" in the Index.

Theft

Vehicle theft is big business, especially in some cities. Although your vehicle has a number of theft-deterrent features, we know that nothing we put on it can make it impossible to steal. However, there are ways you can help.

Key in the Ignition

If you leave your vehicle with the keys inside, it's an easy target for joy riders or professional thieves -- so don't do it.

When you park your vehicle and open the driver's door, you'll hear a tone reminding you to remove your key from the ignition and take it with you. Always do this. Your steering wheel will be locked, and so will your ignition and transmission. And remember to lock the doors.

Parking at Night

Park in a lighted spot, close all windows and lock your vehicle. Remember to keep your valuables out of sight. Put them in a storage area, or take them with you.

Parking Lots

If you park in a lot where someone will be watching your vehicle, it's best to lock it up and take your keys. But what if you have to leave your key?

- If possible, park in a busy, well lit area.
- Put your valuables in a storage area, like your trunk or glove box. Be sure to close and lock the storage area.
- Close all windows.
- Move the trunk release lockout switch to LK (lock).
- Lock the glove box.
- Lock all the doors except the driver's.
- Then take the door key and remote keyless entry transmitter with you.

Theft-Deterrent System



If the ignition is off and any door is open, the SECURITY light will flash to remind you to activate the system.

1. Open the door.
2. Lock the door using the power door lock or the remote keyless entry transmitter. The SECURITY light should come on and stay on.
3. Close all the doors. The SECURITY light should go off within approximately 30 seconds.

The horn will sound and the headlamps will flash for several minutes when the door or trunk is opened without the key or remote keyless entry transmitter. The horn also sounds if the locks are damaged.

Remember, the theft-deterrent system won't activate if you lock the doors with a key or use the manual door lock. It activates only if you use a power door lock switch or the remote keyless entry transmitter.

To avoid activating the alarm by accident:

- The vehicle should be locked with the key *after* the doors are closed if you don't want to activate the theft-deterrent system.
- Always unlock a door with a key or use the remote keyless entry transmitter. (Pressing the unlock button on the remote keyless entry transmitter disables the theft-deterrent system.) Unlocking a door any other way will activate the alarm. Cycling the ignition without disarming the theft-deterrent system will also activate the alarm.

If you activate the alarm by accident, unlock the driver's door with your key. You can also turn off the alarm by using the remote keyless entry transmitter. The alarm won't stop if you try to unlock a door in any other way.

Testing the Alarm

1. From inside the vehicle, roll down the window, then get out of the vehicle, keeping the door open.
2. From outside the vehicle, with the door open, lock the vehicle using the power door lock or the remote keyless entry transmitter and close the door. Wait 30 seconds until the SECURITY light stops flashing.
3. Reach in and unlock the door using the manual lock and open the door. The horn will sound and the headlamps will flash.

If the alarm does not sound when it should, check to see if the horn works. The horn fuse may be blown. To replace the fuse, see "Fuses and Circuit Breakers" in the Index. If the fuse does not need to be replaced, you may need to have your vehicle serviced.

To reduce the possibility of theft, always activate the optional theft-deterrent system when leaving your vehicle.

Immobilizer



Your vehicle is equipped with a passive theft-deterrent system.

This device complies with Part 15 of the FCC Rules. Operation is subject to the following two conditions: (1) this device may not cause harmful interference, and (2) this device must accept any interference received, including interference that may cause undesired operation.

This device complies with RSS-210 of Industry Canada. Operation is subject to the following two conditions: (1) this device may not cause interference, and (2) this device must accept any interference received, including interference that may cause undesired operation of the device.

Changes or modifications to this system by other than an authorized service facility could void authorization to use this equipment.

The system works when you turn the key to ON (II). The key uses a transponder that matches an immobilizer control unit in your vehicle. The correct key will start the vehicle.

When the system senses that someone is using the wrong key, it may start but it will not continue to run. If someone tries to start your vehicle again or uses another key during this time, the shutdown will start over again. This discourages someone from randomly trying different keys with different transponders in an attempt to make a match.

If the engine cannot be started, turn the key in the ignition to ON (II). Wait approximately two seconds; then start your vehicle again.

If the engine still won't start, try another key. You may also want to check the fuses (see "Fuses and Circuit Breakers" in the Index). If the engine won't start with the other key, your vehicle needs service. If your vehicle does start, the first key may be faulty. See your dealer.

If you lose or damage a key or you cannot start the engine, see your dealer. If a key is lost, bring all remaining keys to your dealer for re-programming. In an emergency, call the Cadillac Roadside Assistance Center at 1-800-882-1112.

New Vehicle “Break-In”

NOTICE:

Your vehicle doesn't need an elaborate “break-in.” But it will perform better in the long run if you follow these guidelines:

- Don't drive at any one speed -- fast or slow -- for the first 500 miles (805 km). Don't make full-throttle starts.
- Avoid making hard stops for the first 200 miles (322 km) or so. During this time your new brake linings aren't yet broken in. Hard stops with new linings can mean premature wear and earlier replacement. Follow this breaking-in guideline every time you get new brake linings.
- Don't tow a trailer during break-in. See “Towing a Trailer” in the Index for more information.

Ignition Positions

CAUTION:

Leaving children in a vehicle with the ignition key is dangerous for many reasons. A child or others could be badly injured or even killed. They could operate power windows or other controls or even make the vehicle move. Don't leave the keys in the vehicle with children.

NOTICE:

If your key seems stuck in LOCK and you can't turn it, be sure you are using the correct key; if so, is it all the way in? If it is, then turn the steering wheel left and right while you turn the key hard. But turn the key only with your hand. Using a tool to force it could break the key or the ignition switch. If none of this works, then your vehicle needs service.

Keep in mind that you may have to turn the steering wheel as you turn the key in order to turn the ignition switch from LOCK to START -- this is normal. Using extra effort to remove the key from the ignition switch, as compared to other GM vehicles that you may have owned, is also normal.

If your key is stuck in the ignition switch and cannot be turned back to LOCK, your vehicle will need to be repaired. See your dealer for service.

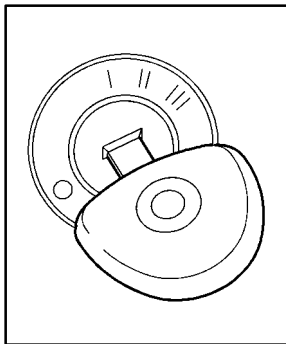

With the key in the ignition switch, you can turn the switch to four different positions.

LOCK (●): Before you put the key in, the ignition will be in LOCK. This is the only position from which you can remove the key. This position locks the ignition, steering wheel and transmission. It's a theft-deterrent feature.

OFF (I): This position lets you turn off the engine but still turn the steering wheel. It doesn't lock the steering wheel like LOCK. Use OFF if you must have your vehicle in motion while the engine is off (for example, if your vehicle is being pushed).

ON (II): The ignition is on in this position. ON is used for driving your vehicle.

START (III): This position starts the engine.

To lock the steering column, remove the key while in LOCK. Turn the steering wheel until you hear a click.

Retained Accessory Power (RAP)

The radio and the optional cellular phone are the only accessories on your vehicle that may be used for up to 10 minutes after the ignition is turned to OFF or until a door is opened.

Power to the door locks is available at all times. Power to the fuel door and trunk release will be available for 15 minutes after the ignition is turned to OFF. The power window controls and the sunroof (optional) controls are active until a door is opened -- there is no time limit as long as the doors remain closed.

Starting Your Engine

Move your shift lever to PARK (P) or NEUTRAL (N). Your engine won't start in any other position -- that's a safety feature. To restart when you're already moving, use NEUTRAL (N) only.

NOTICE:

Don't try to shift to PARK (P) if your vehicle is moving. If you do, you could damage the transmission. Shift to PARK (P) only when your vehicle is stopped.

1. Without pushing the accelerator pedal, turn your ignition key to START. When the engine starts, let go of the key. The idle speed will go down as your engine gets warm.

NOTICE:

Holding your key in START for longer than 15 seconds at a time will cause your battery to be drained much sooner. And the excessive heat can damage your starter motor. Wait about 15 seconds between each try to help avoid draining your battery or damaging your starter.

2. If it doesn't start right away, hold your key in START for about three seconds at a time until your engine starts. Wait about 15 seconds between each try to help avoid draining your battery or damaging your starter.

- If your engine still won't start (or starts but then stops), it could be flooded with too much gasoline. Try pushing your accelerator pedal all the way to the floor and holding it there as you hold the key in START for about three seconds. If the Catera starts briefly but then stops again, do the same thing.

NOTICE:

Your engine is designed to work with the electronics in your vehicle. If you add electrical parts or accessories, you could change the way the engine operates. Before adding electrical equipment, check with your dealer. If you don't, your engine might not perform properly.

If you ever have to have your vehicle towed, see the part of this manual that tells how to do it without damaging your vehicle. See "Towing Your Vehicle" in the Index.

Engine Coolant Heater (If Equipped)

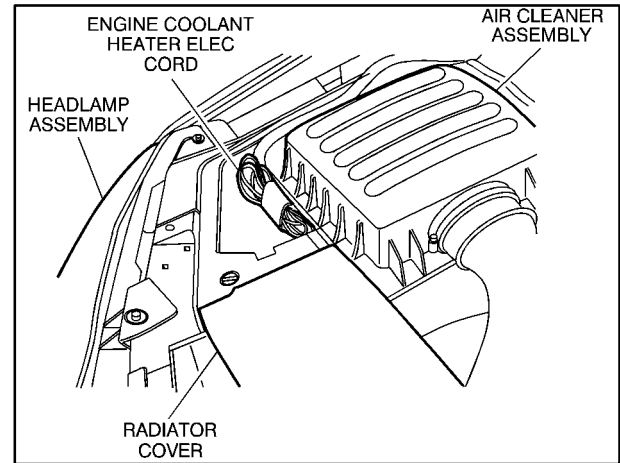

In very cold weather, 0°F (-18°C) or colder, the engine coolant heater can help. You'll get easier starting and better fuel economy during engine warm-up. Usually, the coolant heater should be plugged in a minimum of four hours prior to starting your vehicle.

To Use the Engine Coolant Heater

1. Turn off the engine.
2. Open the hood and unwrap the electrical cord.

The electrical cord for the engine coolant heater is in front of the air cleaner filter and under the headlamp cover, on the passenger's side of the engine.

3. Plug it into a normal, grounded 110-volt AC outlet.

4. Before starting the engine, be sure to unplug and store the cord as it was before to keep it away from moving engine parts. If you don't, it could be damaged.

How long should you keep the coolant heater plugged in? The answer depends on the outside temperature, the kind of oil you have, and some other things. Instead of trying to list everything here, we ask that you contact your dealer in the area where you'll be parking your vehicle. The dealer can give you the best advice for that particular area.

CAUTION:

Plugging the cord into an ungrounded outlet could cause an electrical shock. Also, the wrong kind of extension cord could overheat and cause a fire. You could be seriously injured. Plug the cord into a properly grounded three-prong 110-volt AC outlet. If the cord won't reach, use a heavy-duty three-prong extension cord rated for at least 15 amps.

Automatic Transmission Operation



There are several different positions for the shift lever.

PARK (P): This position locks the transmission drive shaft. It's the best position to use when you start the engine because your vehicle can't move easily.

CAUTION:

It is dangerous to get out of your vehicle if the shift lever is not fully in PARK (P) with the parking brake firmly set. Your vehicle can roll. Don't leave your vehicle when the engine is running unless you have to. If you have left the engine running, the vehicle can move suddenly. You or others could be injured. To be sure your vehicle won't move, even when you're on fairly level ground, always set your parking brake and move the shift lever to PARK (P).

See "Shifting Into PARK (P)" in the Index. If you're pulling a trailer, see "Towing a Trailer" in the Index.

Ensure the shift lever is fully in PARK (P) before starting the engine.

Your vehicle has a Brake-Transmission Shift Interlock (BTSI). You have to fully apply the regular brakes *before* you can shift from PARK (P) when the ignition key is in ON. If you cannot shift out of PARK (P), ease pressure on the shift lever -- push the shift lever all the way into PARK (P) as you maintain brake application. Then move the shift lever into the gear you wish. See “Shifting Out of PARK (P)” in this section.

REVERSE (R): Use this gear to back up.

To rock your vehicle back and forth to get out of snow, ice or sand without damaging the transmission, see “Stuck: In Sand, Mud, Ice or Snow” in the Index.

NEUTRAL (N): The engine doesn’t connect with the wheels when driving in NEUTRAL (N). Use NEUTRAL (N) to restart your vehicle when you’re already moving or when your vehicle is being towed.

 **CAUTION:**

Shifting out of PARK (P) or NEUTRAL (N) while your engine is “racing” (running at high speed) is dangerous. Unless your foot is firmly on the brake pedal, your vehicle could move very rapidly. You could lose control and hit people or objects. Don’t shift out of PARK (P) or NEUTRAL (N) while your engine is racing.

NOTICE:

Damage to the transmission caused by shifting out of PARK (P) or NEUTRAL (N) with the engine racing isn’t covered by your warranty.

DRIVE (D): Use this for normal driving. If you need more power for passing, and you're:

- Going less than 35 mph (55 km/h), push the accelerator pedal about halfway down.
- Going about 35 mph (55 km/h) or more, push the accelerator all the way down.

The transmission will shift down to the next gear.

THIRD (3): This position is not used for normal driving. It offers more power and lower fuel economy than DRIVE (D).

Here are some times you might choose THIRD (3) instead of DRIVE (D):

- When driving on hilly, winding roads.
- When towing a trailer, so there is less shifting between gears.
- When going down a steep hill.

SECOND (2): Driving in this position gives you more power than driving in THIRD (3). Use it on hills. It can help control your speed as you go down steep mountain roads, but then you would also want to use the brakes off and on.

FIRST (1): This position gives you more power (but lower fuel economy) than SECOND (2). You can use it on very steep hills. If the shift lever is put in FIRST (1), the transmission won't shift into first gear until the vehicle is going slowly enough.

NOTICE:

If the rear wheels can't rotate, don't try to drive. This might happen if you were stuck in very deep sand or mud or you were up against a solid object. You could damage the transmission.

Also, if you stop when going uphill, don't hold your vehicle there with only the accelerator pedal. This could overheat and damage the transmission. Use the brakes to hold your vehicle in position on a hill.

Note: When you start your vehicle and the engine temperature is below 86°F (30° C), upshifting of the transmission will be delayed for about one minute. This is normal. The engine's catalytic converter is warming up during this time.

Upshifting and downshifting of the transmission is automatically modified to prevent undesired shifting when your vehicle is towing a trailer or when you are driving in hilly or mountainous terrain. This is also normal.

Sport Mode Button



For a firmer shift and increased performance, you may choose the sport mode. This button lets you change from a normal driving mode to a sport driving mode. It is located on the shift lever handle.

Press the “S” button once to select the sport feature. Press it again to return to the normal driving mode.

When you start the engine, your vehicle will be in normal mode. For general driving conditions, use the normal mode. It will remain in normal unless you select the sport feature.

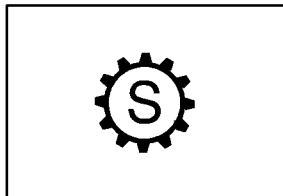

A telltale light on the instrument panel will come on when the sport mode is selected.

If this light begins flashing while you are driving, there may be a fault in the automatic transmission. Have your vehicle serviced.

Third-Gear Start



Press this button to provide more traction when you are starting on ice or other slippery surfaces. It only operates when the shift lever is in DRIVE (D). The button is located next to the shift lever on the console.

The transmission will be in THIRD (3) when the vehicle begins to move. After starting in THIRD (3), the vehicle will upshift normally.

This feature is for improved traction only when the road surface is slippery and is not intended for continuous use or when the vehicle is stuck in sand, mud, ice, snow or gravel. Drive as usual for normal road conditions.

This feature automatically turns off when any of the following conditions occur:

- When the ignition is turned off.
- If the shift lever is placed in PARK (P), THIRD (3), SECOND (2), or FIRST (1).
- If you press and hold the accelerator pedal past its resistance point for more than two seconds.
- When speed falls below 25 mph (40 km/h).
- Once the vehicle reaches 67 mph (108 km/h).

To turn this feature off, press the button again.

Whenever you start your vehicle, the transmission is in the normal mode.

Parking Brake



To set the parking brake, hold the regular brake pedal down with your foot and pull up on the parking brake lever. If the ignition is on, the brake system warning light will come on.

If you start to drive with the parking brake set, the BRAKE warning light stays on. See “Brake System Warning Light” in the Index for more information.

To release the parking brake, hold the brake pedal down with your foot and pull the parking brake lever up until you can press the end release button. Hold the release button in as you move the brake lever all the way down.

NOTICE:

Driving with the parking brake on can cause the rear brakes to overheat. You may have to replace them, and you could also damage other parts of your vehicle.

If you are towing a trailer and are parking on a hill, see “Towing a Trailer” in the Index. This section shows what to do first to keep the trailer from moving.

Shifting Into PARK (P)

CAUTION:

It can be dangerous to get out of your vehicle if the shift lever is not fully in PARK (P) with the parking brake firmly set. Your vehicle can roll. If you have left the engine running, the vehicle can move suddenly. You or others could be injured. To be sure your vehicle won't move, even when you're on fairly level ground, use the steps that follow. If you're pulling a trailer, see “Towing a Trailer” in the Index.

Console Shift Lever

1. Hold the brake pedal down with your right foot.



2. Move the shift lever into PARK (P) like this:
 - Pull the button on the shift lever handle up and then push the shift lever all the way toward the front of your vehicle into PARK (P). Release the button.
 - With your right foot still holding the brake pedal down, set the parking brake.

3. Turn the ignition key to LOCK.
4. Remove the ignition key and take it with you. If you can leave your vehicle with the key in your hand, your vehicle is in PARK (P).

Leaving Your Vehicle With the Engine Running

CAUTION:

It can be dangerous to leave your vehicle with the engine running. Your vehicle could move suddenly if the shift lever is not fully in PARK (P) with the parking brake firmly set. And, if you leave the vehicle with the engine running, it could overheat and even catch fire. You or others could be injured. Don't leave your vehicle with the engine running unless you have to.

If you have to leave your vehicle with the engine running, be sure your vehicle is in PARK (P) and the parking brake is firmly set before you leave it. After you've moved the shift lever into PARK (P), hold the regular brake pedal down. Then, see if you can move the shift lever away from PARK (P) without pressing the button on the shift lever handle. If you can, it means that the shift lever wasn't fully locked into PARK (P).

Torque Lock

If you are parking on a hill and you don't shift your transmission into PARK (P) properly, the weight of the vehicle may put too much force on the parking pawl in the transmission. You may find it difficult to pull the shift lever out of PARK (P). This is called "torque lock." To prevent torque lock, set the parking brake and then shift into PARK (P) properly before you leave the driver's seat. To find out how, see "Shifting Into PARK (P)" in the Index.

If torque lock does occur, you may need to have another vehicle push yours a little uphill to take some of the pressure from the parking pawl in the transmission, so you can pull the shift lever out of PARK (P).

Shifting Out of PARK (P)

CAUTION:

Before shifting out of PARK (P) you must fully apply your regular brakes. Your vehicle can roll. If you have left the engine running, the vehicle can move suddenly. You or others could be injured.

If you're pulling a trailer, see "Towing a Trailer" in the Index.

Your vehicle has a Brake-Transmission Shift Interlock (BTSI). You have to fully apply the regular brakes before you can shift from PARK (P) when the ignition is in ON. See "Automatic Transmission" in the Index.

If you cannot shift out of PARK (P), ease pressure on the shift lever -- push the shift lever all the way into PARK (P) as you maintain brake application. Then move the shift lever into the gear you want. If you ever hold the brake pedal down but still can't shift out of PARK (P), try this:

1. Turn the ignition key to OFF. Open and close the driver's door to turn off the Retained Accessory Power (RAP) feature.
2. Apply and hold the brake until the end of Step 8.



3. With both hands, squeeze the base of the shift lever boot (covering) together as shown.

4. Pull the upper part of the base out first and then slide out the lower part of the base.
5. Lift the shift lever boot (covering) up to get it out of your way.



6. At the bottom of the shift lever, you will see a yellow tab. With one hand, push the tab to unlock the shift lever.
7. Shift to NEUTRAL (N) with the other hand.
8. Start the engine (if you can) and then shift to the drive gear you want.
9. Have the vehicle fixed as soon as you can.

Parking Over Things That Burn

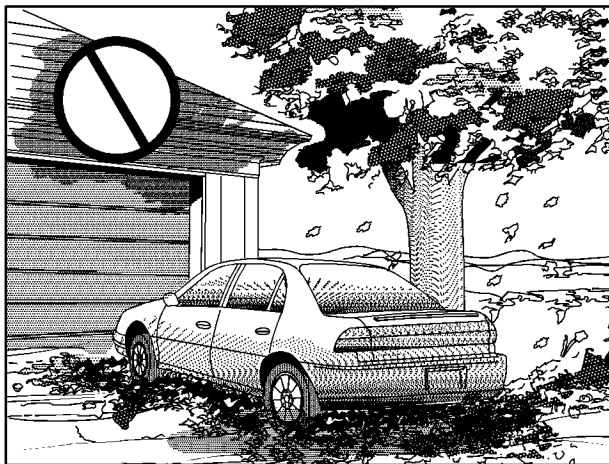

⚠ CAUTION:

Things that can burn could touch hot exhaust parts under your vehicle and ignite. Don't park over papers, leaves, dry grass or other things that can burn.

Engine Exhaust

⚠ CAUTION:

Engine exhaust can kill. It contains the gas carbon monoxide (CO), which you can't see or smell. It can cause unconsciousness and death.

You might have exhaust coming in if:

- Your exhaust system sounds strange or different.
- Your vehicle gets rusty underneath.
- Your vehicle was damaged in a collision.
- Your vehicle was damaged when driving over high points on the road or over road debris.
- Repairs weren't done correctly.
- Your vehicle or exhaust system had been modified improperly.

If you ever suspect exhaust is coming into your vehicle:

- Drive it only with all the windows down to blow out any CO; and
- Have your vehicle fixed immediately.

Running Your Engine While You're Parked

It's better not to park with the engine running. But if you ever have to, here are some things to know.

CAUTION:

Idling the engine with the climate control system off could allow dangerous exhaust into your vehicle (see the earlier Caution under “Engine Exhaust”).

Also, idling in a closed-in place can let deadly carbon monoxide (CO) into your vehicle even if the fan switch is at the highest setting. One place this can happen is a garage. Exhaust -- with CO -- can come in easily. **NEVER** park in a garage with the engine running.

Another closed-in place can be a blizzard. (See “Blizzard” in the Index.)

CAUTION:

It can be dangerous to get out of your vehicle if the shift lever is not fully in **PARK (P)** with the parking brake firmly set. Your vehicle can roll. Don't leave your vehicle when the engine is running unless you have to. If you've left the engine running, the vehicle can move suddenly. You or others could be injured. To be sure your vehicle won't move, even when you're on fairly level ground, always set your parking brake after you move the shift lever to **PARK (P)**.

Follow the proper steps to be sure your vehicle won't move. See “Shifting Into PARK (P)” in the Index.

If you are parking on a hill and if you're pulling a trailer, also see “Towing a Trailer” in the Index.

Windows

Power Windows



The controls are located next to the console shift lever. Tap the controls forward or rearward to raise or lower the windows in increments. To express-open the window, press the control rearward for about one second and then release. If you want to stop the window as it is lowering, tap the control. Pressing the control forward for about one second and then releasing it will express-close the window.

When you stop your vehicle and turn the ignition key to LOCK, you can still use the power windows. The electrical power to operate the windows will not shut off until the driver's door is opened -- there is no time limit to this feature. As soon as a door is opened, power window movement will stop immediately.

Programming the Power Windows

If the battery on your vehicle has been recharged, disconnected or is not working, you will need to reprogram each power window for the express-open and close features to work. Before reprogramming, you will need to replace or recharge your vehicle's battery.

To program each window, follow these steps:

1. Close all doors.
2. Press and hold the power window control until the window has fully opened.
3. Hold the power window control until the window is fully closed.
4. Continue holding the control down for approximately five seconds after the window is completely up.

The window is now programmed. Repeat the process for each window.

Anti-Pinch Feature

If a hand, an arm or another object is above the middle of the window and is in the way of the power window express-closing, the window will stop at the obstruction and express-open to a preset factory position.

CAUTION:

Pressing and holding the power window control button will turn off the anti-pinch feature. If this happens, a power window won't stop if something gets in the way. You or others could be injured, and your window could be damaged. Be careful not to press and hold the power window control button.

Rear Window Lockout



Pushing this button rearward will disable the rear passenger window controls. This is a useful feature if you have children as passengers. Press the button forward to allow your passengers to use their window controls.

Horn

The horn can be sounded by pressing either horn symbol on the steering wheel. The symbols are located at about the 9 and 3 o'clock positions.

Tilt Wheel



Tilt steering allows you to adjust the steering wheel before you begin driving. Raising the steering wheel to the highest level gives your legs more room when you enter and exit your vehicle.

Hold the steering wheel and pull the lever toward you to tilt the wheel. Adjust the steering wheel to a comfortable position and then release the lever to lock the wheel in place.

Turn Signal/Multifunction Lever



Turn and Lane Change Signals

To signal a turn, move the turn signal/multifunction lever all the way up or down. The lever returns automatically when the turn is complete.

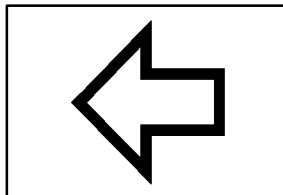

This arrow on the instrument panel will flash in the direction of the turn or lane change.

Raise or lower the lever until the arrow starts to flash to signal a lane change. Hold it there until the lane change is complete. The lever returns when it is released.

Arrows that flash rapidly when signaling for a turn or lane change may be caused by a burned-out front signal bulb. (This does not occur with a burned-out rear bulb.) Other drivers won't see the turn signal. Replace burned-out bulbs to help avoid possible accidents. Check the fuse (see "Fuses and Circuit Breakers" in the Index) and for burned-out bulbs if the arrow fails to work when signaling a turn.

Headlamp High/Low Beam

With the Twilight Sentinel[®] on or with the lamp control dial turned to the headlamp position, push the turn signal lever on the driver's side of the steering wheel away from you to turn on the high-beam headlamps.

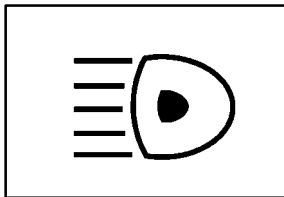

This light on the instrument panel will be on, indicating high-beam usage.

Pull the lever back to the original position to return to low-beam headlamps. For more information, see "Headlamps" in the Index.

Flash-To-Pass

This feature uses the high-beam headlamps to signal the driver in front of you that you want to pass. This feature will work with either the headlamps on or off.

To use, pull the turn signal lever toward you and release.

Windshield Wipers



WIPER: Move the lever on the passenger's side of the steering wheel up and down to control the wipers.

MIST: Tap the lever up and then release it for a single wipe cycle. For more cycles, pull and hold the lever.

= **(HIGH):** Move the lever all the way up for a fast wiper speed.

- **(LOW):** The third position up controls the low wiper speed.

-- **(DELAY):** This position is for a controlled delay setting. Rotate the control dial on the lever to increase or decrease the delay between wipe cycles.

o **(OFF):** This position turns off the wipers.

Be sure to clear ice and snow from the wiper blades before using them. If they're frozen to the windshield, carefully loosen or thaw them. If the blades do become damaged, replace them with new blades.

See "Windshield Wiper Blade Replacement" in the Index.

Heavy snow or ice can overload the wiper motor. A circuit breaker will stop the motor until it cools. Clear away snow or ice to prevent an overload.

Windshield Washer



Pull and hold the washer lever to wash the windshield. Release the lever when you have enough fluid. The wipers will clear the windshield and either stop or return to your preset speed.

CAUTION:

In freezing weather, don't use your washer until the windshield is warmed. Otherwise the washer fluid can form ice on the windshield, blocking your vision.

A telltale light on the instrument panel will be displayed when the washer fluid reaches a low level. See "Low Washer Fluid Warning Light" in the Index for more information.

Cruise Control



With cruise control, you can maintain a speed of about 25 mph (40 km/h) or more without keeping your foot on the accelerator. This can help on long trips. Cruise control does not work at speeds below about 25 mph (40 km/h).

Cruise control shuts off when you apply the brakes.

CAUTION:

- Cruise control can be dangerous where you can't drive safely at a steady speed. So, don't use your cruise control on winding roads or in heavy traffic.
- Cruise control can be dangerous on slippery roads. On such roads, fast changes in tire traction can cause needless wheel spinning, and you could lose control. Don't use cruise control on slippery roads.

If your vehicle is in cruise control when the traction control begins to limit wheel spin, the cruise control will automatically disengage. (See "Traction Control System" in the Index.) When road conditions allow you to safely use it again, you may turn the cruise control back on.

Setting Cruise Control

CAUTION:

If you leave your cruise control switch on when you're not using cruise, you might hit a button and go into cruise when you don't want to. You could be startled and even lose control. Keep the cruise control switch off until you want to use it.

1. Accelerate to the speed you want.



2. Press the SET/ACCEL. button at the end of the lever and release it.
3. Remove your foot from the accelerator pedal.

Resuming a Set Speed



Setting the cruise control at a desired speed and then applying the brake will end the cruise function. Once you're going about 25 mph (40 km/h) or more, you can press the RESUME/DECEL. button briefly to reset. This returns you to your desired preset speed.

If you hold the SET/ACCEL. button in briefly, the vehicle will accelerate until you release the button or apply the brake. So unless you want to go faster, don't hold the button in.

Increasing Speed While Using Cruise Control

There are two ways to go to a higher speed:

- Use the accelerator pedal to go to a higher speed. Push the SET/ACCEL. button at the end of the lever and then release the button and the accelerator pedal. You'll now cruise at a higher speed.
- Press the SET/ACCEL. button until the desired speed is reached. The new speed is maintained when the button is released. To increase your speed in very small amounts, tap the SET/ACCEL. button repeatedly. Each time you do this, your vehicle will go about 1 mph (1.6 km/h) faster.

The accelerate feature will only work after you have set the cruise control speed by pushing the SET/ACCEL. button.

Reducing Speed While Using Cruise Control

There are two ways to reduce your speed while using cruise control:

- Press the RESUME/DECEL. button at the end of the lever until you reach a desired lower speed, then release it.
- To slow down in very small amounts, tap the RESUME/DECEL. button repeatedly. Each time you do this, you'll go 1 mph (1.6 km/h) slower.

Passing Another Vehicle While Using Cruise Control

Use the accelerator pedal to increase your speed. When you take your foot off the pedal, your vehicle will slow down to the cruise control speed you set earlier.

Using Cruise Control on Hills

How well the cruise control will work on hills depends upon your speed, load and the steepness of the hills. When going up steep hills, you may have to step on the accelerator pedal to maintain your speed. When going downhill, you may have to brake or shift to a lower gear to keep your speed down. Of course, applying the brake takes you out of cruise control. Many drivers find this to be too much trouble and don't use cruise control on steep hills.

Ending Cruise Control

There are two ways to end cruise control:

- Step lightly on the brake pedal.
- Press the OFF button at the end of the cruise lever.

Erasing Speed Memory

The cruise control set speed memory is erased when you turn off the cruise control or the ignition.

Exterior Lamps



These controls on the left side of the instrument panel operate the following lamp systems:

 Lamp control dial (operates all lamps except the Twilight Sentinel, fog lamps and brightness control). Pull this dial toward you to turn on the interior lamps and push the dial back in to turn the lamps off.

 Parking lamps, front and rear sidemarker lamps, taillamps, license plate lamps, ashtray lamps, backlighting to the radio controls and instrument panel lights.

 Headlamps.

 Fog lamps.

TWILIGHT Twilight Sentinel.

OFF Turns the Twilight Sentinel system off.

 Instrument panel brightness control.

Turn the lamp control dial clockwise (to the first position) to turn on the parking lamps, front and rear sidemarker lamps, taillamps, license plate lamps, ashtray lamps, instrument panel lights and backlighting to the center console controls. Turn the lamp control dial all the way clockwise (to the second position) to turn on the low-beam headlamps.

Turn the lamp control dial counterclockwise to turn the lamps off.

Headlamps

Turn the lamp control dial all the way to the right to turn on the low-beam headlamps.

To turn on the high-beam headlamps, the low-beam headlamps must already be on. Push the turn signal lever on the left side of the steering wheel away from you to engage the high-beam headlamps. Pull the lever toward you to return to the low-beam headlamps. For more information, see “Headlamp High/Low Beam” in the Index.

Turn the lamp control dial all the way to the left to turn the headlamps off.

Note: If the headlamps are activated while driving and then you turn your vehicle’s ignition off while the lamp dial is still turned on, the headlamps will turn off. If, however, you open the driver’s door while the lamp dial is still turned on, a warning chime will sound reminding you to turn the lamp control dial to OFF. This will stop the warning chime from sounding. (If you want the headlamps to remain on, you must manually turn the lamp control dial off and then back on to the headlamp position. The headlamps will stay on until manually turned off again.)

Wiper-Activated Headlamps

This feature activates the low-beam headlamps, parking lamps, sidemarker lamps and taillamps after the windshield wipers have been in use for about 20 seconds.

The wiper-activated headlamps light the way in poor weather and also make your vehicle more visible to other drivers. If the wipers are on and the ignition switch is turned off, the headlamps will immediately turn off. The headlamps will also deactivate if the windshield wipers have been turned off for about 20 seconds.

Perimeter Lighting

This feature turns on the low-beam headlamps, parking lamps, sidemarker lamps and taillamps for about 20 seconds after the unlock button on the remote keyless entry transmitter is pressed. Perimeter lighting immediately ends when your vehicle's ignition is turned to ON or START.

Lamps On Reminder

You will hear a warning chime if you open the door while leaving the lamps on, if the manual headlamp control is activated. An exception to this is when you're using the Twilight Sentinel.

Daytime Running Lamps

Daytime Running Lamps (DRL) can make it easier for others to see the front of your vehicle during the day. DRL can be helpful in many different driving conditions, but they can be especially helpful in the short periods after dawn and before sunset.

The DRL system will make the high-beam headlamps come on at reduced brightness when:

- your vehicle's ignition is in ON or START,
- the low-beam headlamps are off (the manual lamp switch is in the off or park lamp position) and
- your vehicle's transmission is shifted out of PARK (P).

When DRL are on, only the high-beam headlamps (at reduced brightness) will be on. No other exterior lamps such as the parking lamps, taillamps, etc. will be on when the DRL are being used. The instrument panel won't be lit up either.

When the Twilight Sentinel is on and it's dark enough outside, the high-beam headlamps (at reduced intensity) will change to low-beam headlamps. When it's bright enough outside, the regular lamps will go off, and the high-beam headlamps change to the reduced brightness of DRL.

To idle your vehicle with the headlamps off, turn off the Twilight Sentinel switch and shift the transmission into PARK (P). Placing your vehicle in PARK (P) disables the DRL. The DRL will stay off until you shift out of PARK (P).

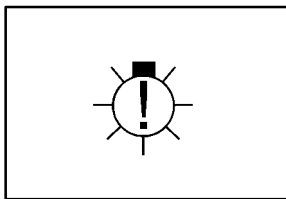

If you're not in PARK (P) and the Twilight Sentinel system is turned off (and it's dark enough outside), the DRL will remain active and this light on the instrument panel will appear.

This is a reminder that headlamps are required.

The following conditions will override the DRL:

- your vehicle's transmission is shifted back into PARK (P) with the ignition in ON or START,
- the low-beam headlamps are turned on (using the manual lamp control dial),
- the wiper-activated headlamps are in use (DRL will come back on 20 seconds after wipers have turned off),
- using the flash-to-pass feature and
- turning on the Twilight Sentinel.

As with any vehicle, you should turn on the regular headlamp system when you need it.

Fog Lamps



Use the fog lamps for better vision in foggy or misty conditions. Press this button to turn the fog lamps on and press the button again to turn the lamps off. (The fog lamps only work when the parking lamps or the low-beam headlamps are on and the ignition is on.)

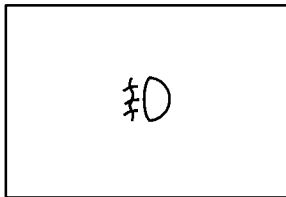

This light on the instrument panel will come on when the fog lamp button is pressed.

If you turn on the high-beam headlamps, the fog lamps will turn off. They'll turn back on again when you switch to low-beam headlamps.

Cornering Lamps

The cornering lamps come on when the headlamps or parking lamps are on and you signal a turn. They provide more light for cornering.

Twilight Sentinel®



This feature is below the lamp control dial on the left side of the instrument panel. It automatically switches the parking lamps and low-beam headlamps on and off by sensing how dark it is outside.

To operate the Twilight Sentinel, the ignition must be in ON or START and the Twilight Sentinel must be turned on by pressing the OFF button (an indicator light in the button will be off when the Twilight Sentinel is activated). If the system senses it is dark outside, the lamps will turn on. The lamps turn off when the system detects that it is bright outside.

If you rotate the control dial all the way up, the lamps will remain on for about three minutes after the ignition has been turned to OFF or LOCK. If you rotate the control dial all the way down, the lamps will go off quickly. You can adjust the delay time from a few seconds up to three minutes.

To turn the Twilight Sentinel off, press the OFF button again. The indicator light in the button will be on. This lets the driver know that the system has been turned off. The Twilight Sentinel also turns off if the ignition is turned to OFF or to LOCK.

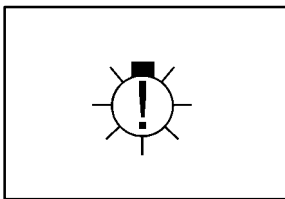

This light in the instrument panel will come on if the ignition is on and:

- the headlamps have not been manually turned on,
- the Twilight Sentinel senses it is dark outside,
- the Twilight Sentinel is OFF and
- the transmission is not in PARK (P).

Light Sensor

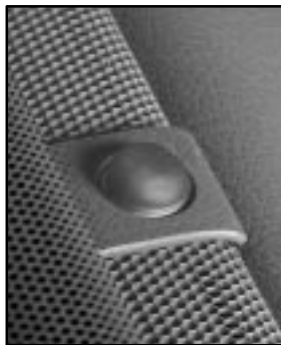

The light sensor for the Twilight Sentinel is located in the center of the front defogger grille, near the windshield.

If you cover the sensor, it will read “dark” and the parking lamps and low-beam headlamps will come on.

Interior Lamps

Instrument Panel Brightness Control

This control dial is located to the right of the fog lamp button. As you rotate the control dial up, the instrument panel lights will brighten.

Illuminated Entry

This system turns on the courtesy lamps (dome lamps and door entry lamps) for about 20 seconds when any of the following occur:

- if you manually unlock your vehicle with the key,
- if any door is opened,
- if you press the unlock button on the remote keyless entry transmitter, or
- after the last door on your vehicle is closed.

Illuminated entry immediately ends when your vehicle's ignition is turned to ON or START.

Rear Reading Lamps



The rear reading lamps are located above each rear door. These lamps and the interior courtesy lamps come on when any door is opened and it is dark outside.

Placing the button in the center position enables the lamps to come on when any door is opened. Pressing the button toward the rear of your vehicle disables the lamps when any door is opened. With the button set toward the front of the vehicle, the lamps will always be on.

If the reading lamps are left on, they automatically shut off 10 minutes after the ignition has been turned off.

Map Lamps



These lamps are located in the front overhead console (near the windshield). Press either button to turn the driver's or passenger's side lamp on and press the button again to turn the lamp off.

These lamps also come on when any door is opened or unlocked when it is dark outside.

Mirrors

Electrochromic Day/Night Rearview Mirror



This mirror automatically changes to reduce glare from headlamps behind you. A photocell on the back of the mirror senses when it is becoming dark outside. Another photocell built into the mirror surface senses when headlamps are behind you.

At night, when the glare is too high, the mirror will gradually darken to reduce glare (this change may take a few seconds). The mirror will return to its clear daytime state when the glare is reduced.

Cleaning Photocells

Use a cotton swab and glass cleaner to clean the front and rear photocells that make the auto-dimming feature work.

Time Delay

This feature prevents rapid changing of the mirror from the night mode to the day mode as you drive under lights and through traffic.

Power Remote Control Mirror



Move the rocker switch to the left to choose the driver's side mirror or move the switch to the right to select the passenger's side mirror. To adjust the mirror, push the control pad in the direction you want the mirror to go. Adjust each mirror so you can see the side of your vehicle and the area behind your vehicle.

Your vehicle's ignition must be in ON (II) for this feature to work.

Convex Outside Mirror

Your passenger's side mirror is convex. A convex mirror's surface is curved so you can see more from the driver's seat.



CAUTION:

A convex mirror can make things (like other vehicles) look farther away than they really are. If you cut too sharply into the right lane, you could hit a vehicle on your right. Check your inside mirror or glance over your shoulder before changing lanes.

Heated Rearview Mirrors

The manual folding outside rearview mirrors are heated. To heat the mirrors, press the rear window defogger button. See "Rear Window Defogger" in the Index.

Manual Folding Outside Rearview Mirrors

The driver's and passenger's outside mirrors move forward and rearward ("break-away") to help prevent injury and/or damage to your vehicle.

Storage Compartments

Glove Box

The glove box is located in front of the passenger's seat. To lock the glove box door, insert the key in the lock cylinder and turn it clockwise. Turn the key counterclockwise to unlock the door.

The glove box is air conditioned. This helps to keep snack items cool while traveling. In order for cool air to enter the glove box, the air conditioning must be turned on. Use the slide control inside and at the rear of the glove box to turn the air flow on and off. Moving the slide control over the small hole turns the cool air off and moving the control away from the hole turns the cool air on.

Map Pockets

The map/storage pockets are located on each front door as well as on the passenger's and driver's front seatbacks. Also located on the driver's door map pocket is a coin holder.

Center Console Storage Area



The front storage area comes with a small storage bin and a dual cupholder that unfolds for use. To open the lid of the storage bin, press and hold the button under the front edge of the storage lid and lift up. To use the cupholders, lift them up and out of the storage area. Fold them back down to return to the storage position.

Convenience Net

The convenience net is on the floor of the trunk. Put small loads, like grocery bags, under the net. It can help keep them from moving around during sharp turns or quick starts and stops.

The net is not for larger, heavier loads. Store them in the trunk as far forward as you can. When not using the net, hook it to the metal loops, securing it to the floor.

Ashtrays and Cigarette Lighter

The front ashtray is located below the radio. Press on the cover and release to access it. To clean the ashtray, press the black tab to the right of the tray to release it. Now pull up on the tray to remove and clean it.

To replace the tray after cleaning, follow these steps.

1. Hold the cover (flap) on top of the tray down so it is not in the way.
2. Insert the tray downward and forward into the ashtray holder.
3. Press down on the tray to snap it into place.

To use the rear ashtray, lift the lid.

NOTICE:

Don't put papers or other flammable items into the ashtrays. Hot cigarettes or other smoking materials could ignite them, causing a damaging fire.

The cigarette lighter is located next to the ashtray. Press it all the way in and release. It will pop back by itself when it's ready to light. You also have a lighter on the back of the center console near the rear seat air outlet.

These lighters (receptacles) work at all times, even when your vehicle's ignition has been turned off.

NOTICE:

Don't hold a cigarette lighter in with your hand while it is heating. If you do, it won't be able to back away from the heating element when it's ready. That can make it overheat, damaging the lighter and the heating element.

Sun Visors

Illuminated Visor Vanity Mirror

Turn the sunshade down and lift the cover to see the mirror. Lighting is automatic.

Rear Sunshade (Option)

The power rear sunshade helps reduce the amount of heat and light from the sun entering through the rear window. The sunshade increases the comfort level of the rear seat passengers as well as keeping your vehicle a little cooler when it's parked in a sunny area.



This button is located to the right of the shift lever on the center console.

To use, slide the button rearward -- the button returns to its original position when released.

The rear sunshade automatically raises. To lower the sunshade, slide the button rearward again.

Cellular Telephone (Option)

Your vehicle has been prewired for dealer installation of a dual-mode (analog/digital) cellular portable telephone. Voice activation and hands-free operation are standard features. For more information, contact your dealer. A user's guide is provided with the telephone.

OnStar[®] System (Option)

OnStar is a vehicle communications service which may be ordered through your dealer. The following OnStar services are available 24 hours a day:

- Roadside Service with Location
- Emergency Services Button
- Remote Door Unlock
- Theft Detection/Notification and Stolen-Vehicle Tracking
- Automatic Notification of Air Bag Deployment
- Concierge/Customer Convenience Services

For more information, contact your dealer.

Assist Handles

A handle above each door can be used when getting out of your vehicle.

Garment Hooks

For convenience, you will find garment hooks attached to each assist handle.

Floor Mats

Your vehicle is equipped with rubber-backed front and rear floor mats. Keep them clean by vacuuming and using a spot cleaner, if necessary. Do not machine wash.

Sunroof (Option)



The express-open sunroof can increase ventilation and it includes a sliding glass panel and a sliding sunshade. Power is supplied to the sunroof when the ignition key is turned to ON.

When you stop your vehicle and turn the ignition key to LOCK, you can still use the sunroof. The electrical power to operate the sunroof will not shut off until a door is opened -- there is no time limit to this feature. As soon as a door is opened, sunroof movement will stop immediately. See “Retained Accessory Power” in the Index.

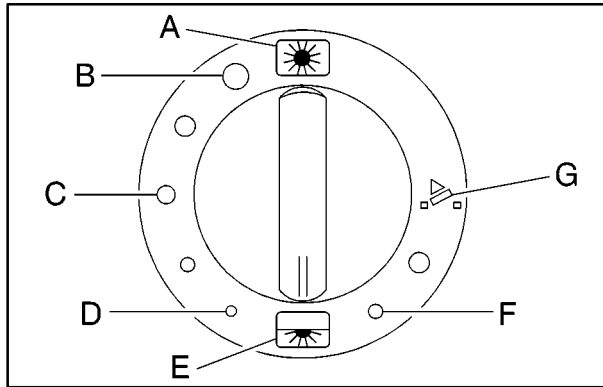

- | | |
|-------------------|---------------------|
| A. Fully Open | E. Fully Closed |
| B. About 80% Open | F. About 40% Tilted |
| C. About 50% Open | G. Fully Tilted |
| D. About 25% Open | |

Turning the control dial to position A fully opens the glass panel and sunshade. The sunshade can also be opened by hand. If you want to stop the roof in a partially opened position, turn the control dial to any position between A and E. The positions range from about 25 percent open to approximately 80 percent open. Turn the dial to position E to fully close the glass panel. To close the sunshade, pull it forward manually.

To raise the glass panel, turn the control dial counterclockwise to one of the three tilt positions. The positions range from about 40 percent tilted (F) to fully tilted (G). To close the vent, turn the dial clockwise to position E.

Anti-Pinch Feature

If a hand, an arm or another object is in the way of the power sunroof closing, the glass panel will stop at the obstruction and open to a preset factory position.

CAUTION:

Pressing and holding the power sunroof control dial in the up position will turn off the anti-pinch feature. If this happens, the sunroof won't stop if something gets in the way. You or others could be injured, and your sunroof could be damaged. Be careful not to press and hold the power sunroof control dial in the up position.

Manual Operation

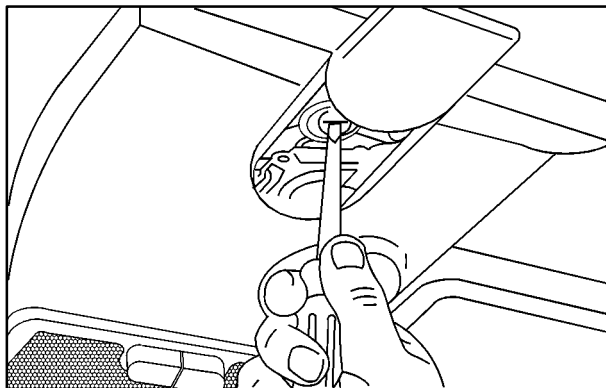

If a failure in the power supply system occurs, the sunroof can be manually closed by inserting a screwdriver into the slot as shown. Turning the screwdriver counterclockwise will close the sunroof.

The screwdriver is provided in the tool kit in the trunk (with the jack).

Programming the Sunroof

If the battery on your vehicle has been recharged, disconnected or is not working, you will need to reprogram the sunroof following these steps. Refer to the illustration under “Sunroof” for control dial positions.

With your vehicle’s ignition on:

1. If the sunroof is closed, turn the control dial to position E. Hold the dial in position for about five seconds.

If the sunroof is open, turn the control dial to E and hold until the glass panel has closed. Now continue holding the dial for approximately five more seconds.
2. Turn the control dial to position G and hold until the sunroof is fully tilted (about three seconds after the motor has stopped).
3. Now turn the control dial to position E and keep holding until the sunroof is fully closed (about three seconds after the motor has stopped).

4. Turn the control dial to position A and hold until the sunroof is fully open (about three seconds after the motor has stopped).
5. Turn to position E and keep holding the control dial until the sunroof has fully closed (about three seconds after the motor has stopped).

The sunroof is now programmed.

Note: If the sunroof keeps opening after you attempt to close it once it has been programmed, you will need to repeat Steps 2 through 5 (up to three times if needed). If you are still having problems, consult your dealer for service.

Also keep in mind that if something is in the way of the sunroof closing during programming and you continue to program the sunroof, the sunroof will only open or close to the spot where the obstruction occurred. You will need to reprogram the sunroof again, making sure that the object has been removed.

Universal Transmitter (If Equipped)

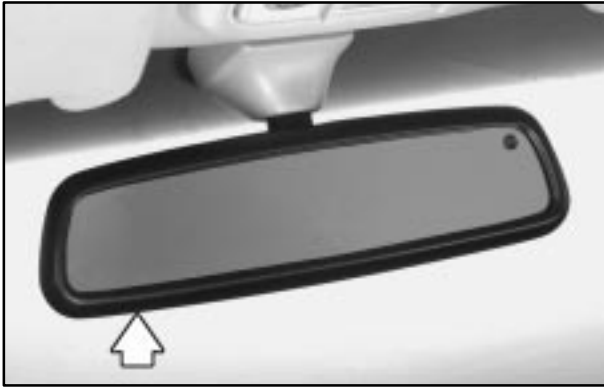

This transmitter allows you to consolidate the functions of up to three individual hand-held transmitters. It will operate garage doors and gates, or other devices controlled by radio frequency such as home/office lighting systems.

The Universal Transmitter will learn and transmit the frequencies of most current transmitters and is powered by your vehicle's battery and charging system.

This device complies with Part 15 of the FCC Rules. Operation is subject to the following two conditions: (1) this device may not cause harmful interference, and (2) this device must accept any interference received, including interference that may cause undesired operation.

This device complies with RSS-210 of Industry Canada. Operation is subject to the following two conditions: (1) this device may not cause interference, and (2) this device must accept any interference, including interference that may cause undesired operation of the device.

Changes and modifications to this system by other than an authorized service facility could void authorization to use this equipment.

Programming the Universal Transmitter

Do not use the Universal Transmitter with any garage door opener that does not have the “stop and reverse” safety feature. This includes any garage door opener model manufactured before April 1, 1982.

Be sure that people and objects are clear of the garage door you are programming.

Your vehicle’s engine should be turned off while programming the transmitter. Follow these steps to program up to three channels:

1. If you have previously programmed a transmitter channel, proceed to Step 2. Otherwise, hold down the two outside buttons on the Universal Transmitter until the indicator light begins to flash rapidly (after 20 seconds). Then release the buttons. This procedure initializes the memory and erases any previous settings for all three channels.
2. Decide which one of the three channels you want to program. Hold the end of the hand-held transmitter about 2 to 5 inches (5 to 13 cm) away from the surface of the Universal Transmitter so that you can still see the indicator light.
3. Using both hands, press the hand-held transmitter button and the desired button on the Universal Transmitter. Continue to press both buttons through Step 4.
4. Hold down both buttons until you see the indicator light on the Universal Transmitter flash slowly and then rapidly. The rapid flashing indicates that the Universal Transmitter has been programmed. Release both buttons once the indicator light starts to flash rapidly.

If you have trouble programming the Universal Transmitter, make sure that you have followed the directions exactly as described. The Universal Transmitter may not work with older garage door openers that do not meet current Federal Consumer Safety Standards. If you cannot program the transmitter after repeated attempts, refer to “Rolling Code Programming” later in this section or contact the Universal Transmitter manufacturer at 1-800-355-3515.

Be sure to keep the original hand-held transmitter in case you need to erase and reprogram the Universal Transmitter.

Note to Canadian Owners: During programming, the hand-held transmitter may automatically stop transmitting after one or two seconds. In this case, you should press and re-press the button on the hand-held transmitter every two seconds without ever releasing the button on the Universal Transmitter. Release both buttons when the indicator light on the Universal Transmitter begins to flash rapidly.

Operating the Universal Transmitter

Press and release the appropriate button on the Universal Transmitter. The indicator light comes on while the signal is being transmitted.

If the hand-held transmitter appears to program the Universal Transmitter but does not open your garage door, and if the garage door opener was manufactured after 1996, the garage door opener may have a “rolling code” system. A rolling code system changes the code of the garage door opener every time you open or close the garage door.

To determine if you have this system, press the button on the Universal Transmitter that you have programmed already. If the indicator light on the Universal Transmitter flashes rapidly for two seconds and then turns solid, the garage door opener has a rolling code system. In a rolling code system, the garage door motor head unit must be trained to the Universal Transmitter.

“Rolling Code” Programming (If Equipped)

If you have not previously programmed the hand-held transmitter to the Universal Transmitter, see “Programming the Universal Transmitter” listed previously. If you have completed this programming already, you now need to train the garage door opener motor head unit to recognize the Universal Transmitter. Refer to your garage door opener owner’s manual for the proper transmitter training procedure for your garage door opener brand.

1. Find the training button on the garage door opener motor head unit. The exact location and color of the button may vary by garage door opener brand. If you have difficulty finding the training button, refer to your garage door opener owner's manual.
2. Press the training button on the garage door opener motor head unit.

Note: Following this step, you have 30 seconds to start Step 3.

3. Return to the Universal Transmitter in your vehicle and firmly press and release the Universal Transmitter button you have already programmed for two to three seconds. Press and release the button again (you may need to do this step up to three times) to make sure that the Universal Transmitter has been trained to the garage door opener motor head unit. Check that the training was successful.

The garage door opener should now recognize the Universal Transmitter. You may either use the Universal Transmitter or the hand-held transmitter to open the garage door.

If after following these instructions, you still have problems training the garage door opener, contact the Universal Transmitter manufacturer at 1-800-355-3515.

Erasing Channels

To erase all three programmed channels, hold down the two outside buttons until the indicator light begins to flash (after 20 seconds). Release both buttons.

Accessories

Accessories for the Universal Transmitter are available from the manufacturer of the unit. If you would like additional information, please call 1-800-355-3515.

Instrument Panel

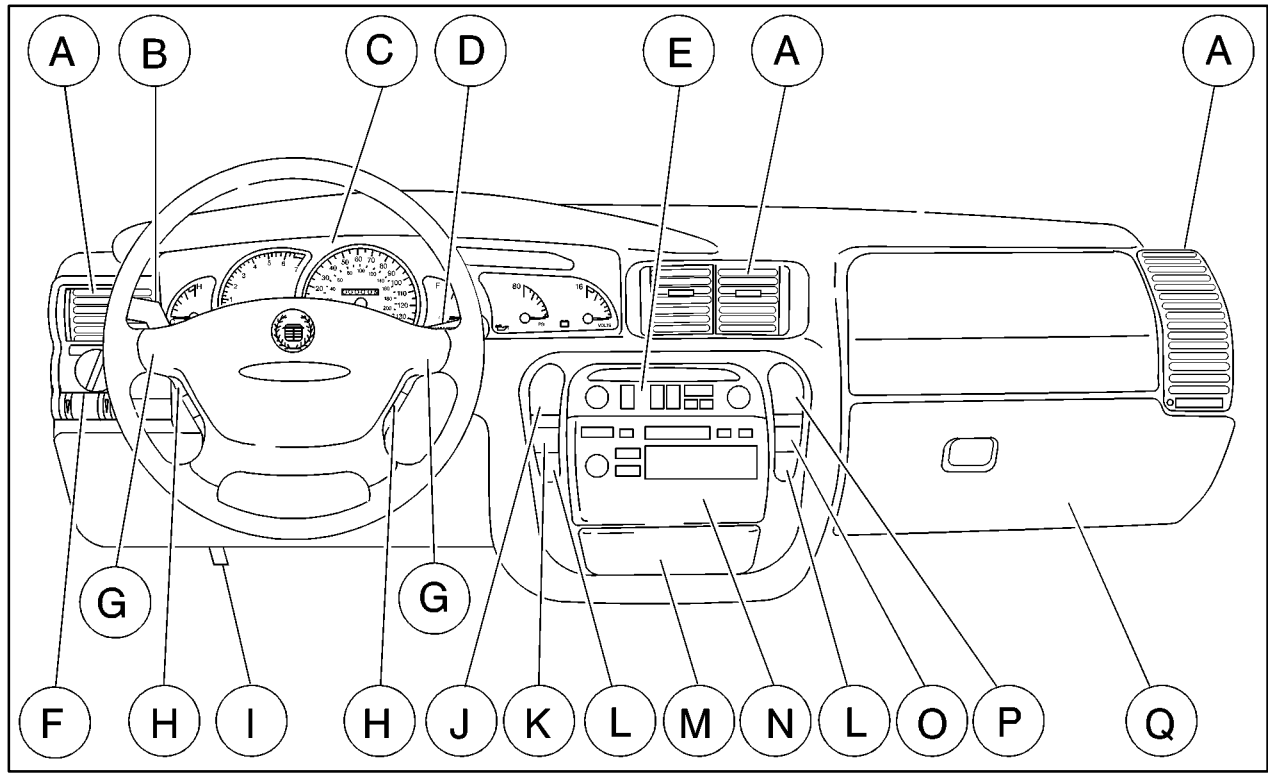

The instrument panel is designed to let you know at a glance how your vehicle is running. You'll know how fast you're going, how much fuel you're using and many of the other things you'll need to know to drive safely and economically. The main components of the instrument panel are:

- A. Air Outlets
- B. Turn Signal/Multifunction Lever
- C. Instrument Cluster
- D. Windshield Wiper/Washer Lever
- E. Comfort Controls
- F. Lamp Controls
- G. Horn
- H. Steering Wheel Touch Controls for Audio System
- I. Hood Release
- J. Hazard Warning Flasher Button
- K. Fuel Door Release Button
- L. Heated Front Seat On/Off Button (Option)
- M. Ashtray
- N. Radio
- O. Trunk Release Button
- P. Traction Control On/Off Button
- Q. Glove Box

Instrument Panel Cluster

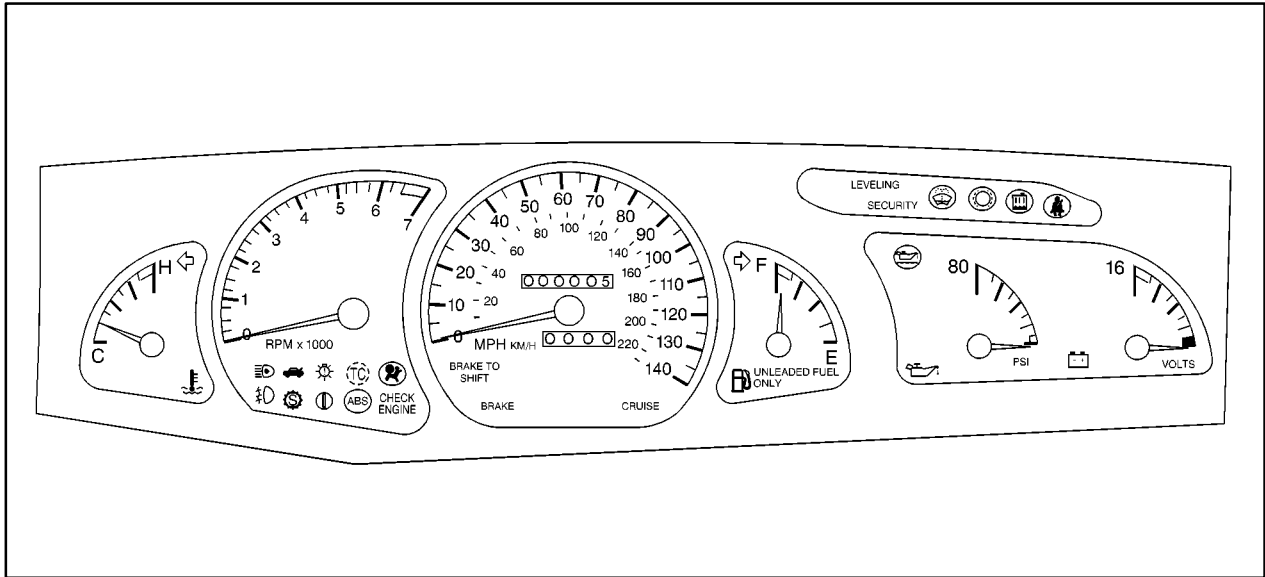

United States version shown, Canadian similar

Speedometer and Odometer

The speedometer lets you see your speed in both miles per hour (mph) and kilometers per hour (km/h). The odometer shows how far your vehicle has been driven, in either miles (used in the United States) or kilometers (used in Canada).

Trip Odometer

The trip odometer tells how far you have driven since you last reset it. To set it to zero, press the knob located below the speedometer on the instrument cluster.

Tachometer

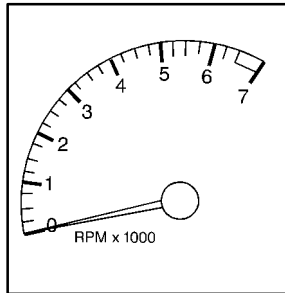

This gage indicates the engine speed in revolutions per minute (rpm).

NOTICE:

Do not operate the engine with the tachometer in the red area or engine damage may occur.

Engine Speed Limiter

This feature prevents the engine from operating at too many revolutions per minute (rpm). When the engine's rpm are critically high, the fuel supply to the engine is shut off. When the engine speed slows, the fuel supply will come on again. This helps prevent damage to the engine.

Warning Lights, Gages and Indicators

This part describes the warning lights and gages that may be on your vehicle. The pictures will help you locate them.

Warning lights and gages can signal that something is wrong before it becomes serious enough to cause an expensive repair or replacement. Paying attention to your warning lights and gages could also save you or others from injury.

Warning lights come on when there may be or is a problem with one of your vehicle's functions. As you will see in the details on the next few pages, some warning lights come on briefly when you start the engine just to let you know they're working. If you are familiar with this section, you should not be alarmed when this happens.

Gages can indicate when there may be or is a problem with one of your vehicle's functions. Often gages and warning lights work together to let you know when there's a problem with your vehicle.

When one of the warning lights comes on and stays on when you are driving, or when one of the gages shows there may be a problem, check the section that tells you what to do about it. Please follow this manual's advice. Waiting to do repairs can be costly -- and even dangerous. So please get to know your warning lights and gages. They're a big help.

Safety Belt Reminder Light

When the key is turned to ON or START, a tone will come on for about eight seconds to remind people to fasten their safety belts, unless the driver's safety belt is already buckled.



The safety belt light will also come on and stay on for about four seconds, then it will flash for about 60 seconds.

If the driver's belt is already buckled, neither the tone nor the light will come on.

Air Bag Readiness Light

There is an air bag readiness light on the instrument panel, which shows the air bag symbol. The system checks the air bag's electrical system for malfunctions. The light tells you if there is an electrical problem. The system check includes the air bag sensors, the air bag modules, the wiring and the diagnostic module. For more information on the air bag system, see "Air Bag" in the Index.

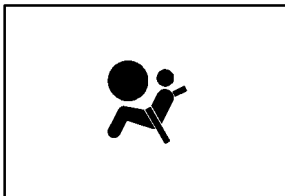

This light will come on when you start your engine, and it will flash for a few seconds. Then the light should go out. This means the system is ready.

If the air bag readiness light stays on after you start the engine or comes on when you are driving, your air bag system may not work properly. Have your vehicle serviced right away.

The air bag readiness light should flash for a few seconds when you turn the ignition key to ON. If the light doesn't come on then, have it fixed so it will be ready to warn you if there is a problem.

Charging System Indicator Light

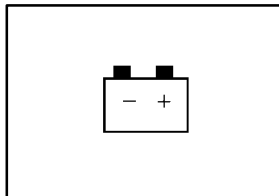

When you turn the key to START, this light will come on briefly to show that the generator and battery charging systems are working.

If this light stays on, you need service and you should take your vehicle to the dealer at once. To save the battery until you get there, turn off all accessories.

Voltmeter

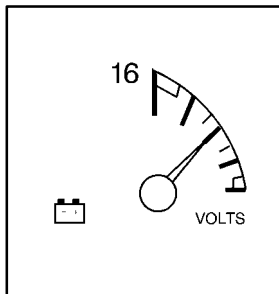

You can read battery voltage on the voltmeter. If it reads less than 12 volts or more than 16 volts while the engine is running, and it stays there, you may have a problem with the electrical charging system.

Have it checked right away. Driving with the voltmeter reading in the lower warning zone could drain or damage the battery. Driving with the voltmeter reading in the upper warning zone could cause bulbs to burn out (especially headlamp bulbs), various vehicle modules to shut down (due to overload protection) and the possibility of a battery acid leak.

If you idle the engine for a while, the voltmeter reading might move into the red zone. If the reading stays in the red zone while you are driving, you may have a problem with the electrical charging system. Have it checked. While the voltmeter reads in the red zone, the battery may not be able to power certain electrical accessories, like ABS. (If this happens, the ABS light will come on. See “Anti-Lock Brakes System Warning Light” in this section.)

If you must drive a short distance with the voltmeter reading in a warning zone, turn off all the accessories, including the comfort controls and the audio system.

Brake System Warning Light

Your vehicle’s hydraulic brake system is divided into two parts. If one part isn’t working, the other part can still work and stop you. For good braking, though, you need both parts working well.

If the warning light comes on, there is a brake problem. Have your brake system inspected right away.



United States

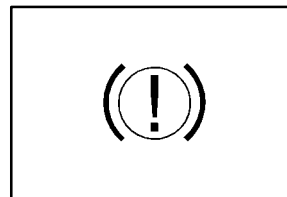

Canada

This light should come on briefly when you turn the ignition key to ON. If it doesn’t come on then, have it fixed so it will be ready to warn you if there’s a problem.

If the light comes on while you are driving, pull off the road and stop carefully. You may notice that the pedal is harder to push. Or, the pedal may go closer to the floor. It may take longer to stop. If the light is still on, have the vehicle towed for service. (See “Towing Your Vehicle” in the Index.)

**CAUTION:**

Your brake system may not be working properly if the brake system warning light is on. Driving with the brake system warning light on can lead to an accident. If the light is still on after you've pulled off the road and stopped carefully, have the vehicle towed for service.

When the ignition is on, the brake system warning light will also come on when you set your parking brake. The light will stay on if your parking brake doesn't release fully. If it stays on after your parking brake is fully released, it means you have a brake problem.

Anti-Lock Brake System Warning Light



ABS

With the anti-lock brake system, the light(s) will come on when you start your engine and may stay on for several seconds. That's normal.

If the light stays on, turn the ignition to OFF. Or, if the light comes on when you're driving, stop as soon as possible and turn the ignition off. Then start the engine again to reset the system. If the light still stays on, or comes on again while you're driving, your vehicle needs service. If the regular brake system warning light isn't on, you still have brakes, but you don't have anti-lock brakes. If the regular brake system warning light is also on, you don't have anti-lock brakes and there's a problem with your regular brakes. See "Brake System Warning Light" earlier in this section.

The anti-lock brake system warning light should come on briefly when you turn the ignition key to ON. If the light doesn't come on then, have it fixed so it will be ready to warn you if there is a problem.

Traction Control System Warning Light

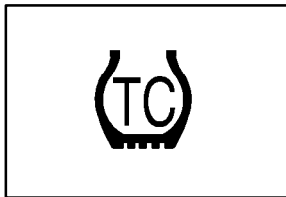

This warning light will flash when the system senses a traction change.

If it stays on, or comes on and stays on steady when you're driving, there may be a problem with your traction control system and your vehicle may need service. When this warning light is on, the system will not limit wheel spin. Adjust your driving accordingly.

The traction control system warning light may come on for the following reasons:

- If there's a brake system problem that is specifically related to traction control, the traction control system will turn off and the warning light will come on.
- If the traction control system is affected by an engine-related problem, the system will turn off and the warning light will come on.

If the traction control system warning light comes on and stays on for an extended period of time when the system is turned on, your vehicle needs service.

Engine Coolant Temperature Warning Light

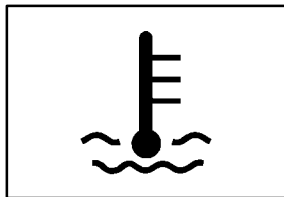

This light tells you that the engine has overheated. If this light comes on, you should stop the vehicle and turn the engine off as soon as possible.

A warning chime should also sound if this light comes on.

As a check, the light should come on for a few seconds when you start the engine. See "Engine Overheating" in the Index.

Engine Coolant Temperature Gage

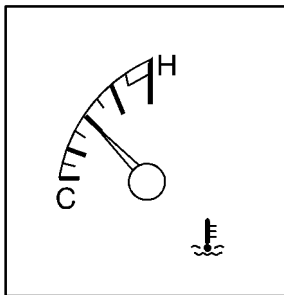

This gage shows the engine coolant temperature. If the gage pointer moves into the red area, the engine is too hot!

This reading means the same thing as the warning light -- the engine coolant has overheated. You should stop the car and turn the engine off as soon as possible. See “Engine Overheating” in the Index.

Low Coolant Warning Light

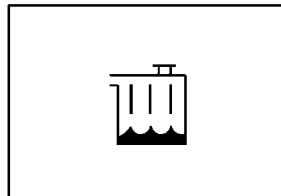

This warning light should come on for a few seconds while you are starting the engine. If the light doesn't come on, have it repaired.

Your vehicle is equipped with a low coolant level sensor (switch and float) that is designed to detect when your vehicle's coolant level drops below the set limit. If the low coolant level sensor (under the coolant surge tank) detects that the level drops while the engine is running, the low coolant indicator will light and remain lit until the ignition switch is turned off. Check the coolant level and add coolant as needed. The light should turn off as soon as the coolant level is at its proper operating range.

Malfunction Indicator Lamp (Check Engine Light)

A rectangular box with a black border containing the words "CHECK ENGINE" in a bold, black, sans-serif font, arranged in two lines.

Your vehicle is equipped with a computer which monitors operation of the fuel, ignition and emission control systems.

This system is called OBD II (On-Board Diagnostics-Second Generation) and is intended to assure that emissions are at acceptable levels for the life of the vehicle, helping to produce a cleaner environment. The CHECK ENGINE light comes on to indicate that there is a problem and service is required. Malfunctions often will be indicated by the system before any problem is apparent. This may prevent more serious damage to your vehicle. This system is also designed to assist your service technician in correctly diagnosing any malfunction.

NOTICE:

If you keep driving your vehicle with this light on, after a while, your emission controls may not work as well, your fuel economy may not be as good and your engine may not run as smoothly. This could lead to costly repairs that may not be covered by your warranty.

NOTICE:

Modifications made to the engine, transmission, exhaust or fuel system of your vehicle or the replacement of the original tires with other than those of the same Tire Performance Criteria (TPC) can affect your vehicle's emission controls and may cause the CHECK ENGINE light to come on. Modifications to these systems could lead to costly repairs not covered by your warranty. This may also result in a failure to pass a required Emission Inspection/Maintenance test.

This light should come on, as a check to show you it is working, when the ignition is on and the engine is not running. If the light doesn't come on, have it repaired. This light will also come on during a malfunction in one of two ways:

- **Light Flashing** -- A misfire condition has been detected. A misfire increases vehicle emissions and may damage the emission control system on your vehicle. Dealer or qualified service center diagnosis and service may be required.
- **Light On Steady** -- An emission control system malfunction has been detected on your vehicle. Dealer or qualified service center diagnosis and service may be required.

If the Light Is Flashing

The following may prevent more serious damage to your vehicle:

- Reducing vehicle speed.
- Avoiding hard accelerations.
- Avoiding steep uphill grades.
- If you are towing a trailer, reduce the amount of cargo being hauled as soon as it is possible.

If the light stops flashing and remains on steady, see “If the Light Is On Steady” following.

If the light continues to flash, when it is safe to do so, *stop the vehicle*. Find a safe place to park your vehicle. Turn the key off, wait at least 10 seconds and restart the engine. If the light remains on steady, see “If the Light Is On Steady” following. If the light is still flashing, follow the previous steps, and drive the vehicle to your dealer or qualified service center for service.

If the Light Is On Steady

You may be able to correct the emission system malfunction by considering the following:

Did you recently put fuel into your vehicle?

If so, reinstall the fuel cap, making sure to fully install the cap. See “Filling Your Tank” in the Index. The diagnostic system can determine if the fuel cap has been left off or improperly installed. A loose or missing fuel cap will allow fuel to evaporate into the atmosphere. A few driving trips with the cap properly installed should turn the light off.

Did you just drive through a deep puddle of water?

If so, your electrical system may be wet. The condition will usually be corrected when the electrical system dries out. A few driving trips should turn the light off.

Are you low on fuel?

As your engine starts to run out of fuel, your engine may not run as efficiently as designed since small amounts of air are sucked into the fuel line causing a misfire. The system can detect this. Adding fuel should correct this condition. Make sure to install the fuel cap properly. See “Filling Your Tank” in the Index. It will take a few driving trips to turn the light off.

Have you recently changed brands of fuel?

If so, be sure to fuel your vehicle with quality fuel (see “Fuel” in the Index). Poor fuel quality will cause your engine not to run as efficiently as designed. You may notice this as stalling after start-up, stalling when you put the vehicle into gear, misfiring, hesitation on acceleration or stumbling on acceleration. (These conditions may go away once the engine is warmed up.) This will be detected by the system and cause the light to turn on.

If you experience one or more of these conditions, change the fuel brand you use. It will require at least one full tank of the proper fuel to turn the light off.

If none of the above steps have made the light turn off, have your dealer or qualified service center check the vehicle. Your dealer has the proper test equipment and diagnostic tools to fix any mechanical or electrical problems that may have developed.

Oil Pressure Light/Gage

The light and gage tell you if there could be a problem with the engine oil pressure.

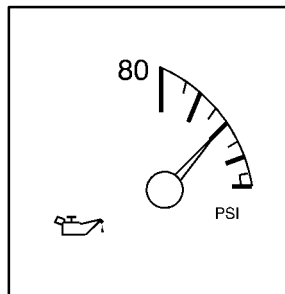

The gage shows the engine oil pressure in pounds per square inch (psi). Canadian vehicles show pressure in kilopascals (kPa).

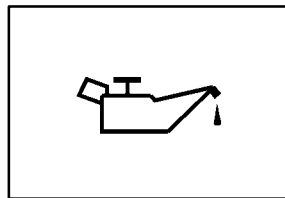

The oil light goes on when you turn the key to ON or START. It goes off once you start the engine. That’s a check to be sure the light works.

If it doesn’t come on, be sure to have it fixed so it will be there to warn you if something goes wrong.

When the light *comes* on and *stays* on, it means that oil isn't flowing through the engine properly. You could be low on oil and you might have some other system problem.

CAUTION:

Don't keep driving if the oil pressure is low. If you do, your engine can become so hot that it catches fire. You or others could be burned. Check your oil as soon as possible and have your vehicle serviced.

NOTICE:

Damage to your engine from neglected oil problems can be costly and is not covered by your warranty.

Check Oil Light

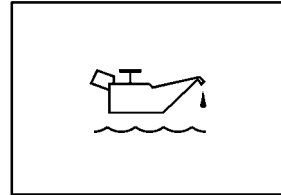

This light will come on for a few seconds when the ignition is turned on. If the light doesn't come on, have it repaired.

If the light comes on while starting and stays on for about one minute or comes on while driving, the engine oil level should be checked. Prior to checking the oil level, be sure your vehicle has been shut off for several minutes and is on a level surface. Check the oil level and bring it to the proper level. See "Engine Oil" in the Index.

Brake To Shift Light

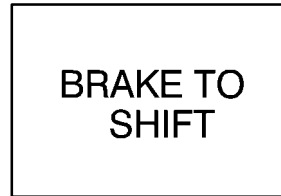

This light will come on to remind you that you must press the brake pedal to shift out of PARK (P).

Cruise Control Light

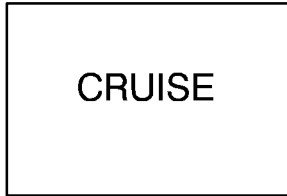

This light comes on whenever you set your vehicle's cruise control.

Trunk Ajar Light

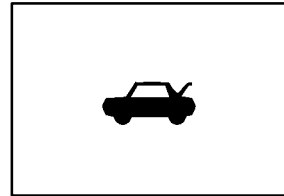

This light will come on if your vehicle's trunk is not completely closed.

Low Washer Fluid Warning Light

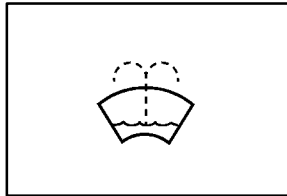

This light will come on when you turn on the ignition and the windshield washer fluid container is less than one-third full.

Fuel Gage

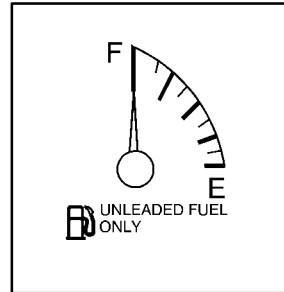

The fuel gage shows approximately how much fuel is in the tank. It works only when the ignition is in ON.

Here are a few concerns some owners have had about the fuel gage. All of these situations are normal and do not indicate that anything is wrong with the fuel gage.

- At the gas station the gas pump shuts off before the gage reads F.
- The gage may change when you turn, stop or speed up.

Low Fuel Light

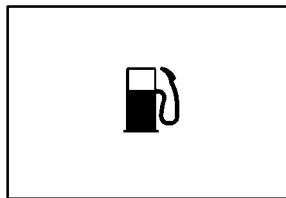

If the fuel level is low, approximately two gallons (7.57 L) of fuel remaining in the fuel tank, a light will come on and stay on.

When the fuel level reaches one gallon (8.8 L), the light will flash until fuel is added.

It will also come on for a few seconds when you first turn on the ignition as a check to show it's working. If it doesn't come on then, have it fixed.

Fuel Cap Indicator Light (If Equipped)

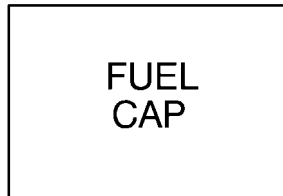

This light will come on if the fuel cap has not been fully tightened, is missing or has been improperly installed.

You should recheck your fuel cap to make sure it is on tight.

If you continue to drive with a loose fuel cap, the diagnostic system in your vehicle can determine if the fuel cap has been left off or improperly installed. A loose or missing fuel cap will allow fuel to evaporate into the atmosphere. If this happens, the CHECK ENGINE light may come on. For more information, see "Malfunction Indicator Lamp" earlier in this section.

Automatic Transmission Warning Light (If Equipped)

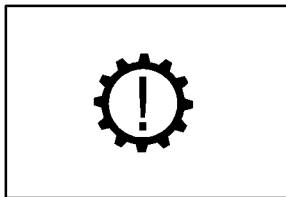

This light comes on briefly when the ignition is turned on. If the light remains on or lights up while driving, there may be a fault in the automatic transmission. Have your vehicle serviced.

Leveling Indicator Light



This light comes on steady when the rear load level in your vehicle changes.

Do not drive your vehicle when this light is on. The rear of your vehicle is too low and part of the body or the rear axle may be damaged when driving over bumpy roads. When the light goes out, leveling is complete. This procedure is automatic -- you don't have to do anything.

If the light comes on flashing, there may be a problem with the leveling system. You should reduce your vehicle speed and have your vehicle serviced soon.

Brake Pad Wear Indicator Light

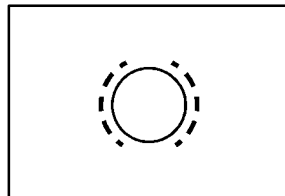

This light comes on when the brake pads on your vehicle have significantly worn. The pads will have to be replaced, so have your vehicle serviced soon.



Section 3 Comfort Controls and Audio Systems

In this section, you'll find out how to operate the comfort control and audio systems offered with your vehicle. Be sure to read about the particular systems supplied with your vehicle.

3-2	Comfort Controls	3-22	Radio Data Systems (RDS) Program Type (PTY) Selections
3-2	Electronic Climate Control (ECC)	3-23	CD Adapter Kits
3-3	Automatic Operation	3-23	Trunk-Mounted CD Changer (Option)
3-4	Manual Operation	3-27	Theft-Deterrent Feature
3-6	Air Conditioning	3-27	Audio Steering Wheel Controls
3-6	Heating	3-28	Understanding Radio Reception
3-6	Defrosting	3-28	Tips About Your Audio System
3-7	Rear Window Defogger	3-29	Care of Your Cassette Tape Player
3-7	Ventilation System	3-30	Care of Your Compact Discs
3-9	Audio Systems	3-31	Care of Your Compact Disc Player
3-9	Setting the Clock	3-31	Heated Backlite Antenna
3-9	AM-FM Stereo with Cassette Tape Player		
3-13	AM-FM Stereo with Cassette Tape and Compact Disc Player with Radio Data Systems (RDS) (If Equipped)		

Comfort Controls

This section tells you how to make your air system work for you. Your comfort control system uses ozone-friendly R-134a refrigerant.

You can control the heating, cooling and ventilation systems in your vehicle. Guidelines for using these systems are found later in this section.

Electronic Climate Control (ECC)

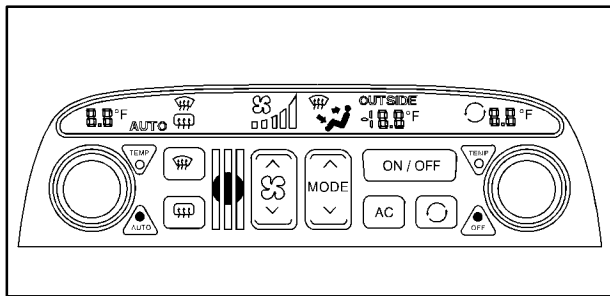

Fan Button

The button with the fan symbol adjusts the fan speed. Press the up arrow to increase fan speed and the down arrow to decrease fan speed.

Driver's Side Temperature Knob

The driver's side TEMP/AUTO knob adjusts the air temperature coming through the system. Turn the TEMP/AUTO knob clockwise to increase the temperature and counterclockwise to decrease the temperature. Pressing this knob puts the climate control system in an automatic mode. For more information, see "Automatic Operation" later in this section.

Passenger's Side Temperature Knob

The right front passenger can control the temperature of heated air for their own zone, independent from the driver's temperature setting. The passenger's temperature can be set anywhere between 60°F (16°C) and 90°F (32°C).

To turn the system on, press the passenger's side TEMP/OFF knob. Turn the knob clockwise to increase temperature and counterclockwise to decrease. Pressing the knob again turns off the dual-zone function and returns the system to the one-zone function, where the driver controls the temperature.

Outside Temperature Display

The outside temperature is always displayed when your vehicle's ignition is on. If the outside temperature display begins to flash, this means that icy road conditions are possible. Adjust your driving if needed. The display will flash for about 30 seconds and then remain on steady.

Mode Button

Press this button to deliver air through the floor, middle or windshield outlets. The climate control system will stay in the selected ECC mode until the MODE button is pressed again or until the TEMP/AUTO knob is pressed. Press the up or down arrow to see the available modes.

English/Metric Display

You can change the temperature display from English (degrees Fahrenheit) to metric (degrees Celsius) by pressing and holding the driver's side TEMP/AUTO knob for approximately five seconds. Repeat the process to change back to English from metric.

Automatic Operation

Pressing the driver's side TEMP/AUTO knob sets the system for automatic operation. Once the system is set, sensors will control the air delivery mode. Air will come from the floor, middle, side or windshield outlets. The fan speed will vary as the system maintains the selected temperature setting. (All previous manually set mode settings will change back to a fully automatic mode when the climate control system is turned on this way.)

Be careful not to put anything over the solar sensor located in the middle of the instrument panel near the windshield. This sensor is used by the automatic system to regulate temperature.

To find your comfort zone, start with the 75°F (24°C) setting and allow about 20 minutes for the system to regulate air temperature. Adjust the temperature if necessary. If you choose 60°F (16°C), the system will remain at that maximum cooling setting and will not regulate fan speed. If you choose the temperature of 90°F (32°C), the system will remain at that maximum heating setting and will not regulate fan speed. Choosing either maximum setting will not cause the system to heat or cool any faster.

In cold weather, when the system senses the need for heat, airflow will be directed out of the floor outlets. As the interior temperature approaches a desired setting, the blower speed will decrease. To maintain interior comfort, the airflow may move to the instrument panel air outlets and floor outlets (bi-level mode). On bright sunny days in cold weather, the airflow may come out of the air conditioning outlets (AC mode) to maintain comfort and prevent stuffiness.

If your vehicle is sitting out on a hot day and you have the climate control system set for automatic operation, the air will first flow out of the floor air outlets during cool down. That is normal. This is to remove hot air from the air outlets. As the air is cooled, the airflow will move through the air conditioning outlets.

To avoid blowing cold air in cold weather, the system will delay turning on the fan until warm air is available. The length of delay depends on the outside air temperature, engine coolant temperature or the time since the engine was last started. As the coolant warms up, the blower fan speed will gradually increase and air will flow from the heater outlets, with some airflow to the windshield to prevent fogging under most normal conditions.

If you leave your vehicle, the system will remember the control setting the next time you start your engine, except for recirculation and rear defrost (heated backlite). Each ignition cycle cancels recirculation.

Manual Operation

You may manually adjust the air delivery mode or fan speed.



HEATER/DEFROST: This setting directs air to the floor outlets and toward the windshield.



AC: This setting directs airflow through the middle instrument panel outlets.



BI-LEVEL: This setting directs air into your vehicle in two ways. Cool air is directed to the upper portion of your body through the middle instrument panel outlets while warm air is directed to the floor.



HEATER: This setting directs warm air through the floor outlets. Some warm air is sent to the windshield to minimize fogging.

 **DEFROST:** Press this button to quickly remove fog or frost from the windshield (the blower works in high-speed). This setting sends most of the airflow to the windshield with only a small amount to the floor outlets.

 **FAN SPEEDS:** Press the driver's side TEMP/AUTO knob to set the fan speed for AUTO. At this setting, the fan speed is automatically controlled. If it is cold outside, the blower may not run in the maximum high fan speed right away. The system checks the temperature of the engine coolant to assure it is warm enough to provide heat. When the engine coolant is warm, the controller allows the fan to gradually increase to a higher speed. This prevents cold air from blowing into the passenger compartment. If you want the blower fan at a high speed, press the up arrow button until you reach the highest position of the display. If you want the blower fan at a low speed, press the down arrow button until the lowest position is displayed.

ON/OFF: Press this button to turn the system off. Press this button again to turn the system back on. Turning the climate control system on in this way will recall all previous manually set mode settings. If the system is turned on by pushing the driver's TEMP/AUTO knob for automatic operation, all of the previous manually set mode settings will be changed back to the fully automatic mode.

AC: Press this button to turn the air conditioning on and off. The system will cool and dehumidify the air inside the vehicle. In the automatic operation mode, the display will show AC OFF when the air conditioning has been turned off.

 **RECIRCULATION:** Press this button to limit the amount of fresh air entering your vehicle. This is helpful to limit odors entering your vehicle. In the automatic operation mode, the system will use recirculation as necessary to cool the air. Pressing the recirculation button will change the operation to a manual mode and the air will recirculate non-stop. Press this button again to turn off the recirculation feature.

If you notice the windows fogging, press the recirculation button to exit the recirculation mode.

Air Conditioning

On hot days, open the windows long enough to let hot inside air escape. This reduces the time it takes for your vehicle to cool down. Then keep your windows closed for the air conditioner to work its best.

The climate control system will cool and dehumidify the air inside the vehicle. While in the automatic operation mode, the system will use recirculation as necessary to cool the air. You may also need to adjust the interior temperature. Turn either the TEMP/AUTO or TEMP/OFF knob clockwise to increase the temperature or counterclockwise to decrease temperature. Adjust the fan speed as needed.

In order to obtain the maximum cool setting, both the driver's TEMP/AUTO knob and the passenger's TEMP/OFF knob must be turned to 60°F (16°C).

Heating

Adjust the interior temperature to your comfort level by turning the TEMP/AUTO knob or the TEMP/OFF knob clockwise to increase the temperature or counterclockwise to decrease the temperature. If the fan speed needs adjusting, press the up or down arrow.

Outside air will be brought in and sent through the floor outlets. The heater works best if you keep the windows closed while using it.

In order to obtain the maximum heat setting, both the driver's TEMP/AUTO knob and the passenger's TEMP/OFF knob must be turned to 90°F (32°C).

Defrosting

Use defrost to remove fog or ice from the windshield quickly in extremely humid or cold conditions.

Pressing the defrost button on the control panel (located above the rear window defogger button) automatically turns the fan blower to high speed. Make sure that the side air vents are opened. Turn both the TEMP/AUTO knob and the TEMP/OFF knob clockwise as needed to adjust the temperature. To warm the foot area while in defrost, press the MODE button until the heater/defrost symbol appears (see "Manual Operation" earlier in this section).

Note: Recirculation is not available in the defrost mode.

Rear Window Defogger

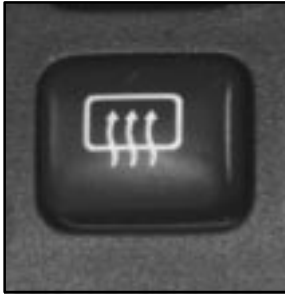

The lines you see on the rear window warm the glass. With your vehicle's engine running, press this button to turn on the rear defogger.

The rear window defogger heats the rear window and both outside rearview mirrors. The system will automatically shut off after about 15 minutes. If further defogging is desired, press the button again.

Do not attach a temporary vehicle license, tape or decals across the defogger grid on the rear window.

NOTICE:

Do not try to clear frost or other material from the inside of the rear window with a razor blade or anything else that is sharp. This may damage the rear defogger grid. The repairs wouldn't be covered by your warranty.

Ventilation System

The ventilation system supplies outside air into the vehicle when it is moving. Outside air will also enter the vehicle when the heater or the air conditioning fan is running.



The front outlets are located in the center and at each side of the instrument panel. You can adjust the direction of airflow by moving the center control levers or you can stop the airflow by moving the dial located on each side of the outlets to the “O” position.

The direction of airflow for the rear seats can also be adjusted. Move the center control dial between each vent up or down to adjust the airflow from low to high. Turn the dial to the “O” position to stop airflow. Move the lever in the center of each vent to direct airflow toward the upper or floor outlets.

The airflow temperature from the rear outlets is the same as the driver’s temperature setting.

Ventilation Tips

- Keep the hood and front air inlet free of ice, snow or any other obstruction (such as leaves). The heater and defroster will work far better, reducing the chance of fogging the inside of the windows.
- When you enter a vehicle in cold weather, adjust the fan to the highest speed for a few moments before driving off. This helps clear the intake outlets of snow and moisture, and reduces the chance of fogging the inside of the windows.
- Keep the air path under the front seats clear of objects. This helps circulate air throughout your vehicle.

Passenger Compartment Air Filter

This ventilation system includes an air filter that helps to remove dust, pollen, etc. from air flowing into your vehicle. A restriction in the airflow coming into the passenger compartment could be the result of dirt in the filter. For more information, see “Passenger Compartment Air Filter Replacement” in the Index. Also see the Maintenance Schedule booklet for when to change the filter.

Audio Systems

Your Cadillac audio system has been designed to operate easily and give years of listening pleasure. You will get the most enjoyment out of it if you acquaint yourself with it first. Find out what your audio system can do and how to operate all its controls, to be sure you're getting the most out of the advanced engineering that went into it.

Setting the Clock

Press and hold HR or MN until the time display begins to change. Release the button as you get close to the correct time. The time may be set anytime the clock is displayed. There is a two-second delay before the clock goes into time-set mode.

AM-FM Stereo with Cassette Tape Player



Playing the Radio

PWR/VOL: Press this knob lightly to turn the system on. Press the knob again to turn the system off. To increase volume, turn the knob clockwise. Turn it counterclockwise to decrease volume. The volume level will appear on the display.

HR or MN: Display the time with the ignition off by pressing this button.

DSPL: Press this button to display the radio station being played.

Finding a Station

BAND: Press this button to select AM, FM1 or FM2.

SEEK-TUNE: Press and release this button to seek to the next higher or lower radio station. Pressing and holding this button until a chime sounds puts the radio in a tune mode. In this mode, higher or lower radio stations are advanced to in small increments until the SEEK-TUNE button is released. Tuning stops when you release this button. If you press and hold the SEEK-TUNE button again within five seconds of being in the tune mode, tuning will continue. Waiting longer than five seconds places the radio back in the seek mode.

SCAN: Press this button and SCAN will appear on the display. Use SCAN to listen to stations for a few seconds. The radio will go to a station, stop for a few seconds, then go on to the next station. Press this button again to stop scanning.

PUSHBUTTONS: The six numbered pushbuttons let you return to your favorite stations. You can set up to 18 stations (six AM, six FM1 and six FM2). Just:

1. Turn the radio on.
2. Press BAND to select AM, FM1 or FM2.
3. Tune in the desired station.
4. Press and hold one of the six numbered buttons for more than two seconds until you hear a beep. Whenever you press that numbered button for less than two seconds, the station you set will return.
5. Repeat the steps for each pushbutton.

When battery power is removed and later applied, you will not have to reset your radio presets because the radio remembers them.

PRESET SCAN: Press and hold SCAN for two to three seconds until PRESET SCAN appears on the display to listen to each of your preset stations for a few seconds (factory presets which have not been reprogrammed with your stations will be ignored). The radio will go to the first preset station stored on your pushbuttons, stop for a few seconds, then go on to the next preset station. Press SCAN again to stop scanning. If a preset station has weak reception, the radio will not stop at the preset station.

Setting the Tone

BASS: Press this knob lightly so it extends. Turn the knob clockwise to increase and counterclockwise to decrease bass.

TREB: Press this knob lightly so it extends. Turn the knob clockwise to increase and counterclockwise to decrease treble. If a station is weak or noisy, you may want to decrease the treble.

Push these knobs back into their stored positions when you're not using them.

Adjusting the Speakers

BAL: Press this knob lightly so it extends. Turn the knob clockwise to adjust sound to the right speakers and counterclockwise for the left speakers. The middle position balances the sound between the speakers.

FADE: Press this knob lightly so it extends. Turn the knob clockwise to adjust the sound to the front speakers and counterclockwise for the rear speakers. The middle position balances the sound between the speakers.

Push these knobs back into their stored positions when you're not using them.

Playing a Cassette Tape

With the radio on, insert a cassette tape. The tape will begin playing as soon as it is inserted. When one side of your cassette tape is done playing, auto reverse plays the other side of your cassette tape. If you want to insert a cassette tape when the ignition is off, first press the eject button.

While the tape is playing, use the VOL, FADE, BAL, BASS and TREB controls just as you do for the radio. Other controls may have different functions when a tape is inserted. The display will show TAPE with an arrow to indicate which side of the tape is playing. PLAY will appear on the display temporarily when a tape is playing. The display will then revert back to showing the time.

If an error occurs while trying to play a cassette tape, it could be that:

- The cassette tape is tight and the cassette player cannot turn the hubs of the tape. Hold the cassette tape with the open end down and try turning the right hub counterclockwise with a pencil. Flip the tape over and repeat. If the hubs do not turn easily, your cassette tape may be damaged and should not be used in the player. Try a new tape to be sure your player is working properly.
- The cassette tape is broken. (Check to see if your tape is broken. Try a new tape.)

REV: Press the left arrow to rewind the tape rapidly. The radio will play while the tape reverses and REV will appear on the display. You may use your station pushbuttons to tune to another radio station while in REV mode. Press the left arrow again to return to playing speed.

FF: Press the right arrow to fast forward to another part of the tape. The radio will play while the tape advances and FF will appear on the display. You may use your station pushbuttons to tune to another radio station while in FF mode. Press the right arrow again to return to playing speed.

SEEK-TUNE: Press the right arrow to seek to the next selection on the tape. Press the left arrow to search for the previous selection on the tape (REP will appear on the display). Your tape must have at least three seconds of silence between each selection for SEEK-TUNE to work. The sound will mute while seeking.

SCAN: Press this button. SCAN FF will appear on the display until the next selection is found and then SCAN PLAY will appear on the display. Use SCAN to listen to selections for a few seconds. The tape will go to a selection, stop for a few seconds, then go on to the next selection. Press this button again to stop scanning.

SIDE: Press this button to change the side of the tape that is playing. (PLAY shows on the display.)

SOURCE: Press this button to select a source. If no cassette tape is in the tape player, CASS appears on the display and then the radio station appears briefly. The display then reverts back to showing the time of day. Press this button again or press BAND to switch back to the radio.

△ **EJECT:** Press the upward triangle button to remove a tape. The radio will play. Eject may be activated with the radio off. Eject tapes may be loaded with the radio off but they will not start playing until the PWR button is pressed. Press PWR or turn the ignition off to stop the cassette tape player. The tape will stay in the player and resume play at the point where it stopped.

CLN: If this message appears on the display, the cassette tape player needs to be cleaned. It will still play tapes, but you should clean it as soon as possible to prevent damage to the tapes and player. See “Care of Your Cassette Tape Player” in the Index. After you clean the player, press and hold the eject button for five seconds to reset the CLN indicator. The radio will display --- to show the indicator was reset.

Your cassette tape player automatically reduces background noise from tapes encoded with Dolby NR. Dolby Noise Reduction is manufactured under a license from Dolby Laboratories Licensing Corporation. Dolby and the double-D symbol are trademarks of Dolby Laboratories Licensing Corporation.

AM-FM Stereo with Cassette Tape and Compact Disc Player with Radio Data Systems (RDS) (If Equipped)



Playing the Radio

PWR/VOL: Press this knob lightly to turn the system on. Press the knob again to turn the system off. To increase volume, turn the knob clockwise. Turn it counterclockwise to decrease volume.

HR or MN: Display the time with the ignition off by pressing this button.

SOURCE: Press this button to select a source. Sources include cassette and compact disc. The audio source must be loaded to play. Available loaded sources are shown on the display. If a source is being used, it will be underlined on the display. If none of the audio sources are loaded, NO SOURCE LOADED will appear on the display. Press this button again or press BAND to switch back to the radio.

Finding a Station

BAND: Press this button to select AM, FM1, FM2 or weather.

TUNE-SEEK: When this button is pressed it has two positions. Press this button to the first position to manually tune to higher or lower stations. If this button is held at the first position for a few seconds, the radio will continue tuning until this button is released. Press this button to the second position and release to seek to the next higher or lower radio station.

SCAN: Press this button for less than two seconds to scan radio stations. The radio will go to a station, stop for five seconds, then go on to the next station. Press this button again to stop scanning.

PUSHBUTTONS: The six numbered pushbuttons let you return to your favorite stations. The RDS PTY mode must be off to use this mode. You can set up to 24 stations (six AM, six FM1, six FM2 and six weather). Just:

1. Turn the radio on.
2. Press BAND to select AM, FM1, FM2 or weather.
3. Tune in the desired station.
4. Press and hold one of the six numbered buttons for more than two seconds. Whenever you press that numbered button for less than two seconds, the station you set will return.
5. Repeat the steps for each pushbutton.

When battery power is removed and later applied, you will not have to reset your radio presets because the radio remembers them.

PRESET SCAN: Press and hold SCAN for more than two seconds until you hear a beep to listen to each of your preset stations for five seconds. The radio will go to the first preset station stored on your pushbuttons, stop for five seconds, then go on to the next preset station. Press SCAN again to stop scanning. If a preset station has weak reception, the radio will not stop at the preset station.

Using RDS Mode

Your audio system is equipped with Radio Data Systems (RDS). RDS mode gives you many useful new features. When RDS is on, the radio can:

- seek only to stations with the types of programs you want to listen to,
- seek to stations with traffic announcements,
- receive announcements concerning local and national emergencies,
- receive and display messages from radio stations and
- search for a stronger station when a station is too weak for listening.

RDS features are only available for use on FM stations which broadcast RDS information.

RDS SELECT: Press this button to use the alternate RDS functions (RDS, TA, MSG, PTY and < PTY >) located on the six numbered pushbuttons. RDS SELECT: will appear on the display. The alternate RDS functions are only available when you are using the FM band of your radio.

RDS (1): With RDS off, press the RDS SELECT button, followed by this button to turn RDS on. The RDS display will turn on. You must have RDS on to use the new RDS functions. The RDS display will also turn on if one of the other RDS function buttons has been pressed on. If you are tuned to a station broadcasting RDS information, the station's call letters and Program Type (PTY) will replace the station's frequency on the display. After five seconds, the program type will be replaced on the display by the station's program type name. The program type and program type name may be the same or different. Press BAND to recall the frequency and program type displays. If the radio is tuned to a station that is not broadcasting RDS information, the station's frequency will remain on the display. While RDS is on, the radio will search for a stronger station in the network when a station gets too weak for listening. Press the RDS SELECT button, followed by this button again to turn RDS off. All RDS functions will be turned off.

REGION: You can also use the RDS button to access the region function. When an RDS station becomes weak, this function searches for a stronger station within the same network. A network can span a great distance. One network can have stations spread across a country or continent. Each network breaks down into regions. With regions, local news items like weather and traffic are available to you. When the region function is on, the radio only searches for stations in the same network and region. You can only use the region function when RDS is already on. Press the RDS SELECT button. Then press and hold the RDS button for two seconds. **REGION: ON** will appear on the display. While **REGION: ON** appears on the display, press the RDS button again to turn the region function off. **REGION: OFF** will appear on the display. The region function can be turned on again by pressing the RDS button.

TA (2): Press the RDS SELECT button, followed by this button to receive traffic announcements. The radio will turn on the TA display. **TP** will appear on the display if the tuned station broadcasts traffic announcements. You may also receive traffic announcements from stations in the network related to the tuned station. If the current tuned station does not broadcast traffic announcements, the radio will seek to a station which does. When the radio finds a station which broadcasts traffic announcements, it will stop.

If no station is found, **NONE FOUND** will appear on the display. When **SEEK** or **SCAN** is pressed with the traffic announcement function on, the radio will only stop at stations which broadcast traffic announcements.

While a traffic announcement plays, the radio uses a special type of volume called **TA volume**. To increase **TA volume**, turn the **PWR/VOL** knob clockwise. Turn it counterclockwise to decrease volume. **TA VOLUME** will appear on the display while the volume is being adjusted.

When a traffic announcement comes on the tuned radio station or a related network station, you will hear it, even if the volume is muted or a cassette tape or compact disc is playing. If the radio tunes to a related network station for a traffic announcement, it will return to the original station when the announcement is finished. If the cassette tape or compact disc player was being used, the tape or compact disc will stay in the player and resume play at the point where it stopped.

Press the RDS SELECT button, followed by this button again to turn **TA** off.

MSG (3): When RDS is on, if the current station has a message, MSG will appear on the display. Press the RDS SELECT button, followed by this button to see the message. If the whole message does not appear on the display, parts of the message will appear every three seconds until the message is completed. To see the parts of the message faster than every three seconds, press this button again. A new group of words will appear on the display. Once the complete message has been displayed, MSG will disappear from the display until another new MSG is received.

PTY (4): This button is used to turn on and off Program Type (PTY) seeks and scans. Press the RDS SELECT button, followed by this button. The PTY display will turn on. RDS SELECT: PTY NEWS will appear on the display for three seconds. (The PTY shown will be the last PTY selected.) Press the RDS SELECT button, followed by this button again to turn the PTY display off.

<PTY> (5) (6): With RDS on, press the RDS SELECT button, followed by < or >. The PTY display will turn on, if it is not already on. RDS SELECT: PTY NEWS will appear on the display for three seconds. (The PTY shown will be the last PTY selected.) While this message is displayed, use < and > to move up and down the PTY list. If you pause on a PTY for three seconds, PRESET PTY: NEWS will appear on the display. While this message is displayed, you can save the PTY in a preset by pressing one of the six numbered pushbuttons until you hear a beep. Allow three seconds for the message to disappear if you do not want to save the PTY in a preset. See “Radio Data Systems (RDS) Program Type (PTY) Selections” in the Index.

When the PTY display is on, press SEEK and SCAN to find radio stations of the PTY you want to listen to. The last PTY selected will be used for seek and scan modes. If a station with the selected PTY is not found, NONE FOUND will appear on the display. If both PTY and TA are on, the radio will search for stations with traffic announcements and the selected PTY.

PUSHBUTTONS: The six numbered pushbuttons let you return to your favorite Program Types (PTYs). These buttons have factory PTY presets. See “Radio Data Systems (RDS) Program Type (PTY) Selections” in the Index. You can set up to 12 PTYs (six FM1 and six FM2). Just:

1. Turn PTY on.
2. Press BAND to select FM1 or FM2.
3. Tune in an RDS station with the PTY you desire.
4. Press and hold one of the six numbered buttons for more than two seconds until you hear a beep. Whenever you press that numbered button for less than two seconds, the PTY you set will return.
5. Repeat the steps for each pushbutton.

When battery power is removed and later applied, you will not have to reset your RDS presets because the radio remembers them.

HR or **MN:** Press the RDS SELECT button, followed by one of these buttons to display the time for the current station. STATION TIME IS will be displayed. If a time has not been sent to the radio, NO STATION TIME will be displayed. If you have recently tuned to the station, you may need to wait a minute before the

time is available to the radio. To set the clock to the current displayed station time, press and hold HR or MN until TIME UPDATED is displayed. There is a two second delay before the time is updated. RDS mode does not have to be on to use this function, but you must be tuned to an FM RDS station.

ALERT: This type of announcement warns of national or local emergencies. You will not be able to turn off alert announcements. Alert announcements will come on even if RDS mode is turned off. ALERT appears on the display when an alert announcement plays. The radio uses TA volume during these announcements. To increase volume, turn the PWR/VOL knob clockwise. Turn it counterclockwise to decrease volume. TA VOLUME will appear on the display while the volume is being adjusted. When an alert announcement comes on the tuned radio station or a related network station, you will hear it, even if the volume is muted or a cassette tape or compact disc is playing. If the radio tunes to a related network station for an alert announcement, it will return to the original station when the announcement is finished. If the cassette tape or compact disc player is playing, play will stop for the announcement and resume when the announcement is finished.

Setting the Tone

TONE: Press and release this button until the desired tone control (BASS or TREBLE) is found. The radio keeps separate tone settings for each band, preset (except weather band presets) and source.

LEVEL: After selecting the desired tone control, press the plus (+) or minus (-) symbol on this button to select the desired level.

To save the tone settings for your presets, press and hold the numbered button for the desired preset for more than two seconds until you hear a beep.

Adjusting the Speakers

 **SPEAKER:** Press and release this button until the desired BALANCE or FADE control is found.

LEVEL: After selecting the desired BALANCE or FADE control, press the plus (+) or minus (-) symbol on this button to select the desired level.

Playing a Cassette Tape

With the radio on, insert a cassette tape. The tape will begin playing as soon as it is inserted. When one side of your cassette tape is done playing, auto reverse plays the other side of your cassette tape. Cassette tapes may be loaded with the radio off but they will not start playing until the radio is on. If you want to insert a cassette tape when the ignition is off, first press the eject button.

While the tape is playing, use the VOL, TONE, LEVEL and SPEAKER controls just as you do for the radio. Other controls may have different functions when a tape is inserted. The display will show an underlined tape symbol. TAPE PLAY will appear on the display when a tape is playing, with an arrow to indicate which side of the tape is playing.

If an error occurs while trying to play a cassette tape, it could be that:

- The cassette tape is tight and the cassette player cannot turn the hubs of the tape. Hold the cassette tape with the open end down and try turning the right hub counterclockwise with a pencil. Flip the tape over and repeat. If the hubs do not turn easily, your cassette tape may be damaged and should not be used in the player. Try a new tape to be sure your player is working properly.
- The cassette tape is broken. (Check to see if your tape is broken. Try a new tape.)

RW: Press the left arrow to rewind the tape rapidly. The radio will play while the tape rewinds. You may use your station pushbuttons to tune to another radio station while in RW mode. Press the left arrow again to return to playing speed.

FF: Press the right arrow to fast forward to another part of the tape. The radio will play while the tape advances. You may use your station pushbuttons to tune to another radio station while in FF mode. Press the right arrow again to return to playing speed.

TUNE-SEEK: When this button is pressed, it has two positions. This button works the same, whether it is pressed to the first or second position. Press this button to seek to the next or previous selection on the tape. Your tape must have at least three seconds of silence between each selection for TUNE-SEEK to work. The sound will mute while seeking.

SCAN: Press this button to listen to selections for a few seconds. The tape will go to a selection, stop for a few seconds, then go on to the next selection. Press this button again to stop scanning.

SIDE: Press this button to change the side of the tape that is playing.

EJECT: Press the upward triangle button to the right of the cassette tape player to remove a tape. The radio will play. Eject may be activated with the radio off and/or the ignition off.

CLEAN TAPE: If this message appears on the display, the cassette tape player needs to be cleaned. It will still play tapes, but you should clean it as soon as possible to prevent damage to the tapes and player. See “Care of Your Cassette Tape Player” in the Index. After you clean the player, press and hold the eject button for three seconds to reset the CLEAN TAPE indicator.

Your cassette tape player automatically reduces background noise from tapes encoded with Dolby NR. Dolby Noise Reduction is manufactured under a license from Dolby Laboratories Licensing Corporation. Dolby and the double-D symbol are trademarks of Dolby Laboratories Licensing Corporation.

Auto CrO₂ allows the cassette tape player to adjust to the type of cassette tape for clearer sound for CrO₂ cassette tapes.

Playing a Compact Disc

Insert a disc partway into the slot, label side up. The player will pull it in. If the ignition and the radio are on and the underlined compact disc symbol appears on the display, the disc will begin playing. Compact discs may be loaded with the radio off but they will not start playing until the radio is on. If you want to insert a disc when the ignition is off, first press the eject button.

The integral CD player can play the smaller 8 cm compact discs. Full-size compact discs and the smaller compact discs are loaded in the same manner.

If you're driving on a very rough road or if it's very hot, the disc may not play. If the disc comes out, it could be that:

- The disc is upside down.
- It is dirty, scratched or wet.
- The air is very humid. (If so, wait about an hour and try again.)

If any error occurs repeatedly or if an error can't be corrected, please contact your dealer.

RW: Press and hold the left arrow to reverse the compact disc. Release it to return to playing speed.

FF: Press and hold the right arrow to fast forward to another part of the compact disc. Release it to return to playing speed.

TUNE-SEEK: When this button is pressed, it has two positions. This button works the same, whether it is pressed to the first or second position. Press this button to seek to the next or previous selection on the compact disc.

SCAN: Press this button to listen to selections for a few seconds. The compact disc will go to a selection, stop for a few seconds, then go on to the next selection. Press this button again to stop scanning.

RDM: Press this button to hear the tracks in random, rather than sequential, order. Press RDM again to turn off random play.

△ EJECT: Press the upward triangle button to the right of the compact disc player to remove a compact disc. The radio will play. Eject may be activated with the radio off and/or the ignition off.

Radio Data Systems (RDS) Program Type (PTY) Selections

PTY List	Description	PTY List	Description
Adlt Hit	Adult Hits	Persnlty	Personality
Any	Any	Public	Public
Classicl	Classical	R & B	Rhythm and Blues
Cls Rock	Classical Rock	Rel Musc	Religious Music
College	College	Rel Talk	Religious Talk
Country	Country	Rock M	Rock Music
Info	Information	Soft	Soft
Jazz	Jazz	Soft Rock	Soft Rock
Language	Language	Sports	Sports
News	News	Talk	Talk
Nostalga	Nostalgia	Top 40	Top 40
Oldies	Oldies	Weather	Weather

Factory PTY Presets

Preset	FM1	FM2
Preset 1	Adult Hits	Jazz
Preset 2	Classical	Oldies
Preset 3	News	Religious Music
Preset 4	Public	Soft Rock
Preset 5	Rock	R & B
Preset 6	Country	Top 40

CD Adapter Kits

It is possible to use a CD adapter kit with your cassette tape player after activating the bypass feature on your tape player.

To activate the bypass feature, use the following steps:

1. Turn the ignition to ON (II).
2. Turn the radio off.
3. Press and hold the SOURCE button for two seconds. The tape symbol on the display will flash three times, indicating the feature is active.
4. Insert the adapter.

This override routine will remain active until the eject button is pressed.

Trunk-Mounted CD Changer (Option)

With the compact disc changer, you can play up to 12 discs continuously. Normal size discs may be played using the trays supplied in the magazine. The smaller discs (8 cm) can be played only with specially designed trays.



You must first load the magazine with discs before you can play a compact disc. Each of the 12 trays holds one disc. Press the button on the back of the magazine and pull gently on one of the trays. Load the trays from bottom to top, placing a disc on the tray label side down. If you load a disc label side up, the disc will not play and an error will occur. Gently push the tray back into the magazine slot. Repeat this procedure for loading up to 12 discs in the magazine.



Once you have loaded the discs in the magazine, slide open the door of the compact disc (CD) changer. Push the magazine into the changer in the direction of the arrow marked on top of the magazine.



Close the door by sliding it all the way to the left. When the door is closed, the changer will begin checking for discs in the magazine. This will continue for up to one and a half minutes, depending on the number of discs loaded.

To eject the magazine from the player, slide the CD changer door all the way open. The magazine will automatically eject. Remember to keep the door closed whenever possible to keep dirt and dust from getting inside the changer.

Whenever a CD magazine with discs is loaded in the changer, the CD changer symbol will appear on the radio display. If the CD changer is checking the magazine for CDs, the CD symbol will flash on the display until the changer is ready to play. When a CD begins playing, a disc and track number will be displayed. The disc numbers are listed on the front of the magazine.

All of the CD functions are controlled by the radio buttons, except for ejecting the CD magazine.

PUSHBUTTONS: Press buttons one through six to select compact discs one through six. Press and hold one of the six pushbuttons until a beep sounds to select compact discs 7 through 12. These pushbuttons represent the order of the discs loaded in the changer.

DSPL: Press and hold this button to see the track elapsed time. (This button is available on the AM-FM Stereo with Cassette Tape Player only.)

REV/RW: Press and hold this button to reverse quickly through a track selection.

FF: Press and hold this button to advance quickly through a track selection.

If your vehicle is equipped with the AM-FM Stereo with Cassette Tape Player, use SEEK-TUNE. For all other audio systems, use TUNE-SEEK.

SEEK-TUNE: Press the right arrow to seek to the next selection. Press the left arrow to search for the previous track selection. The sound will mute while seeking.

TUNE-SEEK: When this button is pressed, it has two positions. This button works the same, whether it is pressed to the first or second position. Press this button to seek to the next or previous selection on the compact disc.

SCAN: Press this button. You will hear the first few seconds of the first track on each disc. Press this button again to stop scanning. (This button is available on the AM-FM Stereo with Cassette Tape Player only.)

TRACK SCAN: Press SCAN for less than two seconds. You will hear the first few seconds of each track on a disc. Press SCAN again to stop TRACK SCAN. The CD will mute while scanning and SCAN will appear on the display. (This function is not available on the AM-FM Stereo with Cassette Tape Player.)

DISC SCAN: Press SCAN for more than two seconds. You will hear the first few seconds of the first track on each disc. Press SCAN again to stop DISC SCAN. The CD will mute while scanning and SCAN will appear on the display. (This function is not available on the AM-FM Stereo with Cassette Tape Player.)

RDM: Press this button to hear the tracks in random, rather than sequential, order. RANDOM will appear on the display. Press TUNE-SEEK while RDM is on the display to randomly seek through discs. Press RDM again to turn off random play. (This button is not available on the AM-FM Stereo with Cassette Tape Player.)

SIDE: Press this button to select the next disc in the changer. If your vehicle is equipped with the AM-FM Stereo with Cassette Tape Player, CD and the disc number will appear on the display each time you press this button. If your vehicle is equipped with any other audio system, DISC LOADING will appear on the display and the disc number on the radio display will go to that of the next available CD each time you press this button.

SOURCE: Press this button to select a source. The audio source must be loaded to play. If none of the audio sources are loaded, NO SOURCE LOADED will appear on the display. Press this button again or press BAND to switch back to the radio. (CD will be displayed for a few seconds instead on the AM-FM Stereo with Cassette Tape Player, then the radio will play.)

EJECT: Slide the CD changer door all the way open and the disc holder will automatically eject.

Compact Disc Changer Errors

CD CHANGER ERROR could be displayed for the following:

- The road is too rough. The disc should play when the road is smoother.
- The disc is dirty, scratched, wet or loaded label side up.
- The air is very humid. If so, wait about an hour and try again.

CD CHANGER DOOR OPEN is displayed when the CD changer door is left open. (CHEK DOOR will be displayed instead on the AM-FM Stereo with Cassette Tape Player.) Completely close the changer door to restore normal operation.

If any error occurs repeatedly or if an error cannot be corrected, please contact your dealer.

Theft-Deterrent Feature

THEFTLOCK[®] is designed to discourage theft of your radio. Your vehicle has a “built-in” theft-deterrent feature on each radio that is automatic -- there is no programming required. The radio in your vehicle cannot be used in any other vehicle. When the radio was originally installed in your vehicle at the factory, it stored the Vehicle Identification Number (VIN). Each time the ignition is turned on, the VIN is verified. If the vehicle’s VIN does not match the VIN stored in the radio, THEFTLOCK will be activated and the audio system will not play. If the radio is removed from your vehicle, the original VIN in the radio can be used to trace the radio back to your vehicle.

Audio Steering Wheel Controls



Some audio controls can be adjusted at the steering wheel. They include the following:

- ▶ : Press this button to move forward through preset radio stations or to the next selection on a tape or CD.
- ◀ : Press this button to move rearward through preset radio stations or to the previous selection on a tape or CD.

↑ **(BAND):** Press this button to change between AM, FM1 or FM2 for the radio. This button also changes a tape to the other side, restarts a CD if playing a single CD or goes to the next available CD loaded in the trunk-mounted CD changer.

+ : Pressing this button increases volume.

- : Pressing this button decreases volume.

o **(SOURCE):** To change to a tape or CD, press this button.

Understanding Radio Reception

AM

The range for most AM stations is greater than for FM, especially at night. The longer range, however, can cause stations to interfere with each other. AM can pick up noise from things like storms and power lines. Try reducing the treble to reduce this noise if you ever get it.

FM Stereo

FM stereo will give you the best sound, but FM signals will reach only about 10 to 40 miles (16 to 65 km). Tall buildings or hills can interfere with FM signals, causing the sound to come and go.

Weather Band (If Equipped)

Weather band is restricted to speech and the audio quality is not as good as with the AM or FM bands. Depending on location, the radio should receive one or two channels.

Tips About Your Audio System

Hearing damage from loud noise is almost undetectable until it is too late. Your hearing can adapt to higher volumes of sound. Sound that seems normal can be loud and harmful to your hearing. Take precautions by adjusting the volume control on your radio to a safe sound level before your hearing adapts to it.

To help avoid hearing loss or damage:

- Adjust the volume control to the lowest setting.
- Increase volume slowly until you hear comfortably and clearly.

NOTICE:

Before you add any sound equipment to your vehicle -- like a tape player, CB radio, mobile telephone or two-way radio -- be sure you can add what you want. If you can, it's very important to do it properly. Added sound equipment may interfere with the operation of your vehicle's engine, radio or other systems, and even damage them. Your vehicle's systems may also interfere with the operation of sound equipment that has been added improperly.

So, before adding sound equipment, check with your dealer and be sure to check Federal rules covering mobile radio and telephone units.

Care of Your Cassette Tape Player

A tape player that is not cleaned regularly can cause reduced sound quality, ruined cassettes or a damaged mechanism. Cassette tapes should be stored in their cases away from contaminants, direct sunlight and extreme heat. If they aren't, they may not operate properly or may cause failure of the tape player.

Your tape player should be cleaned regularly after every 50 hours of use. Your radio may display CLN or CLEAN TAPE to indicate that you have used your tape player for 50 hours without resetting the tape clean timer. If this message appears on the display, your cassette tape player needs to be cleaned. It will still play tapes, but you should clean it as soon as possible to prevent damage to your tapes and player. If you notice a reduction in sound quality, try a known good cassette to see if it is the tape or the tape player at fault. If this other cassette has no improvement in sound quality, clean the tape player.

The recommended cleaning method for your cassette tape player is the use of a scrubbing action, non-abrasive cleaning cassette with pads which scrub the tape head as the hubs of the cleaner cassette turn. The recommended cleaning cassette is available through your dealership (GM Part No. 12344789).

When using a scrubbing action, non-abrasive cleaning cassette, it is normal for the cassette to eject because your unit is equipped with a cut tape detection feature and a cleaning cassette may appear as a broken tape. To prevent the cleaning cassette from being ejected, use the following steps.

1. Turn the ignition to ON (II).
2. Turn the radio off.
3. Press and hold the SOURCE button for two seconds. The tape symbol on the display will flash three times.
4. Turn the radio on and insert the scrubbing action cleaning cassette.
5. Eject the cleaning cassette after the manufacturer's recommended cleaning time.

When the cleaning cassette has been ejected, the cut tape detection feature is active again.

You may also choose a non-scrubbing action, wet-type cleaner which uses a cassette with a fabric belt to clean the tape head. This type of cleaning cassette will not eject on its own. A non-scrubbing action cleaner may not clean as thoroughly as the scrubbing type cleaner. The use of a non-scrubbing action, dry-type cleaning cassette is not recommended.

If your vehicle is equipped with the AM-FM Stereo with Cassette Tape Player, press and hold the eject button for five seconds to reset the CLN indicator after you clean the player. The radio will display --- to show the indicator was reset.

If your vehicle is equipped with the AM-FM Stereo with Cassette Tape and Compact Disc Player with Radio Data Systems (RDS), press and hold the eject button for three seconds to reset the CLEAN TAPE indicator after you clean the player. The radio will display CLEAN TAPE MSG CLEARED to show the indicator was reset.

Cassettes are subject to wear and the sound quality may degrade over time. Always make sure the cassette tape is in good condition before you have your tape player serviced.

Care of Your Compact Discs

Handle discs carefully. Store them in their original cases or other protective cases and away from direct sunlight and dust. If the surface of a disc is soiled, dampen a clean, soft cloth in a mild, neutral detergent solution and clean it, wiping from the center to the edge.

Be sure never to touch the signal surface when handling discs. Pick up discs by grasping the outer edges or the edge of the hole and the outer edge.

Care of Your Compact Disc Player

The use of CD lens cleaner discs is not advised, due to the risk of contaminating the lens of the CD optics with lubricants internal to the CD mechanism.

Heated Backlite Antenna

Your AM-FM antenna is integrated with your rear window defogger, located in the rear window. Be sure that the inside surface of the rear window is not scratched and that the lines on the glass are not damaged. If the inside surface is damaged, it could interfere with radio reception.

NOTICE:

Do not try to clear frost or other material from the inside of the rear window with a razor blade or anything else that is sharp. This may damage the rear defogger grid and affect your radio's ability to pick up stations clearly. The repairs wouldn't be covered by your warranty.

If, when you turn on your rear window defogger, you hear static on your radio station, it could mean that a defogger grid line has been damaged. If this is true, the grid line must be repaired.

If you choose to add a cellular telephone to your vehicle, and the antenna needs to be attached to the glass, be sure that you do not damage the grid lines for the AM-FM antenna. Be sure the antenna does not touch a grid line.



Section 4 Your Driving and the Road

Here you'll find information about driving on different kinds of roads and in varying weather conditions. We've also included many other useful tips on driving.

4-2	Defensive Driving	4-17	Driving in Rain and on Wet Roads
4-3	Drunken Driving	4-19	City Driving
4-6	Control of a Vehicle	4-20	Freeway Driving
4-6	Braking	4-21	Before Leaving on a Long Trip
4-7	Anti-Lock Brakes (ABS)	4-22	Highway Hypnosis
4-10	Steering	4-23	Hill and Mountain Roads
4-12	Off-Road Recovery	4-24	Winter Driving
4-13	Passing	4-28	Recreational Vehicle Towing
4-14	Loss of Control	4-29	Loading Your Vehicle
4-15	Driving at Night	4-31	Towing a Trailer



Defensive Driving

The best advice anyone can give about driving is:
Drive defensively.

Please start with a very important safety device in your vehicle: Buckle up. (See “Safety Belts” in the Index.)

Defensive driving really means “be ready for anything.” On city streets, rural roads or freeways, it means “always expect the unexpected.”

Assume that pedestrians or other drivers are going to be careless and make mistakes. Anticipate what they might do. Be ready for their mistakes.

Rear-end collisions are about the most preventable of accidents. Yet they are common. Allow enough following distance. It’s the best defensive driving maneuver, in both city and rural driving. You never know when the vehicle in front of you is going to brake or turn suddenly.

Defensive driving requires that a driver concentrate on the driving task. Anything that distracts from the driving task -- such as concentrating on a cellular telephone call, reading, or reaching for something on the floor -- makes proper defensive driving more difficult and can even cause a collision, with resulting injury. Ask a passenger to help do things like this, or pull off the road in a safe place to do them yourself. These simple defensive driving techniques could save your life.

Drunken Driving

Death and injury associated with drinking and driving is a national tragedy. It's the number one contributor to the highway death toll, claiming thousands of victims every year.

Alcohol affects four things that anyone needs to drive a vehicle:

- Judgment
- Muscular Coordination
- Vision
- Attentiveness.

Police records show that almost half of all motor vehicle-related deaths involve alcohol. In most cases, these deaths are the result of someone who was drinking and driving. In recent years, over 17,000 annual motor vehicle-related deaths have been associated with the use of alcohol, with more than 300,000 people injured.

Many adults -- by some estimates, nearly half the adult population -- choose never to drink alcohol, so they never drive after drinking. For persons under 21, it's against the law in every U.S. state to drink alcohol. There are good medical, psychological and developmental reasons for these laws.

The obvious way to solve the leading highway safety problem is for people never to drink alcohol and then drive. But what if people do? How much is "too much" if the driver plans to drive? It's a lot less than many might think. Although it depends on each person and situation, here is some general information on the problem.

The Blood Alcohol Concentration (BAC) of someone who is drinking depends upon four things:

- The amount of alcohol consumed
- The drinker's body weight
- The amount of food that is consumed before and during drinking
- The length of time it has taken the drinker to consume the alcohol.

According to the American Medical Association, a 180-lb. (82 kg) person who drinks three 12-ounce (355 ml) bottles of beer in an hour will end up with a BAC of about 0.06 percent. The person would reach the same BAC by drinking three 4-ounce (120 ml) glasses of wine or three mixed drinks if each had 1-1/2 ounces (45 ml) of a liquor like whiskey, gin or vodka.



It's the amount of alcohol that counts. For example, if the same person drank three double martinis (3 ounces or 90 ml of liquor each) within an hour, the person's BAC would be close to 0.12 percent. A person who consumes food just before or during drinking will have a somewhat lower BAC level.

There is a gender difference, too. Women generally have a lower relative percentage of body water than men.

Since alcohol is carried in body water, this means that a woman generally will reach a higher BAC level than a man of her same body weight when each has the same number of drinks.

The law in many U.S. states sets the legal limit at a BAC of 0.10 percent. In a growing number of U.S. states, and throughout Canada, the limit is 0.08 percent. In some other countries, it's even lower. The BAC limit for all commercial drivers in the United States is 0.04 percent.

The BAC will be over 0.10 percent after three to six drinks (in one hour). Of course, as we've seen, it depends on how much alcohol is in the drinks, and how quickly the person drinks them.

But the ability to drive is affected well below a BAC of 0.10 percent. Research shows that the driving skills of many people are impaired at a BAC approaching 0.05 percent, and that the effects are worse at night. All drivers are impaired at BAC levels above 0.05 percent. Statistics show that the chance of being in a collision increases sharply for drivers who have a BAC of 0.05 percent or above. A driver with a BAC level of 0.06 percent has doubled his or her chance of having a collision. At a BAC level of 0.10 percent, the chance of this driver having a collision is 12 times greater; at a level of 0.15 percent, the chance is 25 times greater!

The body takes about an hour to rid itself of the alcohol in one drink. No amount of coffee or number of cold showers will speed that up. “I’ll be careful” isn’t the right answer. What if there’s an emergency, a need to take sudden action, as when a child darts into the street? A person with even a moderate BAC might not be able to react quickly enough to avoid the collision.

There’s something else about drinking and driving that many people don’t know. Medical research shows that alcohol in a person’s system can make crash injuries worse, especially injuries to the brain, spinal cord or heart. This means that when anyone who has been drinking -- driver or passenger -- is in a crash, that person’s chance of being killed or permanently disabled is higher than if the person had not been drinking.

 **CAUTION:**

Drinking and then driving is very dangerous. Your reflexes, perceptions, attentiveness and judgment can be affected by even a small amount of alcohol. You can have a serious -- or even fatal -- collision if you drive after drinking. Please don’t drink and drive or ride with a driver who has been drinking. Ride home in a cab; or if you’re with a group, designate a driver who will not drink.

Control of a Vehicle

You have three systems that make your vehicle go where you want it to go. They are the brakes, the steering and the accelerator. All three systems have to do their work at the places where the tires meet the road.

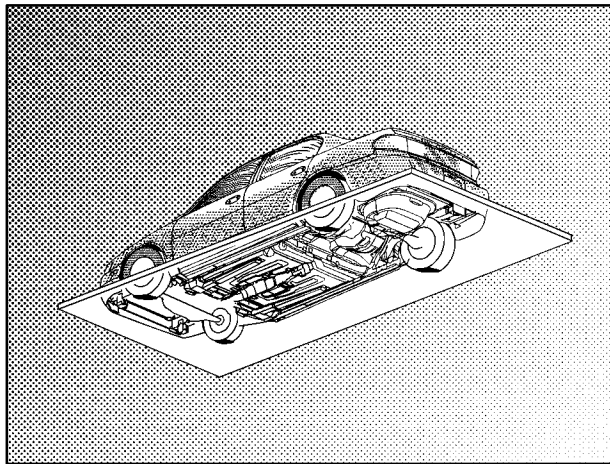

Sometimes, as when you're driving on snow or ice, it's easy to ask more of those control systems than the tires and road can provide. That means you can lose control of your vehicle.

Braking

Braking action involves *perception time* and *reaction time*.

First, you have to decide to push on the brake pedal. That's *perception time*. Then you have to bring up your foot and do it. That's *reaction time*.

Average *reaction time* is about $\frac{3}{4}$ of a second. But that's only an average. It might be less with one driver and as long as two or three seconds or more with another. Age, physical condition, alertness, coordination and eyesight all play a part. So do alcohol, drugs and frustration. But even in $\frac{3}{4}$ of a second, a vehicle moving at 60 mph (100 km/h) travels 66 feet (20 m). That could be a lot of distance in an emergency, so keeping enough space between your vehicle and others is important.

And, of course, actual stopping distances vary greatly with the surface of the road (whether it's pavement or gravel); the condition of the road (wet, dry, icy); tire tread; the condition of your brakes; the weight of the vehicle and the amount of brake force applied.

Avoid needless heavy braking. Some people drive in spurts -- heavy acceleration followed by heavy braking -- rather than keeping pace with traffic. This is a mistake. Your brakes may not have time to cool between hard stops. Your brakes will wear out much faster if you do a lot of heavy braking. If you keep pace with the traffic and allow realistic following distances, you will eliminate a lot of unnecessary braking. That means better braking and longer brake life.

If your engine ever stops while you're driving, brake normally but don't pump your brakes. If you do, the pedal may get harder to push down. If your engine stops, you will still have some power brake assist. But you will use it when you brake. Once the power assist is used up, it may take longer to stop and the brake pedal will be harder to push.

Anti-Lock Brakes (ABS)

Your vehicle has anti-lock brakes (ABS). ABS is an advanced electronic braking system that will help prevent a braking skid.

When you start your engine and begin to drive away, your anti-lock brake system will check itself. You may hear a momentary motor or clicking noise while this test is going on, and you may even notice that your brake pedal moves a little. This is normal.

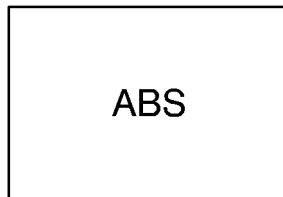

If there's a problem with the anti-lock brake system, this warning light will stay on. See "Anti-Lock Brake System Warning Light" in the Index.



Here's how anti-lock works. Let's say the road is wet. You're driving safely. Suddenly an animal jumps out in front of you.

You slam on the brakes. Here's what happens with ABS.

A computer senses that wheels are slowing down. If one of the wheels is about to stop rolling, the computer will separately work the brakes at each wheel.

The anti-lock system can change the brake pressure faster than any driver could. The computer is programmed to make the most of available tire and road conditions.



You can steer around the obstacle while braking hard.

As you brake, your computer keeps receiving updates on wheel speed and controls braking pressure accordingly.

Remember: Anti-lock doesn't change the time you need to get your foot up to the brake pedal or always decrease stopping distance. If you get too close to the vehicle in front of you, you won't have time to apply your brakes if that vehicle suddenly slows or stops. Always leave enough room up ahead to stop, even though you have anti-lock brakes.

Using Anti-Lock

Don't pump the brakes. Just hold the brake pedal down firmly and let anti-lock work for you. You may hear the anti-lock pump or motor operate, and feel the brake pedal pulsate, but this is normal.

Traction Control System

Your vehicle has a traction control system that limits wheel spin. This is especially useful in slippery road conditions. The system operates only if it senses that one or both of the rear wheels are spinning or beginning to lose traction. When this happens, the system brakes the spinning wheel and/or reduces engine power to limit wheel spin.

You may feel or hear the system working, but this is normal.

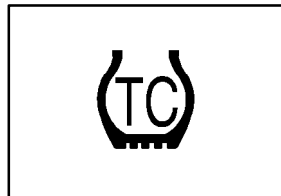

This warning light will come on to let you know if there's a problem with your traction control system.

See “Traction Control System Warning Light” in the Index. When this warning light is on, the system will not limit wheel spin. Adjust your driving accordingly.

The traction control system automatically comes on whenever you start your vehicle. To limit wheel spin, especially in slippery road conditions, you should always leave the system on. But you can turn the traction control system off if you ever need to. (You should turn the system off if your vehicle ever gets stuck in sand, mud, ice or snow. See “Rocking Your Vehicle” in the Index.)



To turn the system off, press the TCS OFF button located next to the radio on the center console.

Braking in Emergencies

With anti-lock, you can steer and brake at the same time. In many emergencies, steering can help you more than even the very best braking.

Steering

Power Steering

If you lose power steering assist because the engine stops or the system is not functioning, you can steer but it will take much more effort.

Speed Sensitive Steering (SSS)

This system varies the amount of steering effort in relation to your vehicle speed. Steering is easier at a lower speed for maneuvering and parking ease. As your vehicle speed increases, the steering effort also increases. At highway speeds, the amount of steering effort is increased to provide manual-like steering for maximum control and stability. If your vehicle seems harder to steer than normal when parking or driving slow, something may be wrong with the speed sensitive steering system. You will still have power steering, however, steering will be stiffer than normal at low speeds.

Steering Tips

Driving on Curves

It's important to take curves at a reasonable speed.

A lot of the "driver lost control" accidents mentioned on the news happen on curves. Here's why:

Experienced driver or beginner, each of us is subject to the same laws of physics when driving on curves. The traction of the tires against the road surface makes it possible for the vehicle to change its path when you turn the front wheels. If there's no traction, inertia will keep the vehicle going in the same direction. If you've ever tried to steer a vehicle on wet ice, you'll understand this.

The traction you can get in a curve depends on the condition of your tires and the road surface, the angle at which the curve is banked, and your speed. While you're in a curve, speed is the one factor you can control.

Suppose you're steering through a sharp curve. Then you suddenly accelerate. Both control systems -- steering and acceleration -- have to do their work where the tires meet the road. Adding the sudden acceleration can demand too much of those places. You can lose control. Refer to "Traction Control System" in the Index.

What should you do if this ever happens? Ease up on the accelerator pedal, steer the vehicle the way you want it to go, and slow down.

Speed limit signs near curves warn that you should adjust your speed. Of course, the posted speeds are based on good weather and road conditions. Under less favorable conditions you'll want to go slower.

If you need to reduce your speed as you approach a curve, do it before you enter the curve, while your front wheels are straight ahead.

Try to adjust your speed so you can "drive" through the curve. Maintain a reasonable, steady speed. Wait to accelerate until you are out of the curve, and then accelerate gently into the straightaway.

Steering in Emergencies

There are times when steering can be more effective than braking. For example, you come over a hill and find a truck stopped in your lane, or a car suddenly pulls out from nowhere, or a child darts out from between parked cars and stops right in front of you. You can avoid these problems by braking -- if you can stop in time. But sometimes you can't; there isn't room. That's the time for evasive action -- steering around the problem.

Your vehicle can perform very well in emergencies like these. First apply your brakes. (See "Braking in Emergencies" earlier in this section.) It is better to remove as much speed as you can from a possible collision. Then steer around the problem, to the left or right depending on the space available.

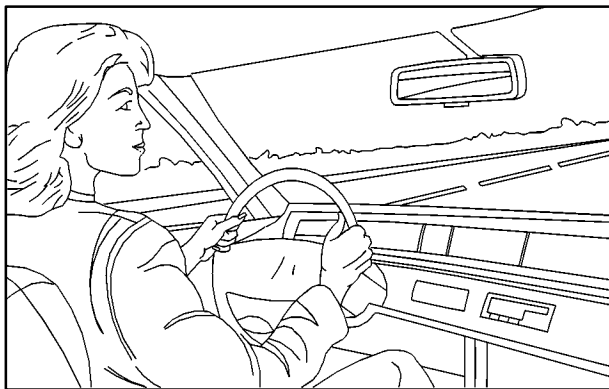

An emergency like this requires close attention and a quick decision. If you are holding the steering wheel at the recommended 9 and 3 o'clock positions, you can turn it a full 180 degrees very quickly without removing either hand. But you have to act fast, steer quickly, and just as quickly straighten the wheel once you have avoided the object.

The fact that such emergency situations are always possible is a good reason to practice defensive driving at all times and wear safety belts properly.

Off-Road Recovery

You may find that your right wheels have dropped off the edge of a road onto the shoulder while you're driving.

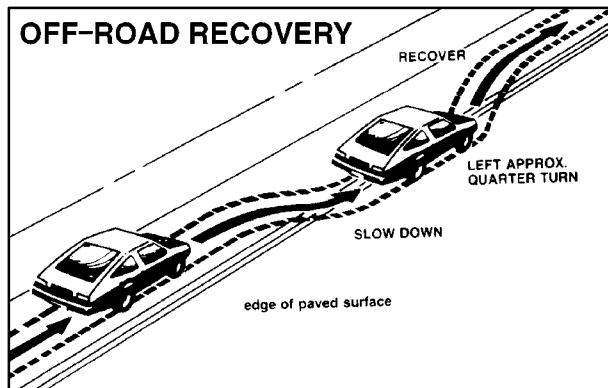

If the level of the shoulder is only slightly below the pavement, recovery should be fairly easy. Ease off the accelerator and then, if there is nothing in the way, steer so that your vehicle straddles the edge of the pavement. You can turn the steering wheel up to one-quarter turn until the right front tire contacts the pavement edge. Then turn your steering wheel to go straight down the roadway.

Passing

The driver of a vehicle about to pass another on a two-lane highway waits for just the right moment, accelerates, moves around the vehicle ahead, then goes back into the right lane again. A simple maneuver?

Not necessarily! Passing another vehicle on a two-lane highway is a potentially dangerous move, since the passing vehicle occupies the same lane as oncoming traffic for several seconds. A miscalculation, an error in judgment, or a brief surrender to frustration or anger can suddenly put the passing driver face to face with the worst of all traffic accidents -- the head-on collision.

So here are some tips for passing:

- “Drive ahead.” Look down the road, to the sides and to crossroads for situations that might affect your passing patterns. If you have any doubt whatsoever about making a successful pass, wait for a better time.
- Watch for traffic signs, pavement markings and lines. If you can see a sign up ahead that might indicate a turn or an intersection, delay your pass. A broken center line usually indicates it’s all right to pass (providing the road ahead is clear). Never cross a solid line on your side of the lane or a double solid line, even if the road seems empty of approaching traffic.
- Do not get too close to the vehicle you want to pass while you’re awaiting an opportunity. For one thing, following too closely reduces your area of vision, especially if you’re following a larger vehicle. Also, you won’t have adequate space if the vehicle ahead suddenly slows or stops. Keep back a reasonable distance.
- When it looks like a chance to pass is coming up, start to accelerate but stay in the right lane and don’t get too close. Time your move so you will be increasing speed as the time comes to move into the other lane. If the way is clear to pass, you will have a “running start” that more than makes up for the distance you would lose by dropping back. And if something happens to cause you to cancel your pass, you need only slow down and drop back again and wait for another opportunity.
- If other cars are lined up to pass a slow vehicle, wait your turn. But take care that someone isn’t trying to pass you as you pull out to pass the slow vehicle. Remember to glance over your shoulder and check the blind spot.

- Check your mirrors, glance over your shoulder, and start your left lane change signal before moving out of the right lane to pass. When you are far enough ahead of the passed vehicle to see its front in your inside mirror, activate your right lane change signal and move back into the right lane. (Remember that your right outside mirror is convex. The vehicle you just passed may seem to be farther away from you than it really is.)
- Try not to pass more than one vehicle at a time on two-lane roads. Reconsider before passing the next vehicle.
- Don't overtake a slowly moving vehicle too rapidly. Even though the brake lamps are not flashing, it may be slowing down or starting to turn.
- If you're being passed, make it easy for the following driver to get ahead of you. Perhaps you can ease a little to the right.

Loss of Control

Let's review what driving experts say about what happens when the three control systems (brakes, steering and acceleration) don't have enough friction where the tires meet the road to do what the driver has asked.

In any emergency, don't give up. Keep trying to steer and constantly seek an escape route or area of less danger.

Skidding

In a skid, a driver can lose control of the vehicle. Defensive drivers avoid most skids by taking reasonable care suited to existing conditions, and by not "overdriving" those conditions. But skids are always possible.

The three types of skids correspond to your vehicle's three control systems. In the braking skid, your wheels aren't rolling. In the steering or cornering skid, too much speed or steering in a curve causes tires to slip and lose cornering force. And in the acceleration skid, too much throttle causes the driving wheels to spin.

A cornering skid is best handled by easing your foot off the accelerator pedal.

Remember: Any traction control system helps avoid only the acceleration skid.

If your traction control system is off, then an acceleration skid is also best handled by easing your foot off the accelerator pedal.

If your vehicle starts to slide, ease your foot off the accelerator pedal and quickly steer the way you want the vehicle to go. If you start steering quickly enough, your vehicle may straighten out. Always be ready for a second skid if it occurs.

Of course, traction is reduced when water, snow, ice, gravel or other material is on the road. For safety, you'll want to slow down and adjust your driving to these conditions. It is important to slow down on slippery surfaces because stopping distance will be longer and vehicle control more limited.

While driving on a surface with reduced traction, try your best to avoid sudden steering, acceleration or braking (including engine braking by shifting to a lower gear). Any sudden changes could cause the tires to slide. You may not realize the surface is slippery until your vehicle is skidding. Learn to recognize warning clues -- such as enough water, ice or packed snow on the road to make a "mirrored surface" -- and slow down when you have any doubt.

Remember: Any anti-lock brake system (ABS) helps avoid only the braking skid.

Driving at Night

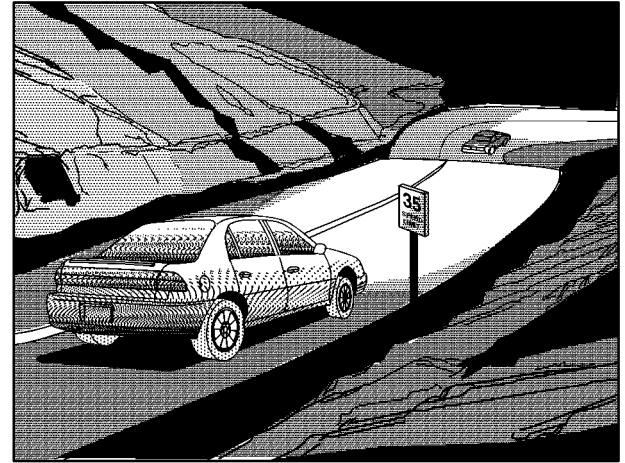

Night driving is more dangerous than day driving. One reason is that some drivers are likely to be impaired -- by alcohol or drugs, with night vision problems, or by fatigue.

Here are some tips on night driving.

- Drive defensively.
- Don't drink and drive.
- Since you can't see as well, you may need to slow down and keep more space between you and other vehicles.
- Slow down, especially on higher speed roads. Your headlamps can light up only so much road ahead.
- In remote areas, watch for animals.
- If you're tired, pull off the road in a safe place and rest.

Night Vision

No one can see as well at night as in the daytime. But as we get older these differences increase. A 50-year-old driver may require at least twice as much light to see the same thing at night as a 20-year-old.

What you do in the daytime can also affect your night vision. For example, if you spend the day in bright sunshine you are wise to wear sunglasses. Your eyes will have less trouble adjusting to night. But if you're driving, don't wear sunglasses at night. They may cut down on glare from headlamps, but they also make a lot of things invisible.

You can be temporarily blinded by approaching headlamps. It can take a second or two, or even several seconds, for your eyes to readjust to the dark. When you are faced with severe glare (as from a driver who doesn't lower the high beams, or a vehicle with misaimed headlamps), slow down a little. Avoid staring directly into the approaching headlamps.

Keep your windshield and all the glass on your vehicle clean -- inside and out. Glare at night is made much worse by dirt on the glass. Even the inside of the glass can build up a film caused by dust. Dirty glass makes lights dazzle and flash more than clean glass would, making the pupils of your eyes contract repeatedly.

Remember that your headlamps light up far less of a roadway when you are in a turn or curve. Keep your eyes moving; that way, it's easier to pick out dimly lighted objects. Just as your headlamps should be checked regularly for proper aim, so should your eyes be examined regularly. Some drivers suffer from night blindness -- the inability to see in dim light -- and aren't even aware of it.

Driving in Rain and on Wet Roads

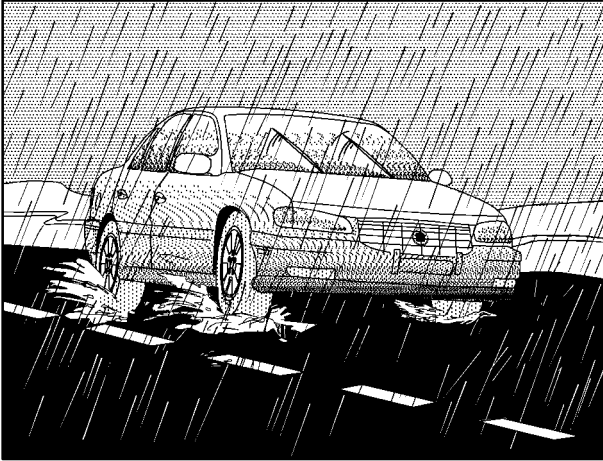

Rain and wet roads can mean driving trouble. On a wet road, you can't stop, accelerate or turn as well because your tire-to-road traction isn't as good as on dry roads. And, if your tires don't have much tread left, you'll get even less traction. It's always wise to go slower and be cautious if rain starts to fall while you are driving. The surface may get wet suddenly when your reflexes are tuned for driving on dry pavement.

The heavier the rain, the harder it is to see. Even if your windshield wiper blades are in good shape, a heavy rain can make it harder to see road signs and traffic signals, pavement markings, the edge of the road and even people walking.

It's wise to keep your windshield wiping equipment in good shape and keep your windshield washer tank filled with washer fluid. Replace your windshield wiper inserts when they show signs of streaking or missing areas on the windshield, or when strips of rubber start to separate from the inserts.

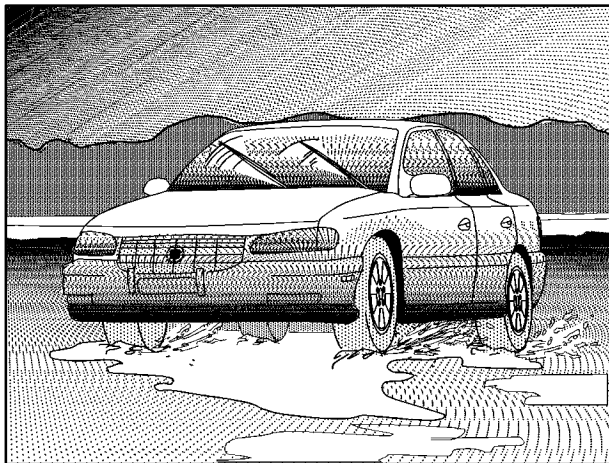

Driving too fast through large water puddles or even going through some car washes can cause problems, too. The water may affect your brakes. Try to avoid puddles. But if you can't, try to slow down before you hit them.

⚠ CAUTION:

Wet brakes can cause accidents. They won't work as well in a quick stop and may cause pulling to one side. You could lose control of the vehicle.

After driving through a large puddle of water or a car wash, apply your brake pedal lightly until your brakes work normally.

Hydroplaning

Hydroplaning is dangerous. So much water can build up under your tires that they can actually ride on the water. This can happen if the road is wet enough and you're going fast enough. When your vehicle is hydroplaning, it has little or no contact with the road.

Hydroplaning doesn't happen often. But it can if your tires do not have much tread or if the pressure in one or more is low. It can happen if a lot of water is standing on the road. If you can see reflections from trees, telephone poles or other vehicles, and raindrops "dimple" the water's surface, there could be hydroplaning.

Hydroplaning usually happens at higher speeds. There just isn't a hard and fast rule about hydroplaning. The best advice is to slow down when it is raining.

Driving Through Deep Standing Water

NOTICE:

If you drive too quickly through deep puddles or standing water, water can come in through your engine's air intake and badly damage your engine. Never drive through water that is slightly lower than the underbody of your vehicle. If you can't avoid deep puddles or standing water, drive through them very slowly.

Some Other Rainy Weather Tips

- Besides slowing down, allow some extra following distance. And be especially careful when you pass another vehicle. Allow yourself more clear room ahead, and be prepared to have your view restricted by road spray.
- Have good tires with proper tread depth. (See "Tires" in the Index.)

City Driving



One of the biggest problems with city streets is the amount of traffic on them. You'll want to watch out for what the other drivers are doing and pay attention to traffic signals.

Here are ways to increase your safety in city driving:

- Know the best way to get to where you are going. Get a city map and plan your trip into an unknown part of the city just as you would for a cross-country trip.
- Try to use the freeways that rim and crisscross most large cities. You'll save time and energy. (See the next part, "Freeway Driving.")
- Treat a green light as a warning signal. A traffic light is there because the corner is busy enough to need it. When a light turns green, and just before you start to move, check both ways for vehicles that have not cleared the intersection or may be running the red light.

Freeway Driving



Mile for mile, freeways (also called thruways, parkways, expressways, turnpikes or superhighways) are the safest of all roads. But they have their own special rules.

The most important advice on freeway driving is: Keep up with traffic and keep to the right. Drive at the same speed most of the other drivers are driving. Too-fast or too-slow driving breaks a smooth traffic flow. Treat the left lane on a freeway as a passing lane.

At the entrance, there is usually a ramp that leads to the freeway. If you have a clear view of the freeway as you drive along the entrance ramp, you should begin to check traffic. Try to determine where you expect to blend with the flow. Try to merge into the gap at close to the prevailing speed. Switch on your turn signal, check your mirrors and glance over your shoulder as often as necessary. Try to blend smoothly with the traffic flow.

Once you are on the freeway, adjust your speed to the posted limit or to the prevailing rate if it's slower. Stay in the right lane unless you want to pass.

Before changing lanes, check your mirrors. Then use your turn signal.

Just before you leave the lane, glance quickly over your shoulder to make sure there isn't another vehicle in your "blind" spot.

Once you are moving on the freeway, make certain you allow a reasonable following distance. Expect to move slightly slower at night.

When you want to leave the freeway, move to the proper lane well in advance. If you miss your exit, do not, under any circumstances, stop and back up. Drive on to the next exit.

The exit ramp can be curved, sometimes quite sharply. The exit speed is usually posted.

Reduce your speed according to your speedometer, not to your sense of motion. After driving for any distance at higher speeds, you may tend to think you are going slower than you actually are.

Before Leaving on a Long Trip

Make sure you're ready. Try to be well rested. If you must start when you're not fresh -- such as after a day's work -- don't plan to make too many miles that first part of the journey. Wear comfortable clothing and shoes you can easily drive in.

Is your vehicle ready for a long trip? If you keep it serviced and maintained, it's ready to go. If it needs service, have it done before starting out. Of course, you'll find experienced and able service experts in Catera dealerships all across North America. They'll be ready and willing to help if you need it.

Here are some things you can check before a trip:

- *Windshield Washer Fluid*: Is the reservoir full? Are all windows clean inside and outside?
- *Wiper Blades*: Are they in good shape?
- *Fuel, Engine Oil, Other Fluids*: Have you checked all levels?
- *Lamps*: Are they all working? Are the lenses clean?
- *Tires*: They are vitally important to a safe, trouble-free trip. Is the tread good enough for long-distance driving? Are the tires all inflated to the recommended pressure?
- *Weather Forecasts*: What's the weather outlook along your route? Should you delay your trip a short time to avoid a major storm system?
- *Maps*: Do you have up-to-date maps?

Highway Hypnosis

Is there actually such a condition as “highway hypnosis”? Or is it just plain falling asleep at the wheel? Call it highway hypnosis, lack of awareness, or whatever.

There is something about an easy stretch of road with the same scenery, along with the hum of the tires on the road, the drone of the engine, and the rush of the wind against the vehicle that can make you sleepy. Don't let it happen to you! If it does, your vehicle can leave the road in *less than a second*, and you could crash and be injured.

What can you do about highway hypnosis? First, be aware that it can happen.

Then here are some tips:

- Make sure your vehicle is well ventilated, with a comfortably cool interior.
- Keep your eyes moving. Scan the road ahead and to the sides. Check your rearview mirrors and your instruments frequently.
- If you get sleepy, pull off the road into a rest, service or parking area and take a nap, get some exercise, or both. For safety, treat drowsiness on the highway as an emergency.

Hill and Mountain Roads



Driving on steep hills or mountains is different from driving in flat or rolling terrain.

If you drive regularly in steep country, or if you're planning to visit there, here are some tips that can make your trips safer and more enjoyable.

- Keep your vehicle in good shape. Check all fluid levels and also the brakes, tires, cooling system and transmission. These parts can work hard on mountain roads.
- Know how to go down hills. The most important thing to know is this: let your engine do some of the slowing down. Shift to a lower gear when you go down a steep or long hill.

CAUTION:

If you don't shift down, your brakes could get so hot that they wouldn't work well. You would then have poor braking or even none going down a hill. You could crash. Shift down to let your engine assist your brakes on a steep downhill slope.

CAUTION:

Coasting downhill in NEUTRAL (N) or with the ignition off is dangerous. Your brakes will have to do all the work of slowing down. They could get so hot that they wouldn't work well. You would then have poor braking or even none going down a hill. You could crash. Always have your engine running and your vehicle in gear when you go downhill.

- Know how to go uphill. You may want to shift down to a lower gear. The lower gears help cool your engine and transmission, and you can climb the hill better.
- Stay in your own lane when driving on two-lane roads in hills or mountains. Don't swing wide or cut across the center of the road. Drive at speeds that let you stay in your own lane.
- As you go over the top of a hill, be alert. There could be something in your lane, like a stalled car or an accident.
- You may see highway signs on mountains that warn of special problems. Examples are long grades, passing or no-passing zones, a falling rocks area or winding roads. Be alert to these and take appropriate action.

Winter Driving



Here are some tips for winter driving:

- Have your vehicle in good shape for winter.
- You may want to put winter emergency supplies in your trunk.



Include an ice scraper, a small brush or broom, a supply of windshield washer fluid, a rag, some winter outer clothing, a small shovel, a flashlight, a red cloth and a couple of reflective warning triangles. And, if you will be driving under severe conditions, include a small bag of sand, a piece of old carpet or a couple of burlap bags to help provide traction. Be sure you properly secure these items in your vehicle.

Driving on Snow or Ice

Most of the time, those places where your tires meet the road probably have good traction.

However, if there is snow or ice between your tires and the road, you can have a very slippery situation. You'll have a lot less traction or "grip" and will need to be very careful.

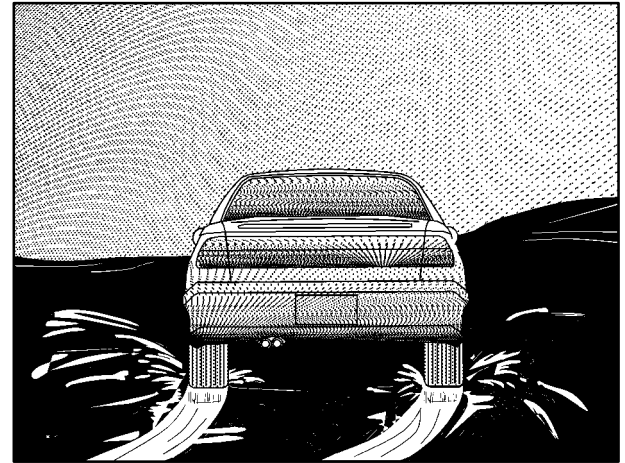

What's the worst time for this? "Wet ice." Very cold snow or ice can be slick and hard to drive on. But wet ice can be even more trouble because it may offer the least traction of all. You can get wet ice when it's about freezing (32°F; 0°C) and freezing rain begins to fall. Try to avoid driving on wet ice until salt and sand crews can get there.

Whatever the condition -- smooth ice, packed, blowing or loose snow -- drive with caution.

Keep your traction control system on. It improves your ability to accelerate when driving on a slippery road. Even though your vehicle has a traction control system, you'll want to slow down and adjust your driving to the road conditions. See "Traction Control System" in the Index. Also, see "Third Gear Start" in the Index.

Your anti-lock brakes improve your vehicle's stability when you make a hard stop on a slippery road. Even though you have the anti-lock braking system, you'll want to begin stopping sooner than you would on dry pavement. See "Anti-Lock" in the Index.

- Allow greater following distance on any slippery road.
- Watch for slippery spots. The road might be fine until you hit a spot that's covered with ice. On an otherwise clear road, ice patches may appear in shaded areas where the sun can't reach: around clumps of trees, behind buildings or under bridges. Sometimes the surface of a curve or an overpass may remain icy when the surrounding roads are clear. If you see a patch of ice ahead of you, brake before you are on it. Try not to brake while you're actually on the ice, and avoid sudden steering maneuvers.

If You're Caught in a Blizzard

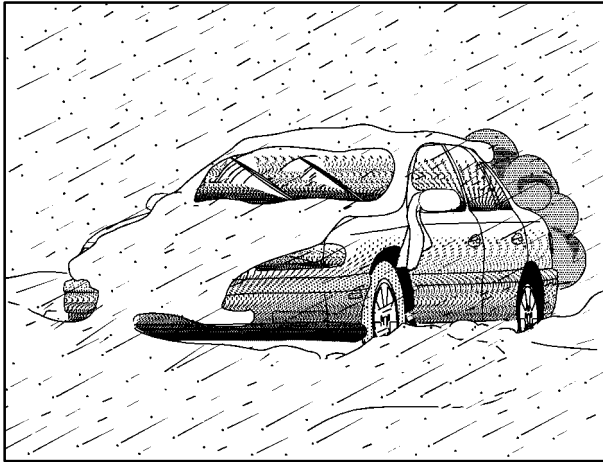

If you are stopped by heavy snow, you could be in a serious situation. You should probably stay with your vehicle unless you know for sure that you are near help and you can hike through the snow. Here are some things to do to summon help and keep yourself and your passengers safe:

- Turn on your hazard flashers.

- Tie a red cloth to your vehicle to alert police that you've been stopped by the snow.
- Put on extra clothing or wrap a blanket around you. If you have no blankets or extra clothing, make body insulators from newspapers, burlap bags, rags, floor mats -- anything you can wrap around yourself or tuck under your clothing to keep warm.

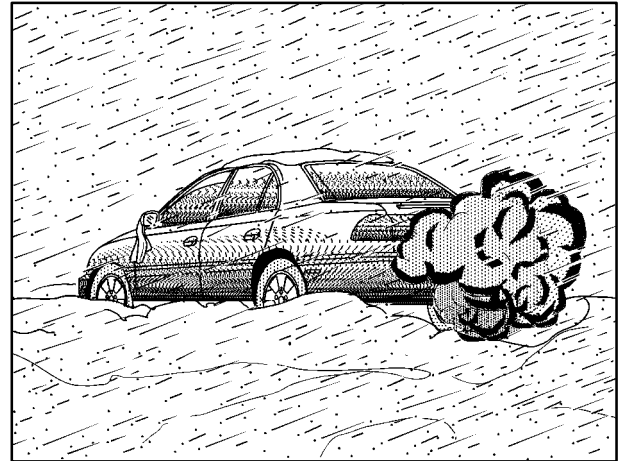

You can run the engine to keep warm, but be careful.

 **CAUTION:**

Snow can trap exhaust gases under your vehicle. This can cause deadly CO (carbon monoxide) gas to get inside. CO could overcome you and kill you. You can't see it or smell it, so you might not know it is in your vehicle. Clear away snow from around the base of your vehicle, especially any that is blocking your exhaust pipe. And check around again from time to time to be sure snow doesn't collect there.

Open a window just a little on the side of the vehicle that's away from the wind. This will help keep CO out.

Run your engine only as long as you must. This saves fuel. When you run the engine, make it go a little faster than just idle. That is, push the accelerator slightly. This uses less fuel for the heat that you get and it keeps the battery charged. You will need a well-charged battery to restart the vehicle, and possibly for signaling later on with your headlamps. Let the heater run for a while.

Then, shut the engine off and close the window almost all the way to preserve the heat. Start the engine again and repeat this only when you feel really uncomfortable from the cold. But do it as little as possible. Preserve the fuel as long as you can. To help keep warm, you can get out of the vehicle and do some fairly vigorous exercises every half hour or so until help comes.

Recreational Vehicle Towing

Your vehicle was not designed to be towed with all four wheels on the ground. If your vehicle must be towed, see "Towing Your Vehicle" in the Index.

NOTICE:

Towing your vehicle with all four wheels on the ground will damage drivetrain components.

⚠ CAUTION:

Do not load your vehicle any heavier than the GVWR, or either the maximum front or rear GAWR. If you do, parts on your vehicle can break, and it can change the way your vehicle handles. These could cause you to lose control and crash. Also, overloading can shorten the life of your vehicle.

NOTICE:

Your warranty does not cover parts or components that fail because of overloading.

If you put things inside your vehicle -- like suitcases, tools, packages or anything else -- they will go as fast as the vehicle goes. If you have to stop or turn quickly, or if there is a crash, they'll keep going.

⚠ CAUTION:

Things you put inside your vehicle can strike and injure people in a sudden stop or turn, or in a crash.

- Put things in the trunk of your vehicle. In a trunk, put them as far forward as you can. Try to spread the weight evenly.
- Never stack heavier things, like suitcases, inside the vehicle so that some of them are above the tops of the seats.
- Don't leave an unsecured child restraint in your vehicle.
- When you carry something inside the vehicle, secure it whenever you can.
- Don't leave a seat folded down unless you need to.

Electronic Level Control

This feature keeps the rear of your vehicle level as the load changes. It's automatic -- you don't need to adjust anything.

Towing a Trailer

CAUTION:

If you don't use the correct equipment and drive properly, you can lose control when you pull a trailer. For example, if the trailer is too heavy, the brakes may not work well -- or even at all. You and your passengers could be seriously injured. You may also damage your vehicle; the resulting repairs would not be covered by your warranty. Pull a trailer only if you have followed all the steps in this section. Ask your dealer for advice and information about towing a trailer with your vehicle.

Your Catera can tow a trailer if it is equipped with the proper trailer towing equipment. To identify what the vehicle trailering capacity is for your vehicle, you should read the information in “Weight of the Trailer” that appears later in this section. But trailering is different than just driving your vehicle by itself. Trailering means changes in handling, durability and fuel economy. Successful, safe trailering takes correct equipment, and it has to be used properly.

That's the reason for this part. In it are many time-tested, important trailering tips and safety rules. Many of these are important for your safety and that of your passengers. So please read this section carefully before you pull a trailer.

Load-pulling components such as the engine, transmission, wheel assemblies and tires are forced to work harder against the drag of the added weight. The engine is required to operate at relatively higher speeds and under greater loads, generating extra heat. What's more, the trailer adds considerably to wind resistance, increasing the pulling requirements.

If You Do Decide To Pull A Trailer

If you do, here are some important points:

- There are many different laws, including speed limit restrictions, having to do with trailering. Make sure your rig will be legal, not only where you live but also where you'll be driving. A good source for this information can be state or provincial police.
- Consider using a sway control. You can ask a hitch dealer about sway controls.
- Don't tow a trailer at all during the first 1,000 miles (1 600 km) your new vehicle is driven. Your engine, axle or other parts could be damaged.

- Then, during the first 500 miles (800 km) that you tow a trailer, don't drive over 50 mph (80 km/h) and don't make starts at full throttle. This helps your engine and other parts of your vehicle wear in at the heavier loads.
- Obey speed limit restrictions when towing a trailer. Don't drive faster than the maximum posted speed for trailers (or no more than 55 mph (90 km/h)) to save wear on your vehicle's parts.

Three important considerations have to do with weight:

- the weight of the trailer,
- the weight of the trailer tongue
- and the total weight on your vehicle's tires.

Weight of the Trailer

How heavy can a trailer safely be?

It should never weigh more than 1,000 lbs. (454 kg). But even that can be too heavy.

It depends on how you plan to use your rig. For example, speed, altitude, road grades, outside temperature and how much your vehicle is used to pull a trailer are all important. And, it can also depend on any special equipment that you have on your vehicle.

You can ask your dealer for our trailering information or advice, or you can write us at:

Cadillac Customer Assistance Center
Cadillac Motor Car Division
P.O. Box 436004
Pontiac, MI 48343-6004

In Canada, write to:

General Motors of Canada Limited
Customer Communication Centre
1908 Colonel Sam Drive
Oshawa, Ontario L1H 8P7

Weight of the Trailer Tongue

The tongue load (A) of any trailer is an important weight to measure because it affects the total or gross weight of your vehicle. The Gross Vehicle Weight (GVW) includes the curb weight of the vehicle, any cargo you may carry in it, and the people who will be riding in the vehicle. And if you tow a trailer, you must add the tongue load to the GVW because your vehicle will be carrying that weight, too. See "Loading Your Vehicle" in the Index for more information about your vehicle's maximum load capacity.

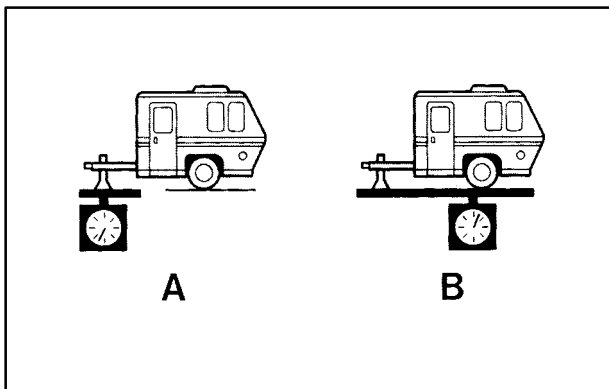

If you're using a weight-carrying hitch, the trailer tongue (A) should weigh 10 percent of the total loaded trailer weight (B). If you have a weight-distributing hitch, the trailer tongue (A) should weigh 12 percent of the total loaded trailer weight (B).

After you've loaded your trailer, weigh the trailer and then the tongue, separately, to see if the weights are proper. If they aren't, you may be able to get them right simply by moving some items around in the trailer.

Total Weight on Your Vehicle's Tires

Be sure your vehicle's tires are inflated to the upper limit for cold tires. You'll find these numbers on the Tire-Loading Information label at the rear edge of the driver's door or see "Loading Your Vehicle" in the Index. Then be sure you don't go over the GVW limit for your vehicle, including the weight of the trailer tongue.

Hitches

It's important to have the correct hitch equipment. Crosswinds, large trucks going by and rough roads are a few reasons why you'll need the right hitch. Here are some rules to follow:

- The rear bumper on your vehicle is not intended for hitches. Do not attach rental hitches or other bumper-type hitches to it. Use only a frame-mounted hitch that does not attach to the bumper.
- Will you have to make any holes in the body of your vehicle when you install a trailer hitch? If you do, then be sure to seal the holes later when you remove the hitch. If you don't seal them, deadly carbon monoxide (CO) from your exhaust can get into your vehicle (see "Carbon Monoxide" in the Index). Dirt and water can, too.

Safety Chains

You should always attach chains between your vehicle and your trailer. Cross the safety chains under the tongue of the trailer so that the tongue will not drop to the road if it becomes separated from the hitch. Instructions about safety chains may be provided by the hitch manufacturer or by the trailer manufacturer. Follow the manufacturer's recommendation for attaching safety chains and do not attach them to the bumper. Always leave just enough slack so you can turn with your rig. And, never allow safety chains to drag on the ground.

Trailer Brakes

Because your vehicle has anti-lock brakes, don't try to tap into the hydraulic brake system. If you do, both brake systems won't work well, or at all.

Be sure to read and follow the instructions for the trailer brakes so you'll be able to install, adjust and maintain them properly.

Driving with a Trailer

Towing a trailer requires a certain amount of experience. Before setting out for the open road, you'll want to get to know your rig. Acquaint yourself with the feel of handling and braking with the added weight of the trailer. And always keep in mind that the vehicle you are driving is now a good deal longer and not nearly as responsive as your vehicle is by itself.

Before you start, check the trailer hitch and platform (and attachments), safety chains, electrical connector, lamps, tires and mirror adjustment. If the trailer has electric brakes, start your vehicle and trailer moving and then apply the trailer brake controller by hand to be sure the brakes are working. This lets you check your electrical connection at the same time.

During your trip, check occasionally to be sure that the load is secure, and that the lamps and any trailer brakes are still working.

Following Distance

Stay at least twice as far behind the vehicle ahead as you would when driving your vehicle without a trailer. This can help you avoid situations that require heavy braking and sudden turns.

Passing

You'll need more passing distance up ahead when you're towing a trailer. And, because you're a good deal longer, you'll need to go much farther beyond the passed vehicle before you can return to your lane.

Backing Up

Hold the bottom of the steering wheel with one hand. Then, to move the trailer to the left, just move that hand to the left. To move the trailer to the right, move your hand to the right. Always back up slowly and, if possible, have someone guide you.

Making Turns

NOTICE:

Making very sharp turns while trailering could cause the trailer to come in contact with the vehicle. Your vehicle could be damaged. Avoid making very sharp turns while trailering.

When you're turning with a trailer, make wider turns than normal. Do this so your trailer won't strike soft shoulders, curbs, road signs, trees or other objects. Avoid jerky or sudden maneuvers. Signal well in advance.

Turn Signals When Towing a Trailer

When you tow a trailer, your vehicle may need a different turn signal flasher and/or extra wiring. Check with your dealer. The arrows on your instrument panel will flash whenever you signal a turn or lane change. Properly hooked up, the trailer lamps will also flash, telling other drivers you're about to turn, change lanes or stop.

When towing a trailer, the arrows on your instrument panel will flash for turns even if the bulbs on the trailer are burned out. Thus, you may think drivers behind you are seeing your signal when they are not. It's important to check occasionally to be sure the trailer bulbs are still working.

Driving On Grades

Reduce speed and shift to a lower gear *before* you start down a long or steep downgrade. If you don't shift down, you might have to use your brakes so much that they would get hot and no longer work well.

On a long uphill grade, shift down and reduce your speed to around 45 mph (70 km/h) or less to reduce the possibility of engine and transmission overheating.

Parking on Hills

CAUTION:

You really should not park your vehicle, with a trailer attached, on a hill. If something goes wrong, your rig could start to move. People can be injured, and both your vehicle and the trailer can be damaged.

But if you ever have to park your rig on a hill, here's how to do it:

1. Apply the regular brakes, but do not shift into PARK (P).
2. Have someone place chocks under the trailer wheels.
3. When the wheel chocks are in place, release the regular brakes until the chocks absorb the load.
4. Reapply the regular brakes. Then shift into PARK (P) firmly and apply the parking brake.
5. Release the regular brakes.

When You Are Ready to Leave After Parking on a Hill

1. Apply your regular brakes and hold the pedal down while you:
 - Start your engine;
 - Shift into a gear; and
 - Be sure the parking brake has released.
2. Let up on the brake pedal.
3. Drive slowly until the trailer is clear of the chocks.
4. Stop and have someone pick up and store the chocks.

Maintenance When Trailer Towing

Your vehicle will need service more often when you're pulling a trailer. See the Maintenance Schedule booklet for more on this. Things that are especially important in trailer operation are automatic transmission fluid (don't overfill), engine oil, axle lubricant, drive belt, cooling system and brake system. If you're trailering, it's a good idea to review this information before you start your trip.

Check periodically to see that all hitch nuts and bolts are tight.

Engine Cooling When Trailer Towing

Your cooling system may temporarily overheat during severe operating conditions. See "Engine Overheating" in the Index.



Section 5 Problems on the Road

Here you'll find what to do about some problems that can occur on the road.

5-2 Hazard Warning Flashers
5-2 Other Warning Devices
5-2 Jump Starting
5-8 Towing Your Vehicle
5-9 Engine Overheating

5-11 Cooling System
5-17 If a Tire Goes Flat
5-18 Changing a Flat Tire
5-28 If You're Stuck: In Sand, Mud, Ice or Snow

Hazard Warning Flashers

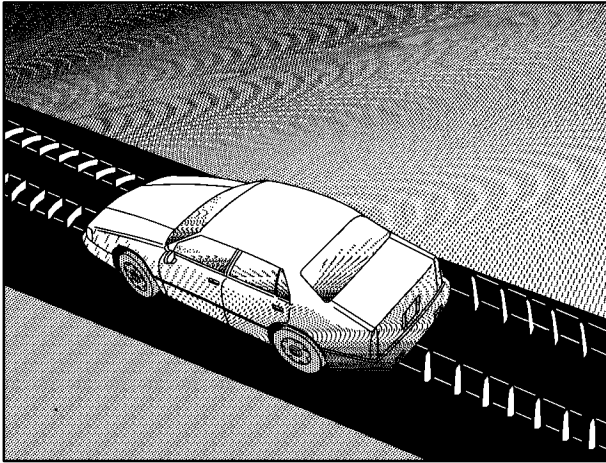

Your hazard warning flashers let you warn others. They also let police know you have a problem. Your front and rear turn signal lamps will flash on and off.



Pressing this button on the center console makes the front and rear turn signal lamps flash on and off. The indicator light on the button also flashes. Pressing the button again turns the flashers off. The flashers work regardless of the key position.

When the hazard warning flashers are on, the turn signals won't work since they are already flashing.

Other Warning Devices

If you carry reflective triangles, you can set one up at the side of the road about 300 feet (100 m) behind your vehicle.

Jump Starting

If the battery has run down, you may want to use another vehicle and some jumper cables to start your vehicle. Please perform the following steps to do it safely.

 **CAUTION:**

Batteries can hurt you. They can be dangerous because:

- They contain acid that can burn you.
- They contain gas that can explode or ignite.
- They contain enough electricity to burn you.

If you don't follow these steps exactly, some or all of these things can hurt you.

NOTICE:

Ignoring these steps could result in costly damage to your vehicle that wouldn't be covered by your warranty.

The ACDelco Freedom[®] battery in your vehicle has a built-in hydrometer. Do not charge, test or jump start the battery if the hydrometer looks

NOTICE: (Continued)

NOTICE: (Continued)

clear or light yellow. Replace the battery when there is a clear or light yellow hydrometer and a cranking complaint.

Trying to start your vehicle by pushing or pulling it won't work, and it could damage your vehicle.

1. Check the other vehicle. It must have a 12-volt battery with a negative ground system.

NOTICE:

If the other system isn't a 12-volt system with a negative ground, both vehicles can be damaged.

2. Get the vehicles close enough so the jumper cables can reach, but be sure the vehicles aren't touching each other. If they are, it could cause a ground connection you don't want. You wouldn't be able to start your vehicle and the bad grounding could damage the electrical systems.

3. Turn off the ignition on both vehicles. Unplug unnecessary accessories plugged into the cigarette lighter. Turn off all lamps that aren't needed as well as the radios. This will avoid sparks and help save both batteries. In addition, it could save the radio!

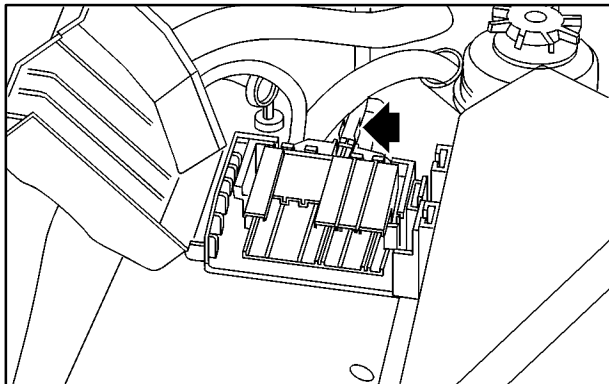

4. Open the hoods and locate the batteries. You'll also need to open the power distribution fuse block cover to access the positive (+) terminal on the battery (see arrow).

⚠ CAUTION:

An electric fan can start up even when the engine is not running and can injure you. Keep hands, clothing and tools away from any underhood electric fan.

⚠ CAUTION:

Using a match near a battery can cause battery gas to explode. People have been hurt doing this, and some have been blinded. Use a flashlight if you need more light.

Be sure the battery has enough water. You don't need to add water to the ACDelco Freedom[®] battery installed in every new GM vehicle. But if a battery has filler caps, be sure the right amount of fluid is there. If it is low, add water to take care of that first. If you don't, explosive gas could be present.

CAUTION: (Continued)

CAUTION: (Continued)

Battery fluid contains acid that can burn you. Don't get it on you. If you accidentally get it in your eyes or on your skin, flush the place with water and get medical help immediately.

5. Check that the jumper cables don't have loose or missing insulation. If they do, you could get a shock. The vehicles could also be damaged.

Before you connect the cables, here are some basic things you should know. Positive (+) will go to positive (+) and negative (-) will go to a heavy, unpainted metal part on the engine of the vehicle with the dead battery. Don't connect positive (+) to negative (-) or you will get a short that would damage the battery and maybe other parts, too. Also, don't connect negative (-) to negative (-).

⚠ CAUTION:

Fans or other moving engine parts can injure you badly. Keep your hands away from moving parts once the engine is running.

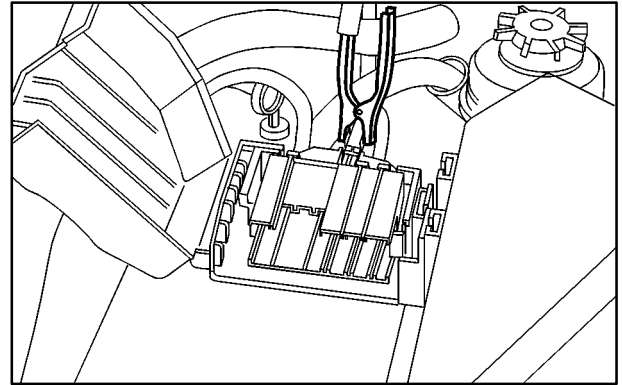

6. Connect the red positive (+) cable to the positive (+) terminal of the vehicle with the dead battery.



7. Don't let the other end of the positive cable touch metal. Connect it to the positive (+) terminal of the good battery.



8. Now connect the negative (-) cable to the good battery's negative (-) terminal.

Don't let the other end of the negative (-) cable touch anything until the next step. The other end of the negative (-) cable *doesn't* go to the dead battery. It goes to a heavy unpainted metal part on the engine of the vehicle with the dead battery.

9. Attach the cable at least 18 inches (45 cm) away from the dead battery, but not near engine parts that move.



A good spot to attach the negative (-) cable is on the bracket between the engine coolant surge tank and the engine block.

10. Now start the vehicle with the good battery and run the engine for a while.
11. Try to start the vehicle with the dead battery. If it won't start after a few tries, it probably needs service.
12. Remove the cables in reverse order to prevent electrical shorting. Take care that they don't touch each other or any other metal.

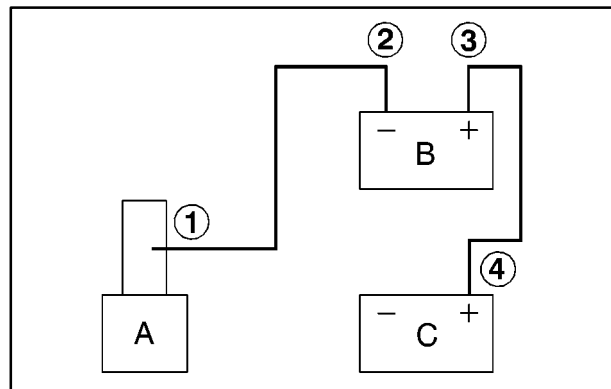

- A. Heavy Metal Engine Part
(Vehicle with Dead Battery)
- B. Good Battery
- C. Dead Battery

Note: When a power loss occurs, there are steps that must be followed to calibrate the Electronic Throttle Control (ETC). If these steps are not done, the engine will not run properly. For information regarding these steps, see “Battery” in the Index.

Towing Your Vehicle

CAUTION:

To help avoid serious personal injury to you or others:

- Never let passengers ride in a vehicle that is being towed.
- Never tow faster than safe or posted speeds.
- Never tow with damaged parts not fully secured.
- Never get under your vehicle after it has been lifted by the tow truck.
- Always secure the vehicle on each side with separate safety chains when towing it.
- Use only the correct hooks.

NOTICE:

Use the proper towing equipment to avoid damage to the bumper, fascia or fog lamp areas of the vehicle.

With current trends in automotive styles and design, it is essential that the correct towing equipment is used to tow a vehicle. Your vehicle can be towed with car-carrier equipment only. Vehicle speed during towing should not exceed 50 mph (80 kph) with a maximum towing distance of 60 miles (100 km).

Consult your dealer or a professional towing service if you need to have your vehicle towed. See “Roadside Assistance” in the Index.

Engine Overheating

You will find the warning light about a hot engine on the instrument panel.

If Steam Is Coming From Your Engine



CAUTION:

Steam from an overheated engine can burn you badly, even if you just open the hood. Stay away from the engine if you see or hear steam coming from it. Just turn it off and get everyone away from the vehicle until it cools down. Wait until there is no sign of steam or coolant before you open the hood.

If you keep driving when your engine is overheated, the liquids in it can catch fire. You or others could be badly burned. Stop your engine if it overheats, and get out of the vehicle until the engine is cool.

NOTICE:

If your engine catches fire because you keep driving with no coolant, your vehicle can be badly damaged. The costly repairs would not be covered by your warranty.

If No Steam Is Coming From Your Engine

If you get an engine overheat warning but see or hear no steam, the problem may not be too serious. Sometimes the engine can get a little too hot when you:

- Climb a long hill on a hot day.
- Stop after high-speed driving.
- Idle for long periods in traffic.
- Tow a trailer.

If you get the overheat warning with no sign of steam, try this for a minute or so:

1. If your air conditioner is on, turn it off.
2. Dial temperature control to the highest heat setting and open the windows, as necessary.
3. If you're in a traffic jam, shift to NEUTRAL (N); otherwise, shift to the highest gear while driving -- DRIVE (D) or THIRD (3).

If you no longer have the overheat warning, you can drive. Just to be safe, drive slower for about 10 minutes. If the warning doesn't come back on, you can drive normally.

If the warning continues, pull over, stop, and park your vehicle right away.

If there's still no sign of steam, idle the engine for three minutes while you're parked. If you still have the warning, *turn off the engine and get everyone out of the vehicle* until it cools down.

You may decide not to lift the hood but to get service help right away.

Cooling System

When you decide it's safe to lift the hood, here's what you'll see:



- A. Coolant Surge Tank with Pressure Cap
- B. Electric Engine Cooling Fans

CAUTION:

An electric engine cooling fan under the hood can start up even when the engine is not running and can injure you. Keep hands, clothing and tools away from any underhood electric fan.

If the coolant inside the coolant surge tank is boiling, don't do anything else until it cools down.



The coolant level should be at or slightly above the KALT/COLD line (seam).

If it isn't, you may have a leak in the radiator hoses, heater hoses, radiator, water pump or somewhere else in the cooling system.

 **CAUTION:**

Heater and radiator hoses, and other engine parts, can be very hot. Don't touch them. If you do, you can be burned.

Don't run the engine if there is a leak. If you run the engine, it could lose all coolant. That could cause an engine fire, and you could be burned. Get any leak fixed before you drive the vehicle.

NOTICE:

Engine damage from running your engine without coolant isn't covered by your warranty.

NOTICE:

When adding coolant, it is important that you use only DEX-COOL[®] (silicate-free) coolant.

If coolant other than DEX-COOL is added to the system, premature engine, heater core or radiator corrosion may result. In addition, the engine coolant will require change sooner -- at 30,000 miles (50 000 km) or 24 months, whichever occurs first. Damage caused by the use of coolant other than DEX-COOL[®] is not covered by your new vehicle warranty.

If there seems to be no leak, with the engine on, check to see if the electric engine cooling fans are running. If the engine is overheating, both fans should be running. If they aren't, your vehicle needs service.

How to Add Coolant to the Coolant Surge Tank

If you haven't found a problem yet, but the coolant level isn't at the KALT/COLD line (seam), add a 50/50 mixture of *clean, drinkable water* and DEX-COOL[®] coolant at the coolant surge tank, but be sure the cooling system, including the coolant surge tank pressure cap, is cool before you do it. (See "Engine Coolant" in the Index for more information.)

CAUTION:

Steam and scalding liquids from a hot cooling system can blow out and burn you badly. They are under pressure, and if you turn the coolant surge tank pressure cap -- even a little -- they can come out at high speed. Never turn the cap when the cooling system, including the coolant surge tank pressure cap, is hot. Wait for the cooling system and coolant surge tank pressure cap to cool if you ever have to turn the pressure cap.



 **CAUTION:**

Adding only plain water to your cooling system can be dangerous. Plain water, or some other liquid like alcohol, can boil before the proper coolant mixture will. Your vehicle's coolant warning system is set for the proper coolant mixture. With plain water or the wrong mixture, your engine could get too hot but you wouldn't get the overheat warning. Your engine could catch fire and you or others could be burned. Use a 50/50 mixture of clean, drinkable water and DEX-COOL[®] coolant.

NOTICE:

In cold weather, water can freeze and crack the engine, radiator, heater core and other parts. So use the recommended coolant.

 **CAUTION:**

You can be burned if you spill coolant on hot engine parts. Coolant contains ethylene glycol and it will burn if the engine parts are hot enough. Don't spill coolant on a hot engine.



1. You can remove the coolant surge tank pressure cap when the cooling system, including the coolant surge tank pressure cap and upper radiator hose, is no longer hot. Turn the pressure cap slowly counterclockwise (left) until it first stops. (Don't press down while turning the pressure cap.)

If you hear a hiss, wait for that to stop. A hiss means there is still some pressure left.

2. Then keep turning the pressure cap slowly, and remove it.



3. Then fill the coolant surge tank with the proper mixture, to the KALT/COLD line (seam).



4. With the coolant surge tank pressure cap off, start the engine and let it run until you can feel the upper radiator hose getting hot. Watch out for the engine cooling fans.

By this time, the coolant level inside the coolant surge tank may be lower. If the level is lower, add more of the proper mixture to the coolant surge tank until the level reaches the KALT/COLD line (seam).



5. Then replace the pressure cap. Be sure the pressure cap is hand-tight.

If a Tire Goes Flat

It's unusual for a tire to “blow out” while you're driving, especially if you maintain your tires properly. If air goes out of a tire, it's much more likely to leak out slowly. But if you should ever have a “blowout,” here are a few tips about what to expect and what to do:

If a front tire fails, the flat tire will create a drag that pulls the vehicle toward that side. Take your foot off the accelerator pedal and grip the steering wheel firmly. Steer to maintain lane position, and then gently brake to a stop well out of the traffic lane.

A rear blowout, particularly on a curve, acts much like a skid and may require the same correction you'd use in a skid. In any rear blowout, remove your foot from the accelerator pedal. Get the vehicle under control by steering the way you want the vehicle to go. It may be very bumpy and noisy, but you can still steer. Gently brake to a stop -- well off the road if possible.

If a tire goes flat, the next part shows how to use your jacking equipment to change a flat tire safely.

Changing a Flat Tire

If a tire goes flat, avoid further tire and wheel damage by driving slowly to a level place. Turn on your hazard warning flashers.

CAUTION:

Changing a tire can cause an injury. The vehicle can slip off the jack and roll over you or other people. You and they could be badly injured. Find a level place to change your tire. To help prevent the vehicle from moving:

1. Put the shift lever in PARK (P).
2. Set the parking brake firmly.
3. Turn off the engine.

To be even more certain the vehicle won't move, you can put blocks at the front and rear of the tire farthest away from the one being changed. That would be the tire on the other side of the vehicle, at the opposite end.

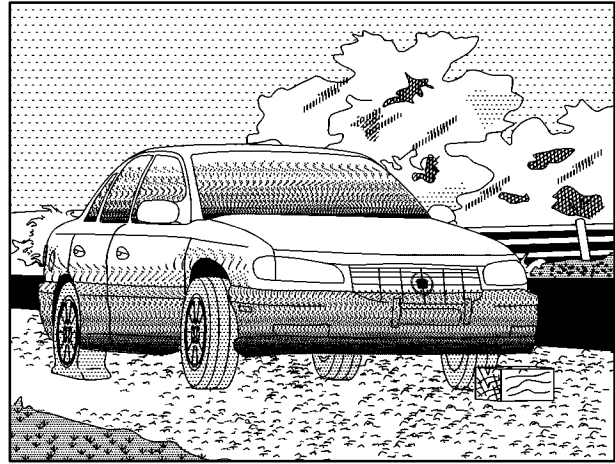

The following steps will tell you how to use the jack and change a tire.

Removing the Spare Tire and Tools

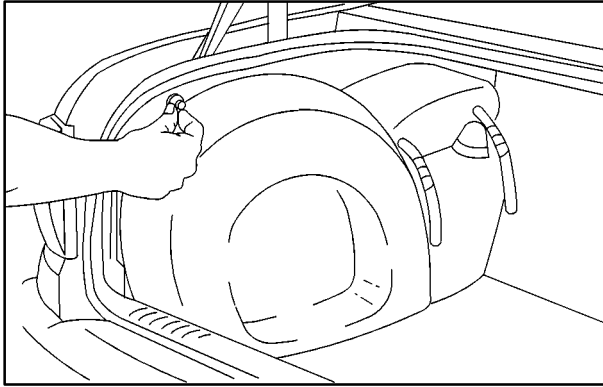

The equipment you'll need is in the trunk. On the driver's side of the trunk is the spare tire. Pull the fasteners on the spare tire cover to access the tire.

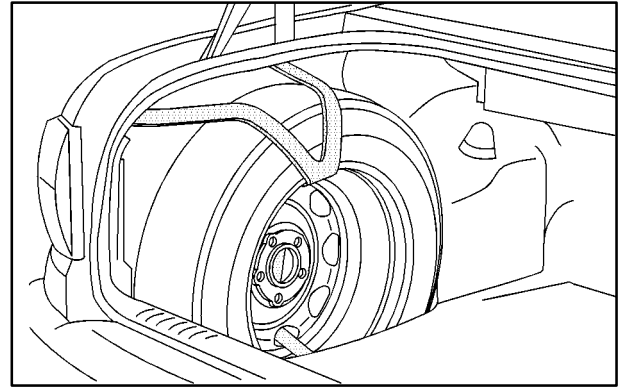

Unbuckle the tire and lift it up to remove it from the trunk.



The jack and tool kit are located on the passenger's side of the trunk. Pull the red handle to remove the cover and access the equipment.



Turn the nut holding the jack counterclockwise and remove it.

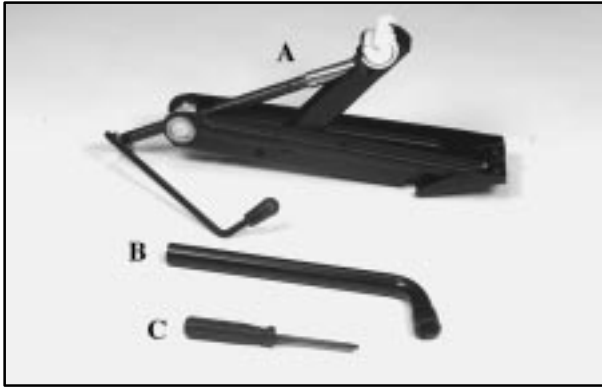

The tools you'll be using include the jack (A), the wheel wrench (B) and the screwdriver (C).

Removing the Flat Tire and Installing the Spare Tire

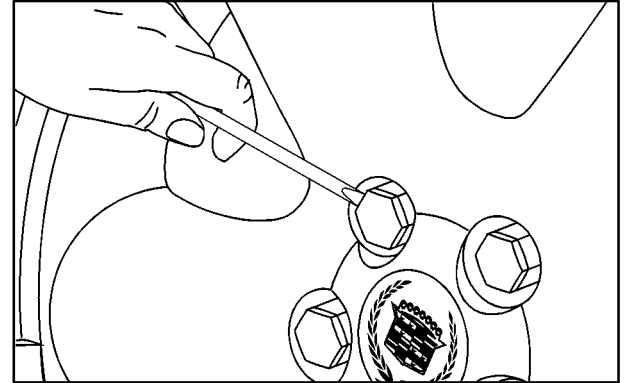

1. Use the flat end of the screwdriver to pry off the five black plastic wheel bolt caps. Be careful not to scratch the wheel edge.

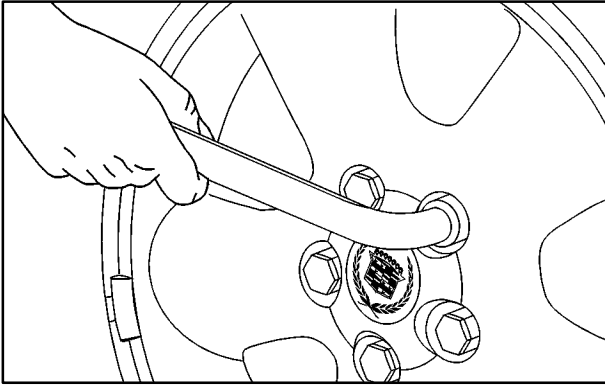

2. Using the wheel wrench, loosen all of the wheel bolts. Don't remove them yet.
3. Turn the jack handle clockwise to raise the jack lift head 2 to 3 inches (5 to 7.6 cm).



4. To access the jack hoisting notches, pull hard from the back of the hoisting notch cover (located either in front of or behind the tire you are changing).

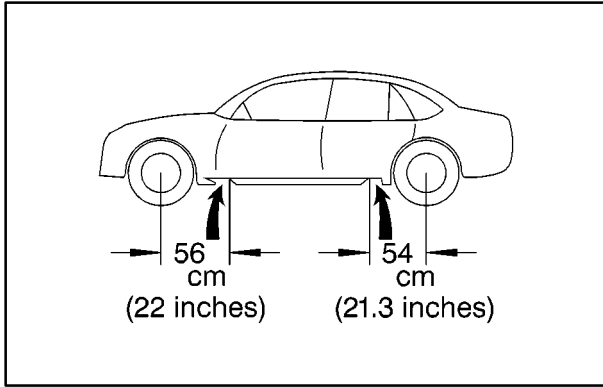

5. Position the jack under the vehicle.

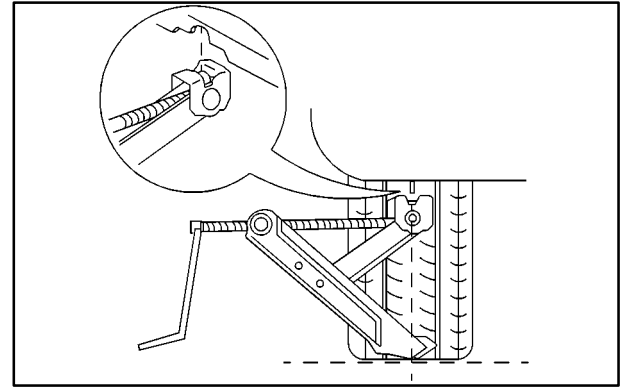

The base of the jack must line up vertically with the hoisting notch (jack contact point) on the vehicle's frame, nearest the flat tire. Make sure that the base is flat against the ground in order to have enough clearance to turn the jack handle. Then, raise the jack lift head until it is firmly set into the hoisting notch.

⚠ CAUTION:

Getting under a vehicle when it is jacked up is dangerous. If the vehicle slips off the jack, you could be badly injured or killed. Never get under a vehicle when it is supported only by a jack.

⚠ CAUTION:

Raising your vehicle with the jack improperly positioned can damage the vehicle and even make the vehicle fall. To help avoid personal injury and vehicle damage, be sure to fit the jack lift head into the proper location before raising the vehicle.



6. Raise the vehicle by turning the jack handle clockwise. Raise the vehicle far enough off the ground for the spare tire to fit under the vehicle.
7. Remove all wheel bolts and take off the flat tire.

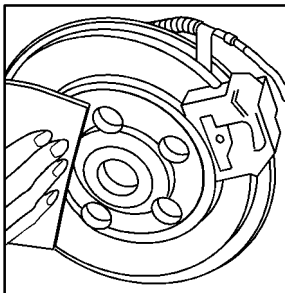

8. Remove any rust or dirt from the wheel bolts, mounting surfaces and spare wheel.

⚠ CAUTION:

Rust or dirt on the wheel, or on the parts to which it is fastened, can make the wheel bolts become loose after a time. The wheel could come off and cause an accident. When you change a wheel, remove any rust or dirt from the places where the wheel attaches to the vehicle. In an emergency, you can use a cloth or a paper towel to do this; but be sure to use a scraper or wire brush later, if you need to, to get all the rust or dirt off.

⚠ CAUTION:

Never use oil or grease on wheel bolts. If you do, the bolts might come loose. Your wheel could fall off, causing a serious accident.

9. Place the wheel on the wheel-mounting surface.



10. Replace the wheel bolts. Tighten each bolt by hand until the wheel is held against the hub.



11. Lower the vehicle by turning the jack handle counterclockwise. Lower the jack completely. After removing the jack, slide the jack hoisting notch cover back in.

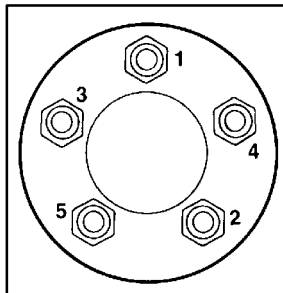

12. Tighten the wheel bolts firmly in a crisscross sequence as shown.

⚠ CAUTION:

Incorrect wheel bolts or improperly tightened wheel bolts can cause the wheel to become loose and even come off. This could lead to an accident. Be sure to use the correct wheel bolts. If you have to replace them, be sure to get new GM original equipment wheel bolts.

Stop somewhere as soon as you can and have the bolts tightened with a torque wrench to 80 lb-ft (110 N·m).

NOTICE:

Improperly tightened wheel bolts can lead to brake pulsation and rotor damage. To avoid expensive brake repairs, evenly tighten the wheel bolts in the proper sequence and to the proper torque specification.

Storing a Flat or Spare Tire and Tools**⚠ CAUTION:**

Storing a jack, a tire or other equipment in the passenger compartment of the vehicle could cause injury. In a sudden stop or collision, loose equipment could strike someone. Store all these in the proper place.

After you've put the spare tire on your vehicle, you'll need to store the flat tire in the trunk. Use the following procedure to secure the flat tire in the trunk.

LEFT SIDE OF TRUNK:

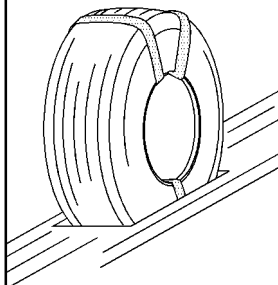

Put the flat tire in the trunk where the spare is stored (driver's side wheel well). Secure the flat tire with the straps that are used to hold the spare in place.

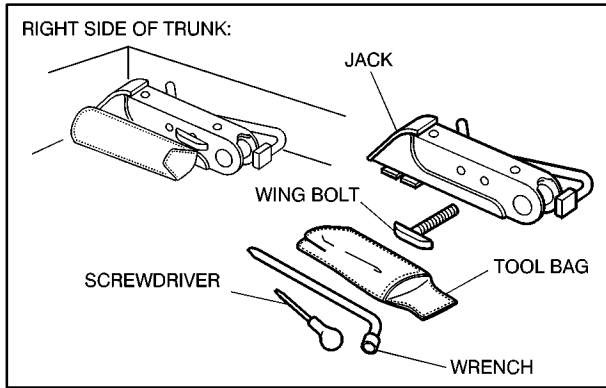

The jacking tools are stored on the passenger's side of the trunk behind the panel with the red pull handle. Make sure these tools are properly secured when not in use.

If You're Stuck: In Sand, Mud, Ice or Snow

In order to free your vehicle when it is stuck, you will need to spin the wheels, but you don't want to spin your wheels too fast. The method known as "rocking" can help you get out when you're stuck, but you must use caution.

⚠ CAUTION:

If you let your tires spin at high speed, they can explode, and you or others could be injured. And, the transmission or other parts of the vehicle can overheat. That could cause an engine compartment fire or other damage. When you're stuck, spin the wheels as little as possible. Don't spin the wheels above 35 mph (55 km/h) as shown on the speedometer.

NOTICE:

Spinning your wheels can destroy parts of your vehicle as well as the tires. If you spin the wheels too fast while shifting your transmission back and forth, you can destroy your transmission.

For information about using tire chains on your vehicle, see “Tire Chains” in the Index.

Rocking Your Vehicle To Get It Out

First, turn your steering wheel left and right. That will clear the area around your front wheels. You should turn your traction control system off. (See “Traction Control System” in the Index.) Then shift back and forth between REVERSE (R) and a forward gear, spinning the wheels as little as possible. Release the accelerator pedal while you shift, and press lightly on the accelerator pedal when the transmission is in gear. By slowly spinning your wheels in the forward and reverse directions, you will cause a rocking motion that may free your vehicle. If that doesn’t get you out after a few tries, you may need to be towed out. If you do need to be towed out, see “Towing Your Vehicle” in the Index.



Section 6 Service and Appearance Care

Here you will find information about the care of your vehicle. This section begins with service and fuel information, and then it shows how to check important fluid and lubricant levels. There is also technical information about your vehicle, and a part devoted to its appearance care.

6-2	Service	6-37	Tires
6-3	Fuel	6-46	Appearance Care
6-5	Fuels in Foreign Countries	6-46	Cleaning the Inside of Your Vehicle
6-5	Filling Your Tank	6-48	Care of Safety Belts
6-8	Checking Things Under the Hood	6-49	Cleaning the Outside of Your Vehicle
6-11	Engine Oil	6-51	Cleaning Aluminum or Chrome-Plated Wheels (If Equipped)
6-15	Engine Air Cleaner/Filter	6-52	Underbody Maintenance
6-18	Automatic Transmission Fluid	6-53	GM Vehicle Care/Appearance Materials
6-19	Rear Axle	6-54	Vehicle Identification Number (VIN)
6-20	Surge Tank Pressure Cap	6-54	Service Parts Identification Label
6-20	Engine Coolant	6-55	Electrical System
6-24	Power Steering Fluid	6-62	Replacement Bulbs
6-25	Windshield Washer Fluid	6-62	Capacities and Specifications
6-26	Brakes	6-63	Air Conditioning Refrigerants
6-29	Battery	6-63	Normal Maintenance Replacement Parts
6-30	Bulb Replacement		
6-36	Wiper Blade Replacement		

Service

Your dealer knows your vehicle best and wants you to be happy with it. We hope you'll go to your dealer for all your service needs. You'll get genuine GM parts and GM-trained and supported service people.

We hope you'll want to keep your GM vehicle all GM. Genuine GM parts have one of these marks:

ACDelco[®]

Genuine



Parts



Goodwrench

Doing Your Own Service Work

If you want to do some of your own service work, you'll want to use the proper service manual. It tells you much more about how to service your vehicle than this manual can. To order the proper service manual, see "Service and Owner Publications" in the Index.

Your vehicle has an air bag system. Before attempting to do your own service work, see "Servicing Your Air Bag-Equipped Vehicle" in the Index.

You should keep a record with all parts receipts and list the mileage and the date of any service work you perform. See "Maintenance Record" in the Maintenance Schedule booklet.



CAUTION:

You can be injured and your vehicle could be damaged if you try to do service work on a vehicle without knowing enough about it.

- **Be sure you have sufficient knowledge, experience, the proper replacement parts and tools before you attempt any vehicle maintenance task.**
- **Be sure to use the proper nuts, bolts and other fasteners. “English” and “metric” fasteners can be easily confused. If you use the wrong fasteners, parts can later break or fall off. You could be hurt.**

Adding Equipment to the Outside of Your Vehicle

Things you might add to the outside of your vehicle can affect the airflow around it. This may cause wind noise and affect windshield washer performance. Check with your dealer before adding equipment to the outside of your vehicle.

Fuel

Use premium unleaded gasoline rated at 91 octane or higher for best performance. You may use middle grade or regular unleaded gasolines, but your vehicle may not accelerate as well.

It is recommended that the gasoline meet specifications which have been developed by the American Automobile Manufacturers Association (AAMA) and endorsed by the Canadian Motor Vehicle Manufacturers Association for better vehicle performance and engine protection. Gasolines meeting the AAMA specification could provide improved driveability and emission control system performance compared to other gasolines. For more information, write to: American Automobile Manufacturer’s Association, 7430 Second Ave, Suite 300, Detroit MI 48202.

Be sure the posted octane for premium is at least 91 (at least 89 for middle grade and 87 for regular). If the octane is less than 87, you may get a heavy knocking noise when you drive. If it’s bad enough, it can damage your engine.

If you’re using fuel rated at the recommended octane or higher and you hear heavy knocking, your engine needs service. But don’t worry if you hear a little pinging noise when you’re accelerating or driving up a hill.

That's normal, and you don't have to buy a higher octane fuel to get rid of pinging. It's the heavy, constant knock that means you have a problem.

If your vehicle is certified to meet California Emission Standards (indicated on the underhood emission control label), it is designed to operate on fuels that meet California specifications. If such fuels are not available in states adopting California emissions standards, your vehicle will operate satisfactorily on fuels meeting federal specifications, but emission control system performance may be affected. The malfunction indicator lamp on your instrument panel may turn on and/or your vehicle may fail a smog-check test. (See "Malfunction Indicator Lamp" in the Index.) If this occurs, return to your authorized Catera dealer for diagnosis to determine the cause of failure. In the event it is determined that the cause of the condition is the type of fuels used, repairs may not be covered by your warranty.

Some gasolines that are not reformulated for low emissions may contain an octane-enhancing additive called methylcyclopentadienyl manganese tricarbonyl (MMT); ask your service station operator whether or not the fuel contains MMT. General Motors does not recommend the use of such gasolines. If fuels containing MMT are used, spark plug life may be reduced and your

emission control system performance may be affected. The malfunction indicator lamp on your instrument panel may turn on. If this occurs, return to your authorized Catera dealer for service.

To provide cleaner air, all gasolines in the United States are now required to contain additives that will help prevent deposits from forming in your engine and fuel system, allowing your emission control system to function properly. Therefore, you should not have to add anything to the fuel. In addition, gasolines containing oxygenates, such as ethers and ethanol, and reformulated gasolines may be available in your area to contribute to clean air. General Motors recommends that you use these gasolines, particularly if they comply with the specifications described earlier.

NOTICE:

Your vehicle was not designed for fuel that contains methanol. Don't use it. It can corrode metal parts in your fuel system and also damage plastic and rubber parts. That damage wouldn't be covered under your warranty.

Fuels in Foreign Countries

If you plan on driving in another country outside the United States or Canada, the proper fuel may be hard to find. Never use leaded gasoline or any other fuel not recommended in the previous text on fuel. Costly repairs caused by use of improper fuel wouldn't be covered by your warranty.

To check on fuel availability, ask an auto club, or contact a major oil company that does business in the country where you'll be driving.

You can also write us at the following address for advice. Just tell us where you're going and give your Vehicle Identification Number (VIN).

General Motors Overseas Distribution Corporation
1908 Colonel Sam Drive
Oshawa, Ontario L1H 8P7

Filling Your Tank



The cap is behind a hinged door on the passenger's side of your vehicle.

⚠ CAUTION:

Gasoline vapor is highly flammable. It burns violently, and that can cause very bad injuries. Don't smoke if you're near gasoline or refueling your vehicle. Keep sparks, flames and smoking materials away from gasoline.



To open your fuel door, your vehicle must be in PARK (P). Press the FUEL DOOR unlock button located on the instrument panel center console to unlock and open the fuel door.

You can also press the fuel button on the remote keyless entry transmitter to access the fuel cap.



Your vehicle has a tethered fuel cap.

To remove the cap, turn it slowly to the left (counterclockwise). The cap has a spring in it; if you let go of the cap too soon, it will spring back to the right.

 **CAUTION:**

If you get gasoline on yourself and then something ignites it, you could be badly burned. Gasoline can spray out on you if you open the fuel filler cap too quickly. This spray can happen if your tank is nearly full, and is more likely in hot weather. Open the fuel filler cap slowly and wait for any “hiss” noise to stop. Then unscrew the cap all the way.

Be careful not to spill gasoline. Clean gasoline from painted surfaces as soon as possible. See “Cleaning the Outside of Your Vehicle” in the Index.

When you put the cap back on, turn it to the right (clockwise) until you hear a clicking sound. Make sure you fully install the cap. The diagnostic system can determine if the fuel cap has been left off or improperly installed. This would allow fuel to evaporate into the atmosphere. See “Malfunction Indicator Lamp” in the Index.

The FUEL CAP light will come on if the fuel cap is not properly reinstalled.

NOTICE:

If you need a new cap, be sure to get the right type. Your dealer can get one for you. If you get the wrong type, it may not fit properly. This may cause your malfunction indicator lamp to light and your fuel tank and emissions system may be damaged. See “Malfunction Indicator Lamp” in the Index.

Filling a Portable Fuel Container

CAUTION:

Never fill a portable fuel container while it is in your vehicle. Static electricity discharge from the container can ignite the gasoline vapor. You can be badly burned and your vehicle damaged if this occurs. To help avoid injury to you and others:

- Dispense gasoline only into approved containers.
- Do not fill a container while it is inside a vehicle, in a vehicle's trunk, pickup bed or on any surface other than the ground.
- Bring the fill nozzle in contact with the inside of the fill opening before operating the nozzle. Contact should be maintained until the filling is complete.
- Don't smoke while pumping gasoline.

Checking Things Under the Hood

CAUTION:

An electric fan under the hood can start up and injure you even when the engine is not running. Keep hands, clothing and tools away from any underhood electric fan.

CAUTION:

Things that burn can get on hot engine parts and start a fire. These include liquids like gasoline, oil, coolant, brake fluid, windshield washer and other fluids, and plastic or rubber. You or others could be burned. Be careful not to drop or spill things that will burn onto a hot engine.

Hood Release

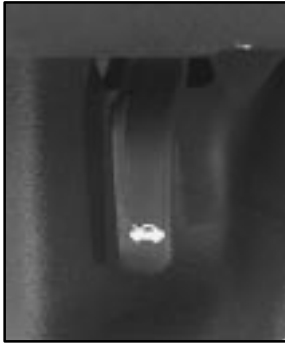

Pull the lever inside the vehicle to open the hood. It is located on the lower left side of the instrument panel.



Then go to the front of the vehicle and find the secondary hood release which is located above the front grille. Lift up on the release lever as you raise the hood.

When you open the hood, you'll see:

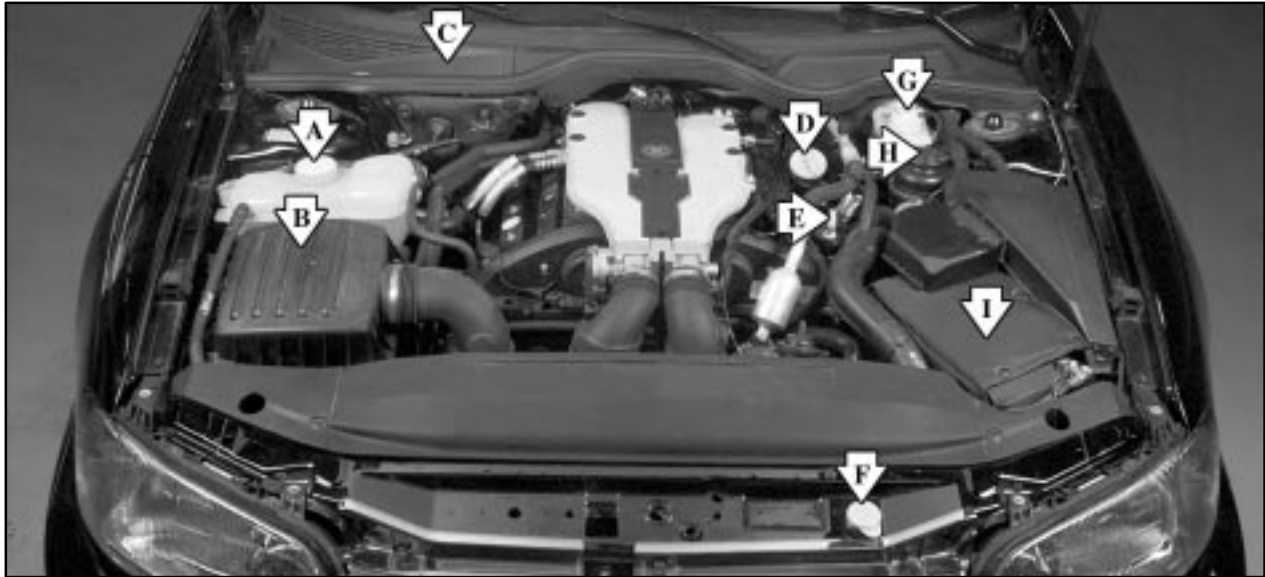

A. Coolant Fill Location
B. Engine Air Cleaner/Filter
C. Passenger Compartment
Air Filter

D. Engine Oil Fill Location
E. Engine Oil Dipstick Location
F. Windshield Washer Fluid

G. Brake Master Cylinder
H. Power Steering Fluid
I. Battery

Before closing the hood, be sure all filler caps are on properly. Then pull the hood down and close it firmly.

Engine Oil

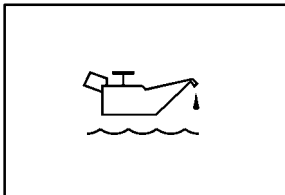

If the low oil level light on the instrument panel comes on, it means you need to check your engine oil level right away.

For more information, see “CHECK OIL light” in the Index. You should check your engine oil level regularly; this is an added reminder.

It’s a good idea to check your engine oil every time you get fuel. In order to get an accurate reading, the oil must be warm and the vehicle must be on level ground.



The engine oil dipstick is located behind the radiator hose on the driver’s side of the engine. The yellow looped handle helps to identify it.

Turn off the engine and give the oil several minutes to drain back into the oil pan. If you don’t, the oil dipstick might not show the actual level.

Checking Engine Oil

Pull out the dipstick and clean it with a paper towel or cloth, then push it back in all the way. Remove it again, keeping the tip down, and check the level.

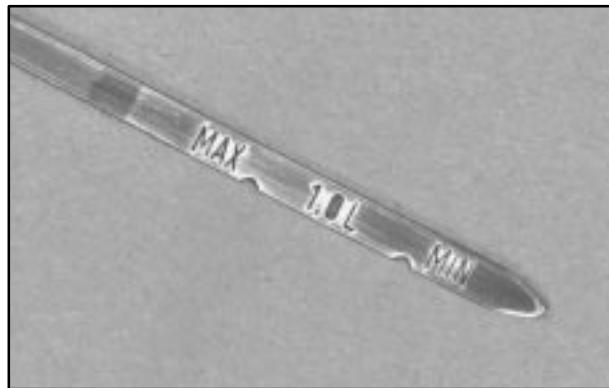

When to Add Engine Oil

If the oil is at or below the MIN mark, then you'll need to add at least one quart of oil. But you must use the right kind. This part explains what kind of oil to use. For crankcase capacity, see "Capacities and Specifications" in the Index.

NOTICE:

Don't add too much oil. If your engine has so much oil that the oil level gets above the upper mark that shows the proper operating range, your engine could be damaged.



The oil fill cap is located behind the engine oil dipstick and next to the engine block on the driver's side of the engine. Turn the yellow cap counterclockwise to remove it.

Be sure to fill it enough to put the level somewhere in the proper operating range. Push the dipstick all the way back in when you're through.

What Kind of Engine Oil to Use

Oils recommended for your vehicle can be identified by looking for the "Starburst" symbol. This symbol indicates that the oil has been certified by the American Petroleum Institute (API). Do not use any oil which does not carry this Starburst symbol.



If you change your own oil, be sure you use oil that has the Starburst symbol on the front of the oil container. If you have your oil changed for you, be sure the oil put into your engine is American Petroleum Institute certified for gasoline engines.

You should also use the proper viscosity oil for your vehicle, as shown in the following chart:

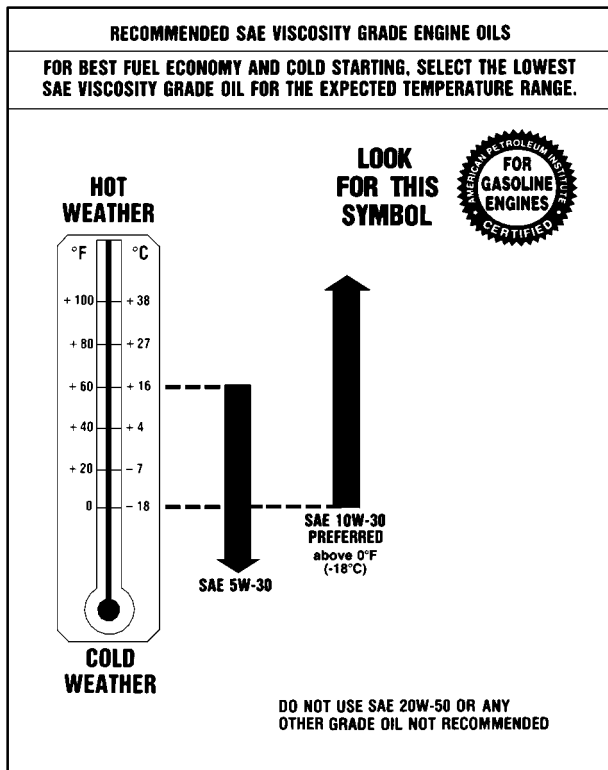

As shown in the chart, SAE 10W-30 is best for your vehicle. However, you can use SAE 5W-30 if it's going to be colder than 60°F (16°C) before your next oil change. When it's very cold, you should use SAE 5W-30. These numbers on an oil container show its viscosity, or thickness. Do not use other viscosity oils, such as SAE 20W-50.

NOTICE:

Use only engine oil with the American Petroleum Institute Certified For Gasoline Engines “Starburst” symbol. Failure to use the recommended oil can result in engine damage not covered by your warranty.

GM Goodwrench[®] oil meets all the requirements for your vehicle.

If you are in an area where the temperature falls below -20°F (-29°C), consider using either an SAE 5W-30 synthetic oil or an SAE 0W-30 oil. Both will provide easier cold starting and better protection for your engine at extremely low temperatures.

Engine Oil Additives

Don't add anything to your oil. Your dealer is ready to advise if you think something should be added.

When to Change Engine Oil

If any one of these is true for you, use the short trip/city maintenance schedule:

- Most trips are less than 5 to 10 miles (8 to 16 km). This is particularly important when outside temperatures are below freezing.
- Most trips include extensive idling (such as frequent driving in stop-and-go traffic).
- Most trips are through dusty areas.
- You frequently tow a trailer or use a carrier on top of your Catera.
- The vehicle is used for delivery service, police, taxi or other commercial application.

Driving under these conditions causes engine oil to break down sooner. If any one of these is true for your vehicle, then you need to change your oil and filter every 5,000 miles (8 000 km) or 3 months -- whichever occurs first.

If none of them is true, use the long trip/highway maintenance schedule. Change the oil and filter at the first 5,000 miles (8 000 km) or 3 months -- whichever occurs first. Then, change the oil and filter every 10,000 miles (16 000 km) or 12 months -- whichever occurs first. Driving a vehicle with a fully warmed engine under highway conditions causes engine oil to break down slower.

What to Do with Used Oil

Did you know that used engine oil contains certain elements that may be unhealthy for your skin and could even cause cancer? Don't let used oil stay on your skin for very long. Clean your skin and nails with soap and water, or a good hand cleaner. Wash or properly throw away clothing or rags containing used engine oil. (See the manufacturer's warnings about the use and disposal of oil products.)

Used oil can be a real threat to the environment. If you change your own oil, be sure to drain all free-flowing oil from the filter before disposal. Don't ever dispose of oil by putting it in the trash, pouring it on the ground, into sewers, or into streams or bodies of water. Instead, recycle it by taking it to a place that collects used oil. If you have a problem properly disposing of your used oil, ask your dealer, a service station or a local recycling center for help.

Engine Air Cleaner/Filter



The air cleaner is located behind the headlamps on the passenger's side of the engine. Be sure the engine has cooled before following these steps to replace the air filter.



1. Unhook the five clips that attach the air cleaner lid to the housing. You may need to use a screwdriver to help you unhook the clips.
2. With a screwdriver, loosen the retaining clamp on the air intake tube and then disconnect the tube as shown by the arrow above.
3. Move the hose going to the coolant surge tank out of the way so the air cleaner lid can be lifted.



4. Lift the lid, take out the air filter and remove any loose debris that may be found lying in the air cleaner base.
5. Install a new air filter element. See “Normal Maintenance Replacement Parts” in the Index.

To reinstall the air cleaner assembly, place the air filter in the air cleaner lid, then insert the lid and filter together into the housing. Reattach the five clips, replace the air intake tube and tighten the clamp. Return the coolant surge tank hose to its proper position.

Refer to the Maintenance Schedule to determine when to replace the air filter.

See “Scheduled Maintenance Services” in the Maintenance Schedule booklet.

CAUTION:

Operating the engine with the air cleaner/filter off can cause you or others to be burned. The air cleaner not only cleans the air, it stops flame if the engine backfires. If it isn't there, and the engine backfires, you could be burned. Don't drive with it off, and be careful working on the engine with the air cleaner/filter off.

NOTICE:

If the air cleaner/filter is off, a backfire can cause a damaging engine fire. And, dirt can easily get into your engine, which will damage it. Always have the air cleaner/filter in place when you're driving.

Passenger Compartment Air Filter Replacement

The passenger compartment air filter traps most of the pollen from the air entering your vehicle. Like your vehicle's air cleaner filter, it may need to be changed periodically. For how often to change the passenger compartment air filter, see your Maintenance Schedule booklet.



The access panel for the passenger compartment air filter is below the grille, at the base of the windshield on the passenger's side of the engine compartment.

1. Open the hood of your vehicle.
2. Lift the engine compartment rear seal (see the arrow in the illustration) and pull it back far enough to be able to lift open the grille flap.
3. Unhook both retaining clips that secure the filter in place.
4. Slide the filter toward the front of the car and then pull the filter straight out.



5. Replace the filter by sliding it back in, reattaching both retaining clips and closing the grille flap.
6. Replace the engine compartment rear seal.
7. Close the engine hood.

For the type of filter to use, see “Normal Maintenance Replacement Parts” in the Index.

Automatic Transmission Fluid

It is not necessary to check the transmission fluid level. A transmission fluid leak is the only reason for fluid loss. If a leak occurs, take your vehicle to the dealership service department and have it repaired as soon as possible. You may also have your fluid level checked by your dealer or service center when you have your oil changed.

Change both the fluid and filter every 50,000 miles (83 000 km) if the vehicle is mainly driven under one or more of these conditions:

- In heavy city traffic where the outside temperature regularly reaches 90°F (32°C) or higher.
- In hilly or mountainous terrain.
- When doing frequent trailer towing.
- Uses such as found in taxi, police or delivery service.

If you do not use your vehicle under any of these conditions, the fluid and filter do not require changing.

NOTICE:

We recommend you use only fluid labeled **DEXRON®-III**, because fluid with that label is made especially for your automatic transmission. Damage caused by fluid other than **DEXRON®-III** is not covered by your new vehicle warranty.

Rear Axle

When to Check Lubricant

Refer to the Maintenance Schedule to determine how often to check the lubricant. See “Periodic Maintenance Inspections” and “Scheduled Maintenance Services” in the Maintenance Schedule booklet.

How to Check Lubricant

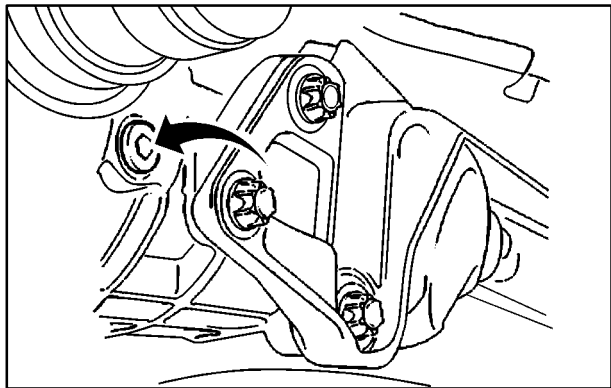

If the level is below the bottom of the filler plug hole, you'll need to add some lubricant. Add enough lubricant to raise the level to the bottom of the filler plug hole.

What to Use

Refer to the Maintenance Schedule to determine what kind of lubricant to use. See “Recommended Fluids and Lubricants” in the Maintenance Schedule booklet.

Surge Tank Pressure Cap

NOTICE:

The surge tank cap is a 14 psi (97 kPa) pressure-type cap and must be tightly installed to prevent coolant loss and possible engine damage from overheating.

If the surge tank pressure cap needs to be replaced, a GM cap is recommended.

Thermostat

Engine coolant temperature is controlled by a thermostat in the engine coolant system. The thermostat stops the flow of coolant through the radiator until the coolant reaches a preset temperature.

If the thermostat needs to be replaced, a GM thermostat is recommended.

Engine Coolant

The cooling system in your vehicle is filled with DEX-COOL[®] engine coolant. This coolant is designed to remain in your vehicle for 5 years or 150,000 miles (240 000 km), whichever occurs first, if you add only DEX-COOL[®] extended life coolant.

The following explains your cooling system and how to add coolant when it is low. If you have a problem with engine overheating, see “Engine Overheating” in the Index.

A 50/50 mixture of clean, drinkable water and DEX-COOL[®] coolant will:

- Give freezing protection down to -34°F (-37°C).
- Give boiling protection up to 265°F (129°C).
- Protect against rust and corrosion.
- Help keep the proper engine temperature.
- Let the warning lights and gages work as they should.

NOTICE:

When adding coolant, it is important that you use only DEX-COOL[®] (silicate-free) coolant.

If coolant other than DEX-COOL is added to the system, premature engine, heater core or radiator corrosion may result. In addition, the engine coolant will require change sooner -- at 30,000 miles (50 000 km) or 24 months, whichever occurs first. Damage caused by the use of coolant other than DEX-COOL[®] is not covered by your new vehicle warranty.

What to Use

Use a mixture of one-half *clean, drinkable water* and one-half DEX-COOL[®] coolant which won't damage aluminum parts. If you use this coolant mixture, you don't need to add anything else.

 **CAUTION:**

Adding only plain water to your cooling system can be dangerous. Plain water, or some other liquid like alcohol, can boil before the proper coolant mixture will. Your vehicle's coolant warning system is set for the proper coolant mixture. With plain water or the wrong mixture, your engine could get too hot but you wouldn't get the overheat warning. Your engine could catch fire and you or others could be burned. Use a 50/50 mixture of clean, drinkable water and DEX-COOL[®] coolant.

NOTICE:

If you use an improper coolant mixture, your engine could overheat and be badly damaged. The repair cost wouldn't be covered by your warranty. Too much water in the mixture can freeze and crack the engine, radiator, heater core and other parts.

If you have to add coolant more than four times a year, have your dealer check your cooling system.

NOTICE:

If you use the proper coolant, you don't have to add extra inhibitors or additives which claim to improve the system. These can be harmful.

Checking Coolant



The surge tank is located behind the air cleaner on the passenger's side of the engine.

The cooling system when hot is under a lot of pressure. If the low coolant warning light on the instrument panel appears, you will need to add coolant.

⚠ CAUTION:

Turning the surge tank pressure cap when the engine and radiator are hot can allow steam and scalding liquids to blow out and burn you badly. Never turn the surge tank pressure cap -- even a little -- when the engine and radiator are hot.

The vehicle must be on a level surface. When your engine is cold, the coolant level should be at the KALT/COLD line (seam).

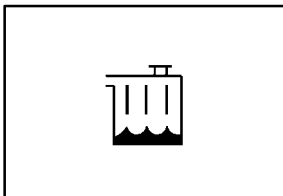

If the light comes on and stays on, it means you're low on engine coolant.

For more information, see “Low Coolant Warning Light” in the Index.

Adding Coolant

If you need more coolant, add the proper DEX-COOL[®] coolant mixture *at the surge tank*, but only when the engine is cool.

⚠ CAUTION:

You can be burned if you spill coolant on hot engine parts. Coolant contains ethylene glycol, and it will burn if the engine parts are hot enough. Don't spill coolant on a hot engine.

When replacing the pressure cap, make sure it is hand-tight.

Power Steering Fluid



The power steering fluid reservoir is located between the battery and the brake master cylinder on the driver's side of the engine.

When to Check Power Steering Fluid

It is not necessary to regularly check power steering fluid unless you suspect there is a leak in the system or you hear an unusual noise. A fluid loss in this system could indicate a problem. Have the system inspected and repaired.

How to Check Power Steering Fluid

When the engine compartment is cool, wipe the cap and the top of the reservoir clean, then unscrew the cap and wipe the dipstick with a clean rag. Replace the cap and completely tighten it. Then remove the cap again and look at the fluid level on the dipstick.

The level should be at the full mark. There are two lines on the dipstick. The top line is the "full" mark and the bottom line is the "add" line (which means that fluid should be added). If necessary, add only enough fluid to bring the level up to the full mark.

What to Use

To determine what kind of fluid to use, see "Recommended Fluids and Lubricants" in the Maintenance Schedule booklet. Always use the proper fluid. Failure to use the proper fluid can cause leaks and damage hoses and seals.

Windshield Washer Fluid

What to Use

When you need windshield washer fluid, be sure to read the manufacturer's instructions before use. If you will be operating your vehicle in an area where the temperature may fall below freezing, use a fluid that has sufficient protection against freezing.

Adding Washer Fluid



The windshield washer fluid reservoir is located behind the front grille on the driver's side of the engine.

Open the cap with the washer symbol on it. Add washer fluid until the tank is full.

NOTICE:

- **When using concentrated washer fluid, follow the manufacturer's instructions for adding water.**
- **Don't mix water with ready-to-use washer fluid. Water can cause the solution to freeze and damage your washer fluid tank and other parts of the washer system. Also, water doesn't clean as well as washer fluid.**
- **Fill your washer fluid tank only three-quarters full when it's very cold. This allows for expansion if freezing occurs, which could damage the tank if it is completely full.**
- **Don't use engine coolant (antifreeze) in your windshield washer. It can damage your washer system and paint.**

Brakes

Brake Fluid



Your brake master cylinder reservoir is on the driver's side of the engine compartment. It is filled with DOT-3 brake fluid.

There are only two reasons why the brake fluid level in the reservoir might go down. The first is that the brake fluid goes down to an acceptable level during normal brake lining wear. When new linings are put in, the fluid level goes back up. The other reason is that fluid is leaking out of the brake system. If it is, you should have your brake system fixed, since a leak means that sooner or later your brakes won't work well, or won't work at all.

So, it isn't a good idea to "top off" your brake fluid. Adding brake fluid won't correct a leak. If you add fluid when your linings are worn, then you'll have too much fluid when you get new brake linings. You should add (or remove) brake fluid, as necessary, only when work is done on the brake hydraulic system.

CAUTION:

If you have too much brake fluid, it can spill on the engine. The fluid will burn if the engine is hot enough. You or others could be burned, and your vehicle could be damaged. Add brake fluid only when work is done on the brake hydraulic system.

When your brake fluid falls to a low level, your brake warning light will come on. See “Brake System Warning Light” in the Index.

What to Add

When you do need brake fluid, use only DOT-3 brake fluid. Use new brake fluid from a sealed container only. Refer to “Recommended Fluids and Lubricants” in the Maintenance Schedule booklet.

Always clean the brake fluid reservoir cap and the area around the cap before removing it. This will help keep dirt from entering the reservoir.



CAUTION:

With the wrong kind of fluid in your brake system, your brakes may not work well, or they may not even work at all. This could cause a crash. Always use the proper brake fluid.

NOTICE:

- **Using the wrong fluid can badly damage brake system parts. For example, just a few drops of mineral-based oil, such as engine oil, in your brake system can damage brake system parts so badly that they’ll have to be replaced. Don’t let someone put in the wrong kind of fluid.**
- **If you spill brake fluid on your vehicle’s painted surfaces, the paint finish can be damaged. Be careful not to spill brake fluid on your vehicle. If you do, wash it off immediately. See “Appearance Care” in the Index.**

Brake Wear

Your vehicle has four-wheel disc brakes.

Your vehicle has electronic wear sensors that let you know when the front brake pads are significantly worn and new pads are needed. The brake pad wear indicator light will come on and stay on when the brake pads are worn and need to be replaced. (See “Brake Pad Wear Indicator Light” in the Index.)

 **CAUTION:**

The brake pad wear indicator light means that soon your brakes won't work well. That could lead to an accident. When the brake pad wear indicator light comes on and stays on, have your vehicle serviced.

NOTICE:

Continuing to drive with worn-out brake pads could result in costly brake repair.

Some driving conditions or climates may cause a brake squeal when the brakes are first applied or lightly applied. This does not mean something is wrong with your brakes.

Properly torqued wheel bolts are necessary to help prevent brake pulsation. When tires are rotated, inspect brake pads for wear and evenly torque wheel bolts in the proper sequence to GM specifications.

Brake linings should always be replaced as complete axle sets.

See "Brake System Inspection" in the Maintenance Schedule booklet under Part C "Periodic Maintenance Inspections."

Brake Pedal Travel

See your dealer if the brake pedal does not return to normal height, or if there is a rapid increase in pedal travel. This could be a sign of brake trouble.

Brake Adjustment

Every time you apply the brakes, with or without the vehicle moving, your brakes adjust for wear.

Replacing Brake System Parts

The braking system on a vehicle is complex. Its many parts have to be of top quality and work well together if the vehicle is to have really good braking. Your vehicle was designed and tested with top-quality GM brake parts. When you replace parts of your braking system -- for example, when your brake linings wear down and you have to have new ones put in -- be sure you get new approved GM replacement parts. If you don't, your brakes may no longer work properly. For example, if someone puts in brake linings that are wrong for your vehicle, the balance between your front and rear brakes can change -- for the worse. The braking performance you've come to expect can change in many other ways if someone puts in the wrong replacement brake parts.

Battery

Your new vehicle comes with an ACDelco Freedom[®] battery. When it's time for a new battery, we recommend an ACDelco Freedom battery. Get one that has the replacement number shown on the original battery's label.

CAUTION:

Batteries have acid that can burn you and gas that can explode. You can be badly hurt if you aren't careful. See "Jump Starting" in the Index for tips on working around a battery without getting hurt.

After a power loss, such as disconnecting the battery or removing the MaxiFuses[®] in the power distribution fuse block, the following steps must be performed to calibrate the Electronic Throttle Control. If this is not done, the engine will not run properly.

1. Turn the ignition key to RUN . Do not start the engine.
2. Leave the ignition in RUN for at least three minutes so that the electronic throttle control will cycle and re-learn its home position.
3. Turn the ignition to OFF.
4. Start and run the engine for at least 30 seconds.

Also, for your audio system, see "Theft-Deterrent Feature" in the Index.

Bulb Replacement

For any bulb changing procedure not listed in this section, contact your dealer service department.

For bulb types, see “Replacement Bulbs” in the Index.

Halogen Bulbs

CAUTION:

Halogen bulbs have pressurized gas inside and can burst if you drop or scratch the bulb. You or others could be injured. Be sure to read and follow the instructions on the bulb package.

Headlamps



1. With a screwdriver, unscrew the fastener on the headlamp cover and then remove the cover to gain access to the headlamp bulbs. Note that the inner bulb is for the high-beam headlamp and the outer bulb is for the low-beam headlamp.



2. Remove the black rubber cap that protects the bulb area.



3. Remove the plug connector from the bulb.

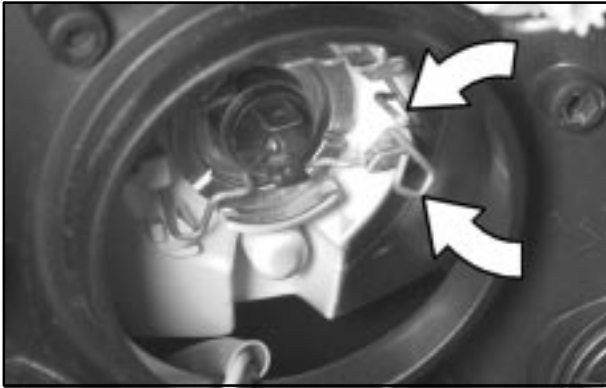

4. Squeeze the retaining clip together and then pull away from the bulb assembly.



5. Pull the bulb out and then replace.

Headlamp Aiming

If your vehicle is damaged in an accident, the headlamp aim may be affected. Aim adjustment to the low beam may be necessary if it is difficult to see lane markers (for horizontal aim), or if oncoming drivers flash their high beams at you (for vertical aim). If you believe your headlamps need to be re-aimed, we recommend that you take your vehicle to the dealer for service. However, it is possible for you to re-aim your headlamps by following the procedure in the service manual for your vehicle.

NOTICE:

To make sure your headlamps are aimed properly, read all instructions before beginning. Failure to follow these instructions could cause damage to headlamp parts.

Front Turn Signal Lamp



1. With a screwdriver, unscrew the fastener on the headlamp cover and then remove it to access the turn signal lamps.



2. On the outboard side of each low-beam headlamp, you will find the turn signal bulbs. Turn the lamp assembly counterclockwise to remove.



3. Pull the bulb out to replace and then reassemble.

Center High-Mounted Stoplamp (CHMSL)

The CHMSL is equipped with high-durability illumination. If a bulb problem does occur, see your dealer for assistance.

Taillamp and Rear Turn Signal Lamp

1. Open the trunk to access the lamp housing.
2. Depending on which outer bulb needs replacing, open either the spare tire cover on the driver's side or the storage compartment on the passenger's side to access the bulbs.



3. Press the gray tab on the lamp housing up as you pull the black tab on the lamp housing away from the vehicle. Continue to pull the lamp housing straight out to access the bulbs.

4. To remove the bulb, turn it counterclockwise. When you replace the bulb, you need to push it in and twist it clockwise into place.
5. Replace the lamp housing by snapping it back into place.

Note: The taillamp assembly running across the rear deck lid is equipped with high-durability illumination. If a bulb problem does occur, see your dealer for assistance.

Wiper Blade Replacement

Windshield wiper blades should be inspected at least twice a year for wear or cracking. See “Wiper Blade Check” in the Maintenance Schedule booklet under Part B “Owner Checks and Services” for more information.

It’s a good idea to clean or replace the wiper blade assembly on a regular basis or when worn. For proper windshield wiper blade type, see “Normal Maintenance Replacement Parts” later in this section.

To replace the wiper blade assembly:

1. Pull the windshield wiper assembly away from the windshield.
2. Lift the wiper blade assembly up so it is in a “T” shaped position. You should be able to see a tab.
3. Squeeze the tab together and pull the wiper blade assembly down enough to release it from the “J” hooked end of the wiper arm. Slide the assembly away from the arm.
4. Replace the blade.





5. To reinstall the wiper blade assembly, slide it over the wiper arm to engage the “J” hooked end on the wiper blade assembly. Pull up on the assembly to lock it into place.

Tires

Your new vehicle comes with high-quality tires made by a leading tire manufacturer. If you ever have questions about your tire warranty and where to obtain service, see your Catera Warranty booklet for details.

CAUTION:

Poorly maintained and improperly used tires are dangerous.

- **Overloading your tires can cause overheating as a result of too much friction. You could have an air-out and a serious accident. See “Loading Your Vehicle” in the Index.**

CAUTION: (Continued)

CAUTION: (Continued)

- **Underinflated tires pose the same danger as overloaded tires. The resulting accident could cause serious injury. Check all tires frequently to maintain the recommended pressure. Tire pressure should be checked when your tires are cold.**
- **Overinflated tires are more likely to be cut, punctured or broken by a sudden impact -- such as when you hit a pothole. Keep tires at the recommended pressure.**
- **Worn, old tires can cause accidents. If your tread is badly worn, or if your tires have been damaged, replace them.**

See “Inflation -- Tire Pressure” in this section for inflation pressure adjustment for higher speed driving.

Inflation -- Tire Pressure

The Tire-Loading Information label, which is located on the rear edge of the driver’s door, shows the correct inflation pressures for your tires when they’re cold. “Cold” means your vehicle has been sitting for at least three hours or driven no more than 1 mile (1.6 km).

If you’ll be driving at speeds higher than 100 mph (160 km/h) where it is legal, raise the cold inflation pressure of each tire to 37 psi (250 kPa). When you end this very high-speed driving, reduce the cold inflation pressures to those listed on the Tire-Loading Information label.

NOTICE:

Don’t let anyone tell you that underinflation or overinflation is all right. It’s not. If your tires don’t have enough air (underinflation), you can get the following:

- **Too much flexing**
- **Too much heat**

NOTICE: (Continued)

NOTICE: (Continued)

- **Tire overloading**
- **Bad wear**
- **Bad handling**
- **Bad fuel economy.**

If your tires have too much air (overinflation), you can get the following:

- **Unusual wear**
- **Bad handling**
- **Rough ride**
- **Needless damage from road hazards.**

When to Check

Check your tires once a month or more. Also, check the tire pressure of the spare tire.

How to Check

Use a good quality pocket-type gage to check tire pressure. You can't tell if your tires are properly inflated simply by looking at them. Radial tires may look properly inflated even when they're underinflated.

Be sure to put the valve caps back on the valve stems. They help prevent leaks by keeping out dirt and moisture.

Tire Inspection and Rotation

Tires should be rotated at 5,000 miles (8 000 km) and then every 10,000 miles (16 000 km) thereafter. Any time you notice unusual wear, rotate your tires as soon as possible and check wheel alignment. Also check for damaged tires or wheels. See "When It's Time for New Tires" and "Wheel Replacement" later in this section for more information.

The purpose of regular rotation is to achieve more uniform wear for all tires on the vehicle. The first rotation is the most important. See "Scheduled Maintenance Services" in the Maintenance Schedule booklet for scheduled rotation intervals.

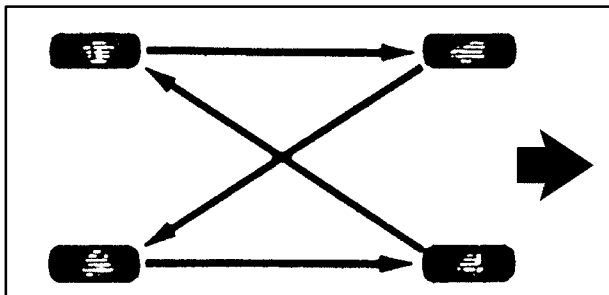

When rotating your tires, always use the correct rotation pattern shown here.

After the tires have been rotated, adjust the front and rear inflation pressures as shown on the Tire-Loading Information label. Make certain that all wheel bolts are properly tightened. See “Wheel Bolt Torque” in the Index.

CAUTION:

Rust or dirt on a wheel, or on the parts to which it is fastened, can make wheel studs become loose after a time. The wheel could come off and cause an accident. When you change a wheel, remove any rust or dirt from places where the wheel attaches to the vehicle. In an emergency, you can use a cloth or a paper towel to do this; but be sure to use a scraper or wire brush later, if you need to, to get all the rust or dirt off. (See “Changing a Flat Tire” in the Index.)

When It's Time for New Tires

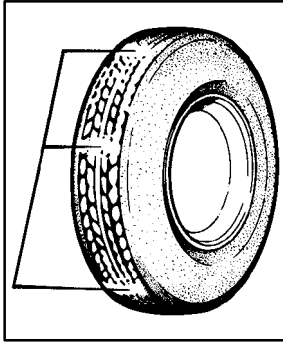

One way to tell when it's time for new tires is to check the treadwear indicators, which will appear when your tires have only 1/16 inch (1.6 mm) or less of tread remaining.

You need a new tire if any of the following statements are true:

- You can see the indicators at three or more places around the tire.
- You can see cord or fabric showing through the tire's rubber.
- The tread or sidewall is cracked, cut or snagged deep enough to show cord or fabric.

- The tire has a bump, bulge or split.
- The tire has a puncture, cut or other damage that can't be repaired well because of the size or location of the damage.

Buying New Tires

To find out what kind and size of tires you need, look at the Tire-Loading Information label.

The tires installed on your vehicle when it was new had a Tire Performance Criteria Specification (TPC Spec) number on each tire's sidewall. When you get new tires, get ones with that same TPC Spec number. That way your vehicle will continue to have tires that are designed to give proper endurance, handling, speed rating, traction, ride and other things during normal service on your vehicle. If your tires have an all-season tread design, the TPC number will be followed by an "MS" (for mud and snow).

If you ever replace your tires with those not having a TPC Spec number, make sure they are the same size, load range, speed rating and construction type (bias, bias-belted or radial) as your original tires.

 **CAUTION:**

Mixing tires could cause you to lose control while driving. If you mix tires of different sizes or types (radial and bias-belted tires), the vehicle may not handle properly, and you could have a crash. Using tires of different sizes may also cause damage to your vehicle. Be sure to use the same size and type tires on all wheels.

 **CAUTION:**

If you use bias-ply tires on your vehicle, the wheel rim flanges could develop cracks after many miles of driving. A tire and/or wheel could fail suddenly, causing a crash. Use only radial-ply tires with the wheels on your vehicle.

Uniform Tire Quality Grading

The following information relates to the system developed by the United States National Highway Traffic Safety Administration, which grades tires by treadwear, traction and temperature performance. (This applies only to vehicles sold in the United States.) The grades are molded on the sidewalls of most passenger car tires. The Uniform Tire Quality Grading system does not apply to deep tread, winter-type snow tires, space-saver or temporary use spare tires, tires with nominal rim diameters of 10 to 12 inches (25 to 30 cm), or to some limited-production tires.

While the tires available on General Motors passenger cars and light trucks may vary with respect to these grades, they must also conform to Federal safety requirements and additional General Motors Tire Performance Criteria (TPC) standards.

Treadwear

The treadwear grade is a comparative rating based on the wear rate of the tire when tested under controlled conditions on a specified government test course. For example, a tire graded 150 would wear one and a half (1 1/2) times as well on the government course as a tire graded 100. The relative performance of tires depends upon the actual conditions of their use, however, and may depart significantly from the norm due to variations in driving habits, service practices and differences in road characteristics and climate.

Traction -- AA, A, B, C

The traction grades, from highest to lowest, are AA, A, B, and C. Those grades represent the tire's ability to stop on wet pavement as measured under controlled conditions on specified government test surfaces of asphalt and concrete. A tire marked C may have poor traction performance. Warning: The traction grade assigned to this tire is based on straight-ahead braking traction tests, and does not include acceleration, cornering, hydroplaning, or peak traction characteristics.

Temperature -- A, B, C

The temperature grades are A (the highest), B, and C, representing the tire's resistance to the generation of heat and its ability to dissipate heat when tested under controlled conditions on a specified indoor laboratory test wheel. Sustained high temperature can cause the material of the tire to degenerate and reduce tire life, and excessive temperature can lead to sudden tire failure. The grade C corresponds to a level of performance which all passenger car tires must meet under the Federal Motor Vehicle Safety Standard No. 109. Grades B and A represent higher levels of performance on the laboratory test wheel than the minimum required by law.

Warning: The temperature grade for this tire is established for a tire that is properly inflated and not overloaded. Excessive speed, underinflation, or excessive loading, either separately or in combination, can cause heat buildup and possible tire failure.

Wheel Alignment and Tire Balance

The wheels on your vehicle were aligned and balanced carefully at the factory to give you the longest tire life and best overall performance.

Scheduled wheel alignment and wheel balancing are not needed. However, if you notice unusual tire wear or your vehicle pulling one way or the other, the alignment may need to be reset. If you notice your vehicle vibrating when driving on a smooth road, your wheels may need to be rebalanced.

Wheel Replacement

Replace any wheel that is bent, cracked, or badly rusted or corroded. If wheel bolts keep coming loose, the wheel and wheel bolts should be replaced. If the wheel leaks air, replace it (except some aluminum wheels, which can sometimes be repaired). See your dealer if any of these conditions exist.

Your dealer will know the kind of wheel you need.

Each new wheel should have the same load-carrying capacity, diameter, width, offset and be mounted the same way as the one it replaces.

If you need to replace any of your wheels or wheel bolts, replace them only with new GM original equipment parts. This way, you will be sure to have the right wheel and wheel bolts for your vehicle.



CAUTION:

Using the wrong replacement wheels and wheel bolts on your vehicle can be dangerous. It could affect the braking and handling of your vehicle, make your tires lose air and make you lose control. You could have a collision in which you or others could be injured. Always use the correct wheel and wheel bolts for replacement.

NOTICE:

The wrong wheel can also cause problems with bearing life, brake cooling, speedometer or odometer calibration, headlamp aim, bumper height, vehicle ground clearance and tire or tire chain clearance to the body and chassis.

See “Changing a Flat Tire” in the Index for more information.

Used Replacement Wheels **CAUTION:**

Putting a used wheel on your vehicle is dangerous. You can't know how it's been used or how far it's been driven. It could fail suddenly and cause an accident. If you have to replace a wheel, use a new GM original equipment wheel.

Tire Chains**NOTICE:**

Use tire chains only where legal and only when you must. Use only SAE Class “S” type chains that are the proper size for your tires. Install them on the rear tires and tighten them as tightly as possible with the ends securely fastened. Drive slowly and follow the chain manufacturer's instructions. If you can hear the chains contacting your vehicle, stop and retighten them. If the contact continues, slow down until it stops. Driving too fast or spinning the wheels with chains on will damage your vehicle.

Appearance Care

Remember, cleaning products can be hazardous. Some are toxic. Others can burst into flame if you strike a match or get them on a hot part of the vehicle. Some are dangerous if you breathe their fumes in a closed space. When you use anything from a container to clean your vehicle, be sure to follow the manufacturer's warnings and instructions. And always open your doors or windows when you're cleaning the inside.

Never use these to clean your vehicle:

- Gasoline
- Benzene
- Naphtha
- Carbon Tetrachloride
- Acetone
- Paint Thinner
- Turpentine
- Lacquer Thinner
- Nail Polish Remover

They can all be hazardous -- some more than others -- and they can all damage your vehicle, too.

Don't use any of these unless this manual says you can. In many uses, these will damage your vehicle:

- Alcohol
- Laundry Soap
- Bleach
- Reducing Agents

Cleaning the Inside of Your Vehicle

Use a vacuum cleaner often to get rid of dust and loose dirt. Wipe vinyl, leather, plastic and painted surfaces with a clean, damp cloth.

Cleaning of Fabric/Carpet

Your dealer has two cleaners, Multi-Purpose Interior Cleaner and Capture Non-Solvent Dry Spot and Soil Remover for cleaning fabric and carpet. They will clean normal spots and stains very well. You can get GM-approved cleaning products from your dealer. (See "Appearance Care and Materials" in the Index.)

Here are some cleaning tips:

- Always read the instructions on the cleaner label.
- Clean up stains as soon as you can -- before they set.
- Carefully scrape off any excess stain.
- Use a clean cloth or sponge, and change to a clean area often. A soft brush may be used if stains are stubborn.
- If a ring forms on fabric after spot cleaning, clean the entire area immediately or it will set.

Cleaning Vinyl

Use warm water and a clean cloth.

- Rub with a clean, damp cloth to remove dirt. You may have to do it more than once.
- Things like tar, asphalt and shoe polish will stain if you don't get them off quickly. Use a clean cloth and a vinyl/leather cleaner. See your dealer for this product.

Cleaning Leather

Use a soft cloth with lukewarm water and a mild soap or saddle soap and wipe dry with a soft cloth. Then, let the leather dry naturally. Do not use heat to dry.

- For stubborn stains, use a leather cleaner. See your dealer for this product.
- *Never* use oils, varnishes, solvent-based or abrasive cleaners, furniture polish or shoe polish on leather.
- Soiled or stained leather should be cleaned immediately. If dirt is allowed to work into the finish, it can harm the leather.

Cleaning the Top of the Instrument Panel

Use only mild soap and water to clean the top surfaces of the instrument panel. Sprays containing silicones or waxes may cause annoying reflections in the windshield and even make it difficult to see through the windshield under certain conditions.

Cleaning Interior Plastic Components

Use only a mild soap and water solution on a soft cloth or sponge. Commercial cleaners may affect the surface finish.

Cleaning Speaker Covers

Vacuum around a speaker cover gently, so that the speaker won't be damaged. Clean spots with just water and mild soap.

Care of Safety Belts

Keep belts clean and dry.

CAUTION:

Do not bleach or dye safety belts. If you do, it may severely weaken them. In a crash, they might not be able to provide adequate protection. Clean safety belts only with mild soap and lukewarm water.

Cleaning Glass Surfaces

Glass should be cleaned often. GM Glass Cleaner or a liquid household glass cleaner will remove normal tobacco smoke and dust films on interior glass. (See "Appearance Care and Materials" in the Index.)

Don't use abrasive cleaners on glass, because they may cause scratches. Avoid placing decals on the inside rear window, since they may have to be scraped off later. If abrasive cleaners are used on the inside of the rear window, an electric defogger element may be damaged. Any temporary license should not be attached across the defogger grid.

Cleaning the Outside of the Windshield and Wiper Blades

If the windshield is not clear after using the windshield washer, or if the wiper blade chatters when running, wax, sap or other material may be on the blade or windshield.

Clean the outside of the windshield with GM Windshield Cleaner, Bon Ami[®] Powder (non-scratching glass cleaning powder), GM Part No. 1050011. The windshield is clean if beads do not form when you rinse it with water.

Grime from the windshield will stick to the wiper blades and affect their performance. Clean the blade by wiping vigorously with a cloth soaked in full-strength windshield washer solvent. Then rinse the blade with water.

Check the wiper blades and clean them as necessary; replace blades that look worn.

Weatherstrips

Silicone grease on weatherstrips will make them last longer, seal better, and not stick or squeak. Apply silicone grease with a clean cloth at least every six months. During very cold, damp weather more frequent application may be required. (See “Recommended Fluids and Lubricants” in the Maintenance Schedule booklet.)

Cleaning the Outside of Your Vehicle

The paint finish on your vehicle provides beauty, depth of color, gloss retention and durability.

Washing Your Vehicle

The best way to preserve your vehicle’s finish is to keep it clean by washing it often with lukewarm or cold water.

Don’t wash your vehicle in the direct rays of the sun. Use a car washing soap. Don’t use strong soaps or chemical detergents. Be sure to rinse the vehicle well, removing all soap residue completely. You can get GM-approved cleaning products from your dealer. (See “Appearance Care and Materials” in the Index.) Don’t use cleaning agents that are petroleum based, or that contain acid or abrasives. All cleaning agents should be flushed promptly and not allowed to dry on the surface, or they could stain. Dry the finish with a soft, clean chamois or an all-cotton towel to avoid surface scratches and water spotting.

High pressure car washes may cause water to enter your vehicle.

Cleaning Exterior Lamps/Lenses

Use lukewarm or cold water, a soft cloth and a car washing soap to clean exterior lamps and lenses. Follow instructions under “Washing Your Vehicle.”

Finish Care

Occasional waxing or mild polishing of your vehicle by hand may be necessary to remove residue from the paint finish. You can get GM-approved cleaning products from your dealer. (See “Appearance Care and Materials” in the Index.)

Your vehicle has a “basecoat/clearcoat” paint finish. The clearcoat gives more depth and gloss to the colored basecoat. Always use waxes and polishes that are non-abrasive and made for a basecoat/clearcoat paint finish.

NOTICE:

Machine compounding or aggressive polishing on a basecoat/clearcoat paint finish may dull the finish or leave swirl marks.

Foreign materials such as calcium chloride and other salts, ice melting agents, road oil and tar, tree sap, bird droppings, chemicals from industrial chimneys, etc., can damage your vehicle’s finish if they remain on painted surfaces. Wash the vehicle as soon as possible. If necessary, use non-abrasive cleaners that are marked safe for painted surfaces to remove foreign matter.

Exterior painted surfaces are subject to aging, weather and chemical fallout that can take their toll over a period of years. You can help to keep the paint finish looking new by keeping your vehicle garaged or covered whenever possible.

Cleaning Aluminum or Chrome-Plated Wheels (If Equipped)

Keep your wheels clean using a soft clean cloth with mild soap and water. Rinse with clean water. After rinsing thoroughly, dry with a soft clean towel. A wax may then be applied.

The surface of these wheels is similar to the painted surface of your Catera. Don't use strong soaps, chemicals, abrasive polishes, abrasive cleaners, cleaners with acid or abrasive cleaning brushes on them because you could damage the surface. Do not use chrome polish on any wheels other than chrome-plated wheels.

Use chrome polish only on chrome-plated wheels, but avoid any painted surface of the wheel, and buff off immediately after application.

Don't take your vehicle through an automatic car wash that has silicon carbide tire cleaning brushes. These brushes can also damage the surface of these wheels.

Cleaning Tires

To clean your tires, use a stiff brush with a tire cleaner.

NOTICE:

When applying a tire dressing always take care to wipe off any overspray or splash from all painted surfaces on the body or wheels of the vehicle. Petroleum-based products may damage the paint finish and tires.

Sheet Metal Damage

If your vehicle is damaged and requires sheet metal repair or replacement, make sure the body repair shop applies anti-corrosion material to the parts repaired or replaced to restore corrosion protection.

Finish Damage

Any stone chips, fractures or deep scratches in the finish should be repaired right away. Bare metal will corrode quickly and may develop into a major repair expense.

Minor chips and scratches can be repaired with touch-up materials available from your dealer or other service outlets. Larger areas of finish damage can be corrected in your dealer's body and paint shop.

Underbody Maintenance

Chemicals used for ice and snow removal and dust control can collect on the underbody. If these are not removed, accelerated corrosion (rust) can occur on the underbody parts such as fuel lines, frame, floor pan and exhaust system even though they have corrosion protection.

At least every spring, flush these materials from the underbody with plain water. Clean any areas where mud and other debris can collect. Dirt packed in closed areas of the frame should be loosened before being flushed. Your dealer or an underbody car washing system can do this for you.

Chemical Paint Spotting

Some weather and atmospheric conditions can create a chemical fallout. Airborne pollutants can fall upon and attack painted surfaces on your vehicle. This damage can take two forms: blotchy, ringlet-shaped discolorations, and small irregular dark spots etched into the paint surface.

Although no defect in the paint job causes this, Cadillac will repair, at no charge to the owner, the surfaces of new vehicles damaged by this fallout condition within 12 months or 12,000 miles (20 000 km) of purchase, whichever occurs first.

GM Vehicle Care/Appearance Materials

PART NUMBER	SIZE	DESCRIPTION	USAGE
994954	23 in. x 25 in.	Polishing Cloth – Wax Treated	Exterior polishing cloth
1050172	16 oz. (0.473 L)	Tar and Road Oil Remover	Removes tar, road oil and asphalt
1050173	16 oz. (0.473 L)	Chrome Cleaner and Polish	Use on chrome, stainless steel, nickel, copper and brass
1050174	16 oz. (0.473 L)	White Sidewall Tire Cleaner	Removes soil and black marks from whitewalls
1050214	32 oz. (0.946 L)	Vinyl Cleaner	Cleans vinyl tops, upholstery and convertible tops
1050427	23 oz. (0.680 L)	Glass Cleaner	Removes dirt, grime, smoke and fingerprints
1052918**	8 oz. (0.237 L)	Armor All™ Protectant	Protects leather, wood, acrylics, Plexiglas™, plastic, rubber and vinyl
1052925	16 oz. (0.473 L)	Multi-Purpose Interior Cleaner	Cleans carpets, seats, interior trim, door panels and floor mats
1052929	16 oz. (0.473 L)	Wheel Cleaner	Spray on and rinse with water
1052930	8 oz. (0.237 L)	Capture Dry Spot Remover	Attracts, absorbs and removes soils on fabric
12345721	2.5 sq. ft.	Synthetic Chamois	Shines vehicle without scratching
12345725	12 oz. (0.354 L)	Silicone Tire Shine	Spray on tire shine
12377964*	16 oz. (0.473 L)	Finish Enhancer	Removes dust, fingerprints and surface contaminants
12377966*	16 oz. (0.473 L)	Cleaner Wax	Removes light scratches and oxidation and protects finish
12377984*	16 oz. (0.473 L)	Surface Cleaner	Removes contaminants, blemishes and swirl marks

See your General Motors Parts Department for these products.

See “Recommended Fluids and Lubricants” in the Maintenance Schedule booklet.

* For exterior use only.

** Not recommended for use on instrument panels.

Vehicle Identification Number (VIN)

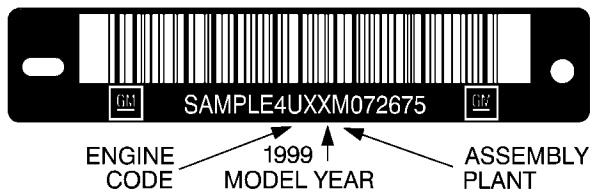

This is the legal identifier for your vehicle. It appears on a plate in the front corner of the instrument panel, on the driver's side. You can see it if you look through the windshield from outside your vehicle. The VIN also appears on the Vehicle Certification and Service Parts labels and the certificates of title and registration.

Engine Identification

The 8th character in your VIN is the engine code. This code will help you identify your engine, specifications and replacement parts.

Service Parts Identification Label

You'll find this label behind the passenger's side access panel in the trunk (the panel that covers the trunk-mounted CD changer). It's very helpful if you ever need to order parts. On this label is:

- your VIN,
- the model designation,
- paint information and
- a list of all production options and special equipment.

Be sure that this label is not removed from the vehicle.

Electrical System

Add-On Electrical Equipment

NOTICE:

Don't add anything electrical to your vehicle unless you check with your dealer first. Some electrical equipment can damage your vehicle and the damage wouldn't be covered by your warranty. Some add-on electrical equipment can keep other components from working as they should.

Your vehicle has an air bag system. Before attempting to add anything electrical to your vehicle, see “Servicing Your Air Bag-Equipped Vehicle” in the Index.

Headlamp Wiring

The headlamp wiring has several fuses which are powered by a MaxiFuse[®]. An electrical overload will cause the lamps to go on and off, or in some cases to remain off. If this happens, have the headlamp wiring checked right away.

Windshield Wiper Fuses

If the windshield wiper motor overheats due to heavy snow or ice, the wipers will stop until the motor cools. If the overload is caused by some electrical problem, be sure to have it fixed.

Power Windows and Other Power Options

Circuit breakers protect the power windows and other power accessories. When the current load is too heavy, the circuit breaker opens and closes, protecting the circuit until the problem is fixed or goes away.

Power Distribution Fuse Block

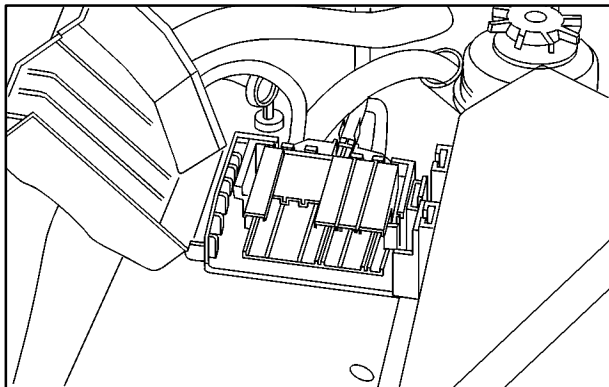

This fuse block is attached to the engine compartment relay center located on top of the battery. Simply lift the lid to open. If you have any questions about the power distribution fuse block, consult your dealer.

Note: If a power loss has occurred, such as disconnecting the battery or removing the MaxiFuses in the power distribution fuse block, there are steps that must be followed to calibrate the Electronic Throttle Control (ETC). If these steps are not done, the engine will not run properly. For information regarding these steps, see “Battery” earlier in this section.

Fuses and Circuit Breakers

The wiring circuits in your vehicle are protected from short circuits by a combination of fuses and circuit breakers. This greatly reduces the chance of fires caused by electrical problems.

Look at the silver-colored band inside the fuse. If the band is broken or melted, replace the fuse. Be sure you replace a bad fuse with a new one of the identical size and rating.

If you ever have a problem on the road and don't have a spare fuse, you can borrow one that has the same amperage. Pick some feature of your vehicle that you can get along without -- like the radio or cigarette lighter -- and use its fuse, if it is the correct amperage. Replace it as soon as you can.

There are two fuse blocks in your vehicle: the instrument panel fuse block and the engine compartment relay center.

Instrument Panel Fuse Block (Driver's Side)

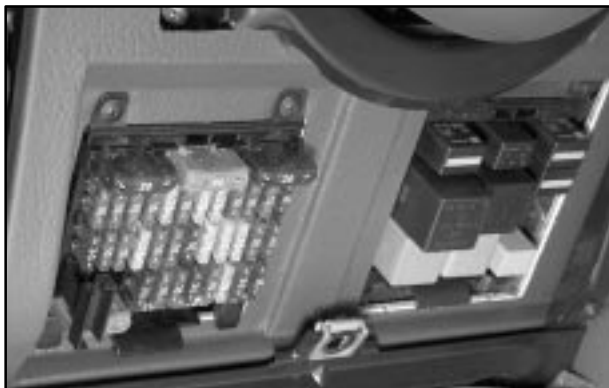

The fuse block is located below the steering wheel on the driver's side. Using a screwdriver, loosen the two trim fasteners under the trim panel and pull the trim panel away from the instrument panel to access.

33 HEATER BLOWER				34 RR WDO DEFOG				35 PWR SEAT			
21 HI BEAM LH	22 LO BEAM LH	23 PRK LP LH	24 CLAMP-W RESL	25 SUN ROOF	26 CLAMP 58	27 ALC	28 DOORLOCK	29 DOME LAMP	30 PRK LP RH	31 LO BEAM RH	32 HI BEAM RH
9 WIPER	10 CLAMP 15a	11 HTD MIRROR	12 HZD	13 O/S MIRROR	14 CLAMP 15	15 CLAMP 15 CRUISE	16 CIG	17 HORN	18 FUEL PUMP	19 ABS	20 HTDSEAT FRONT
				1 PWF	2 CLAMP 15 A/T	3 FLASHER	4 HTDSEAT REAR	5 CLAMP 30 A/T	6 AUDIO	7 PWR	8 RADIO BATT GRND

Fuse Usage

- 1 RH and LH Front Side Door Window Regulator Motor, LH Front Side Door Window Switch
- 2 Stoplamp Switch, Cruise Control Release Switch
- 3 Automatic Transmission Range Switch, Automatic Transmission Control Indicator, Power Steering Control Module, Hazard Warning Switch, Automatic Transmission Winter Mode Switch, Transmission Control Module (TCM)

Fuse	Usage	Fuse	Usage
4	RH and LH Rear Seat Cushion Heater Relay, Rear Sunshade Motor	14	Cellular Telephone, RH and LH Windshield Washer Nozzles, Driver and Passenger Heated Seat Switch, Heater and A/C Control, Heated Outside Rearview Mirror and Rear Window Defogger Relay
5	Transmission Control Module	15	Rear Suspension Leveling Air Compressor Relay, Instrument Cluster, Gage Cluster, Cruise Control Switch, Headlamp Switch, Multifunction Relay, Passenger and Driver Heated Seat Relay, BCM, Sunroof Actuator, Automatic Level Control Sensor, RH and LH Heated Rear Seat Switch, RH and LH Heated Rear Seat Cushion Relay, Driver Seat Adjuster Memory Module, LH Front Side Door Window Switch, Inside Rearview Mirror
6	Radio Speaker Amplifier		
7	RH and LH Rear Side Door Window Regulator Motor	16	Cigarette Lighter (Front and Console)
8	Headlamp Switch, Turn Signal Switch, Horn Relay, CD Changer, Multifunction Relay	17	Horn #1 and #2
9	Windshield Wiper Motor and Relay, Windshield Wiper and Windshield Washer Switch	18	Fuel Pump
10	Body Control Module (BCM), Heater Water Auxiliary Pump, Fan Control Relays, Auxiliary Water Pump Relay	19	Electronic Brake/Traction Control Module
11	Heater and A/C Control, RH and LH Outside Rearview Mirrors	20	Passenger and Driver Heated Seat Relay
12	Hazard Warning Switch, Instrument Cluster, Data Link Connector (DLC), Stoplamp Switch, Gage Cluster, Heater and A/C Control.	21	Daytime Running Lamp (DRL) Relay, LH High-Beam Headlamp Relay
13	Remote Control Outside Rearview Mirror Switch, A/C Compressor Relay, Coolant Fan Test Connector, A/C Load Switch		

Fuse	Usage	Fuse	Usage
22	Headlamp Switch, LH Low-Beam Headlamp	28	Door Lock Relay, OnStar [®] Connector
23	LH Parking Lamp and Turn Signal Lamps, LH Rear Sidemarkers Lamp, Multifunction Relay, LH Stoplamp and Taillamp	29	Multifunction Relay
24	Lifting Magnet, BCM, Gage Cluster	30	RH Parking Lamp and Turn Signal Lamp, RH Rear Sidemarkers Lamp, RH Stoplamp and Taillamp
25	Sunroof Actuator	31	RH Low-Beam Headlamp Turn Signal Switch
26	Headlamp Switch, RH and LH Front Sidemarkers Lamp, Middle Taillamp, RH and LH Rear License Plate Lamp, Radio, Automatic Transmission Control Indicator, Heater and A/C Control	32	RH High-Beam Headlamp Relay
27	Automatic Level Control Sensor, Rear Suspension Leveling Air Compressor and Relay	33	Blower Controller, A/C Compressor Relay
		34	Heated Rear Window Defogger Relay
		35	Passenger Seat Adjuster Switch, Driver Seat Adjuster Memory Module

Relay Box

I DRL	II ALC	VII PRK LP
III RR WDO DEFOG HTD MIRROR	IV FLASHER	VIII LO BEAM
V HI BEAM RH	VI HORN	IX
		X
		XI HI BEAM LH

Relay	Usage
I	Daytime Running Lamps
II	Automatic Level Control
III	Rear Window Defogger, Heated Mirrors
IV	Hazard Warning Flashers
V	High-Beam Headlamps II (RH)
VI	Horn
VII	Parking Lamps and Turn Signal Lamps
VIII	Low-Beam Headlamps
IX	Not Used
X	Not Used
XI	High-Beam Headlamps I (LH)

The relay box is located on the lower part of the instrument panel, to the right of the steering column.

Engine Compartment Relay Center



The relay center is located next to the battery on the driver's side of the engine. Lift the cover to access.

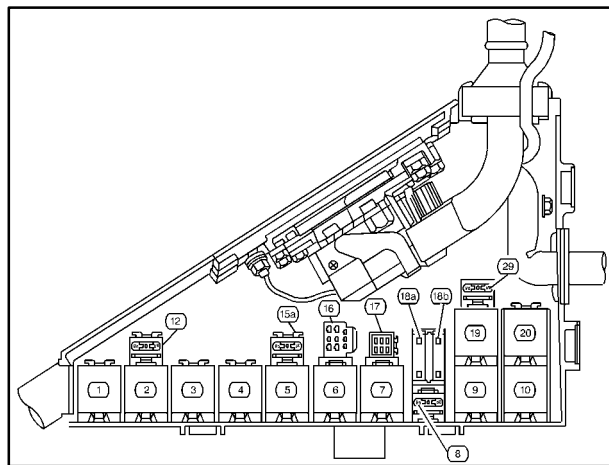

Fuse/Relay	Usage
1	Secondary Air Injection Pump (Relay K12)
2	Fan Control (Relay K67)
3	Auxiliary Water Pump (Relay K22)
4	Windshield Wiper Motor (Relay K8)
5	A/C Compressor Relay (K60)

Fuse/Relay	Usage
6	Fan Control Relay (K87)
7	Fan Control Relay (K26)
8	Fuse 50
9	Fan Control Relay (K28)
10	Engine Controls Power Relay (K43)
12	Fuse 40
15	Fuse 52
16	Connector C110
17	Coolant Fan Test Connector Fan Control
18	Fuse 42 (A), Fuse 49 (B)
19	Fan Control Relay (K52)
20	Fuel Pump Relay (K44)
29	Fuse 43

Replacement Bulbs

Application	Bulb Number
Composite Headlamps	
Inner High Beam	90512338
Outer Low Beam	90512338
Front Turn Signal Lamp	90487485
Rear Turn Signal Lamp and Taillamp	90002521

Capacities and Specifications

The following approximate capacities are given in English and metric conversions. Please refer to “Recommended Fluids and Lubricants” in the Maintenance Schedule booklet for more information.

Transmission	7.0 quarts (6.6 L)
Engine Crankcase	
Oil Change With Filter	6.0 quarts (5.75 L)
Engine Cooling System	10.57 quarts (10.0 L)
Fuel Tank	16.0 gallons (60.56 L)
R-134a Refrigerant	2.09 lbs. (0.95 kg)

NOTE: All capacities are approximate. When adding, be sure to fill to the approximate level, as recommended in this manual. Recheck fluid level after filling.

Wheel Bolt Torque

80 lb-ft (110 N·m)

Engine Specifications

Displacement	181 cubic inches (2 962 cc)
Type	3.0 L DOHC V6
VIN Engine Code	R
Horsepower	200 (bhp) @ 6000 rpm 149 (kW) @ 6000 rpm
Torque	192 (lb-ft) @ 3600 rpm 260 (N·m) @ 3600 rpm
Firing Order	1-2-3-4-5-6
Thermostat Starts To Open	198°F (92°C)

Air Conditioning Refrigerants

Not all air conditioning refrigerants are the same. If the air conditioning system in your vehicle needs refrigerant, be sure the proper refrigerant is used. If you're not sure, ask your dealer.

Normal Maintenance Replacement Parts

Air Filter Element	90509318
Fuel Filter Element	90542540
Engine Oil Filter	25010792
Passenger's Compartment Air Filter	90510338
Spark Plugs	90541059 (Bosch Plug = FLR9LTE)
Thermostat	90502201
Windshield Wiper Blades	9118382 (RH) 9118381 (LH)

Vehicle Dimensions

Wheel Base	107.5 inches (273.0 cm)
Length	194.0 inches (492.8 cm)
Height	56.4 inches (143.2 cm)
Width	70.3 inches (178.6 cm)
Front Tread	59.3 inches (150.6 cm)
Rear Tread	59.8 inches (152.0 cm)



Section 7 Customer Assistance Information

Here you will find out how to contact Cadillac if you need assistance. This section also tells you how to obtain service publications and how to report any safety defects.

7-2	Customer Satisfaction Procedure	7-10	Warranty Information
7-3	Customer Assistance for Text Telephone (TTY) Users	7-10	Reporting Safety Defects to the United States Government
7-4	Customer Assistance Offices	7-11	Reporting Safety Defects to the Canadian Government
7-5	GM Mobility Program for Persons with Disabilities	7-11	Reporting Safety Defects to General Motors
7-5	Roadside Service	7-11	Ordering Service and Owner Publications in Canada
7-7	Roadside Service for the Hearing or Speech Impaired		
7-8	Courtesy Transportation		
7-8	Transportation Options		

Customer Satisfaction Procedure



Your satisfaction and goodwill are important to your dealer and to Cadillac. Normally, any concerns with the sales transaction or the operation of your vehicle will be resolved by your dealer's sales or service departments. Sometimes, however, despite the best intentions of all concerned, misunderstandings can occur. If your concern has not been resolved to your satisfaction, the following steps should be taken:

STEP ONE -- Discuss your concern with a member of dealership management. Normally, concerns can be quickly resolved at that level. If the matter has already been reviewed with the sales, service or parts manager, contact the owner of the dealership or the general manager.

STEP TWO -- If after contacting a member of dealership management, it appears your concern cannot be resolved by the dealership without further help, contact the Cadillac Customer Assistance Center, 24 hours a day, by calling 1-800-458-8006. In Canada, contact GM of Canada Customer Communication Centre in Oshawa by calling 1-800-263-3777 (English) or 1-800-263-7854 (French).

We encourage you to call the toll-free number in order to give your inquiry prompt attention. Please have the following information available to give the Customer Assistance Representative:

- Vehicle Identification Number (This is available from the vehicle registration or title, or the plate at the top left of the instrument panel and visible through the windshield.)
- Dealership name and location
- Vehicle delivery date and present mileage

When contacting Cadillac, please remember that your concern will likely be resolved at a dealer's facility. That is why we suggest you follow Step One first if you have a concern.

STEP THREE -- Both General Motors and your dealer are committed to making sure you are completely satisfied with your new vehicle. However, if you continue to remain unsatisfied after following the procedure outlined in Steps One and Two, you must file with the GM/BBB Auto Line Program to enforce any additional rights you may have. Canadian owners refer to your Warranty and Owner Assistance Information booklet for information on the Canadian Motor Vehicle Arbitration Plan (CAMVAP).

The BBB Auto Line Program is an out of court program administered by the Council of Better Business Bureaus to settle automotive disputes regarding vehicle repairs or the interpretation of the New Vehicle Limited Warranty. Although you are required to resort to this informal dispute resolution program prior to filing any court action, use of the program is free of charge and your case will generally be heard within 40 days. If you do not agree with the decision given in your case, you may reject it and proceed with any other venue for relief available to you.

You may contact the BBB using the toll-free telephone number or write them at the following address:

BBB Auto Line
Council of Better Business Bureaus, Inc.
4200 Wilson Boulevard
Suite 800
Arlington, VA 22203-1804
Telephone: 1-800-955-5100

This program is available in all 50 states and the District of Columbia. Eligibility is limited by vehicle age, mileage and other factors. General Motors reserves the right to change eligibility limitations and/or discontinue its participation in this program.

Customer Assistance for Text Telephone (TTY) Users

To assist customers who are deaf, hard of hearing, or speech-impaired and who use Text Telephones (TTYs), Cadillac has TTY equipment available at its Customer Assistance Center. Any TTY user can communicate with Cadillac by dialing: 1-800-833-CMCC (2622). (TTY users in Canada can dial 1-800-263-3830.)

Customer Assistance Offices

Cadillac encourages customers to call the toll-free number for assistance. If a U.S. customer wishes to write to Cadillac, the letter should be addressed to Cadillac's Customer Assistance Center.

United States

Cadillac Customer Assistance Center
 Cadillac Motor Car Division
 P.O. Box 436004
 Pontiac, MI 48343-6004

1-800-458-8006
 1-800-833-2622 (For Text Telephone devices (TTYs))
 Roadside Assistance: 1-800-882-1112

Canada

General Motors of Canada Limited
 Customer Communication Centre, 163-005
 1908 Colonel Sam Drive
 Oshawa, Ontario L1H 8P7

1-800-263-3777 (English)
 1-800-263-7854 (French)
 1-800-263-3830 (For Text Telephone devices (TTYs))
 Roadside Assistance: 1-800-882-1112

All Overseas Locations

GMODC - Customer Communication Centre
 169-007
 1908 Colonel Sam Drive
 Oshawa, Ontario L1H 8P7

Telephone: 905-644-4112
 Fax: 905-644-4866

Caribbean Numbers

1-800-496-9992 (English) Puerto Rico
 1-800-496-9993 (Spanish) Puerto Rico
 1-800-751-4135 (English) Dominican Republic
 1-800-751-4136 (Spanish) Dominican Republic
 1-800-496-9994 U.S. Virgin Islands
 1-800-389-0009 Bahamas
 1-800-534-0122 Bermuda, Barbados, Antigua & B.V.I.

If toll free service is not available in the Caribbean, call Puerto Rico 1-787-763-1315.

GM Mobility Program for Persons with Disabilities

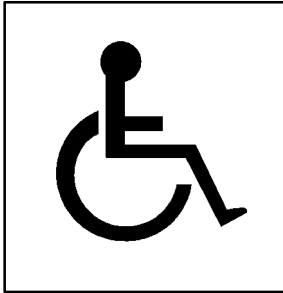

This program, available to qualified applicants, can reimburse you up to \$1,000 toward aftermarket driver or passenger adaptive equipment you may require for your vehicle (hand controls, wheelchair/scooter lifts, etc.).

This program can also provide you with free resource information, such as area driver assessment centers and mobility equipment installers. The program is available for a limited period of time from the date of vehicle purchase/lease. See your dealer for more details or call the GM Mobility Assistance Center at 1-800-323-9935. Text telephone (TTY) users, call 1-800-833-9935.

GM of Canada also has a Mobility Program. Call 1-800-GM-DRIVE (463-7483) for details. When calling from outside Canada, please dial 1-905-644-3063. TTY users call 1-800-263-3830.

Roadside Service



Cadillac's exceptional Roadside Service is more than an auto club or towing service. It provides every Catera owner with the advantage of contacting a Cadillac advisor and, when appropriate, a Catera trained dealer technician who can provide on-site service.

Each technician travels with a specially equipped service vehicle complete with the necessary Catera parts and tools required to handle most roadside repairs.

Cadillac Roadside Service® can be reached by dialing 1-800-882-1112, 24 hours a day, 365 days a year. This service is provided at no charge for any warranty-covered situation and for a nominal charge if the Catera is no longer under warranty. Roadside Service is available only in the United States and Canada.

Cadillac Owner Privileges™

Roadside Service provides several Cadillac Owner Privileges™ at “no charge,” throughout your *1999 Cadillac Warranty Period -- 48 months/50,000 miles (80 000 km)*.



Emergency Road Service is performed on site for the following situations:

- Towing Service
- Battery Jump Starting
- Lock Out Assistance
- Fuel Delivery
- Flat Tire Change (Covers change only)
- Trip Interruption -- If your trip is interrupted due to a warranty failure, incidental expenses may be reimbursed during the 48 months/50,000 miles (80 000 km) warranty period. Items covered are hotel, meals and rental car.

Roadside Service Availability

Wherever you drive in the United States or Canada, an advisor is available to assist you over the phone. A dealer technician, if available, can travel to your location within a 30 mile (50 km) radius of a participating Catera dealership. If beyond this radius, we will arrange to have your car towed to the nearest Catera dealership.

Reaching Roadside Service

Dial the toll-free Roadside Service number: 1-800-882-1112. An experienced Roadside Service Advisor will assist you and request the following information:

- A description of the problem
- Name, home address, home telephone number
- Location of your Catera and number you are calling from
- The model year, Vehicle Identification Number (VIN), mileage and date of delivery



Roadside Service for the Hearing or Speech Impaired

Roadside Service is prepared to assist owners who have hearing difficulties or are speech impaired. Cadillac has installed special telecommunication devices called Text Telephone (TTY) in the Roadside Service Center.

Any customer who has access to a (TTY) or a conventional teletypewriter can communicate with Cadillac by dialing from the United States or Canada 1-800-833-CMCC (2622) -- daily, 24 hours.

Courtesy Transportation

Cadillac has always exemplified quality and value in its offering of motor vehicles. To enhance your ownership experience, we and our participating dealers are proud to offer Courtesy Transportation, a customer support program for new vehicles.

The Courtesy Transportation program is offered to retail purchase/lease customers in conjunction with the Bumper to Bumper coverage provided by the New Vehicle Limited Warranty. Several transportation options are available when warranty repairs are required. This will reduce your inconvenience during warranty repairs.

Plan Ahead When Possible

When your vehicle requires warranty service, you should contact your dealer and request an appointment. By scheduling a service appointment and advising your service consultant of your transportation needs, your dealer can help minimize your inconvenience. If it is determined that your vehicle cannot be scheduled into the service department immediately and is still operative, you are encouraged to drive the vehicle until scheduling can be accomplished.

If the dealer requests that you simply drop the vehicle off for service, you are urged to do so as early in the work day as possible to allow for same day repair.

Transportation Options

Warranty service can generally be completed while you wait. However, if you are unable to wait Cadillac helps minimize your inconvenience by providing several transportation options. Depending on the circumstances, your dealer can offer you one of the following:

Shuttle Service

Participating dealers can provide you with shuttle service to get you to your destination with minimal interruption of your daily schedule. This includes a one way shuttle ride to a destination up to 10 miles from the dealership.

Public Transportation or Fuel Reimbursement

If your vehicle requires overnight warranty repairs, reimbursement up to \$30 per day (five days maximum) may be available for the use of public transportation such as taxi or bus. In addition, should you arrange transportation through a friend or relative, reimbursement for reasonable fuel expenses up to \$10 per day (five day maximum) may be available. Claim amounts should reflect actual costs and be supported by original receipts.

Courtesy Rental Vehicle

When your vehicle is unavailable due to warranty repairs, your dealer may arrange to provide you with a courtesy rental vehicle or reimburse you for a rental vehicle you obtained, at actual cost, up to a maximum of \$35.00 per day supported by receipts. This requires that you sign and complete a rental agreement and meet state, local and rental vehicle provider requirements. Requirements vary and may include minimum age requirements, insurance coverage, credit card, etc. You are responsible for fuel usage charges and may also be responsible for taxes, levies, usage fees, excessive mileage or rental usage beyond the completion of the repair.

Generally it is not possible to provide a like-vehicle as a courtesy rental.

Additional Program Information

Courtesy Transportation is available during the Bumper-to-Bumper warranty coverage period, but it *is not* part of the New Vehicle Limited Warranty. A separate booklet entitled “Warranty and Owner Assistance Information” furnished with each new vehicle provides detailed warranty coverage information.

Courtesy Transportation is available only at participating dealers and all program options, such as shuttle service, may not be available at every dealer. Please contact your dealer for specific information about availability. All Courtesy Transportation arrangements will be administered by appropriate dealer personnel.

Canadian Vehicles: For warranty repairs during the Complete Vehicle Coverage period of the General Motors of Canada New Vehicle Limited Warranty, alternative transportation may be available under the Courtesy Transportation Program. Please consult your dealer for details.

General Motors reserves the right to unilaterally modify, change or discontinue Courtesy Transportation at any time and to resolve all questions of claim eligibility pursuant to the terms and conditions described herein at its sole discretion.

General Motors and participating dealers reserve the right to deny a rental vehicle to anyone not possessing a valid motor vehicle operators license in their name, anyone who is under the influence of alcohol or drugs, or anyone whose mental or physical abilities are impaired so as to be unable to operate a motor vehicle safely.

Warranty Information

Your vehicle comes with a separate warranty booklet that contains detailed warranty information.

REPORTING SAFETY DEFECTS TO THE UNITED STATES GOVERNMENT

If you believe that your vehicle has a defect which could cause a crash or could cause injury or death, you should immediately inform the National Highway Traffic Safety Administration (NHTSA), in addition to notifying General Motors.

If NHTSA receives similar complaints, it may open an investigation, and if it finds that a safety defect exists in a group of vehicles, it may order a recall and remedy campaign. However, NHTSA cannot become involved in individual problems between you, your dealer or General Motors.

To contact NHTSA, you may either call the Auto Safety Hotline toll-free at 1-800-424-9393 (or 366-0123 in the Washington, D.C. area) or write to:

NHTSA, U.S. Department of Transportation
Washington, D.C. 20590

You can also obtain other information about motor vehicle safety from the hotline.

REPORTING SAFETY DEFECTS TO THE CANADIAN GOVERNMENT

If you live in Canada, and you believe that your vehicle has a safety defect, you should immediately notify Transport Canada, in addition to notifying General Motors of Canada Limited. You may write to:

Transport Canada
330 Sparks Street
Tower C
Ottawa, Ontario K1A 0N5

REPORTING SAFETY DEFECTS TO GENERAL MOTORS

In addition to notifying NHTSA (or Transport Canada) in a situation like this, we certainly hope you'll notify us. Please call us at 1-800-458-8006, or write:

Cadillac Customer Assistance Center
Cadillac Motor Car Division
P.O. Box 436004
Pontiac, MI 48343-6004

In Canada, please call us at 1-800-263-3777 (English) or 1-800-263-7854 (French). Or, write:

General Motors of Canada Limited
Customer Communication Centre, 163-005
1908 Colonel Sam Drive
Oshawa, Ontario L1H 8P7

Ordering Service and Owner Publications in Canada

Service manuals, owner's manuals and other service literature are available for purchase for all current and past model General Motors vehicles.

The toll-free telephone number for ordering information in Canada is 1-800-668-5539.

1999 CADILLAC SERVICE PUBLICATIONS ORDERING INFORMATION

The following publications covering the operation and servicing of your vehicle can be purchased by filling out the Service Publication Order Form in this book and mailing it in with your check, money order, or credit card information to Helm, Incorporated (address below.)

CURRENT PUBLICATIONS FOR 1999 CADILLAC

SERVICE MANUALS

Service Manuals have the diagnosis and repair information on engines, transmission, axle, suspension, brakes, electrical, steering, body, etc.

RETAIL SELL PRICE: \$90.00

TRANSMISSION, TRANSAXLE, TRANSFER CASE UNIT REPAIR MANUAL

This manual provides information on unit repair service procedures, adjustments and specifications for the 1999 GM transmissions, transaxles and transfer cases.

RETAIL SELL PRICE: \$50.00

SERVICE BULLETINS

Service Bulletins give technical service information needed to knowledgeably service General Motors cars and trucks.

Each bulletin contains instructions to assist in the diagnosis and service of your vehicle.

OWNER'S INFORMATION

Owner publications are written directly for Owners and intended to provide basic operational information about the vehicle.

Owner's Manual.

RETAIL SELL PRICE: \$15.00

CURRENT & PAST MODEL ORDER FORMS

Service Publications are available for current and past model GM vehicles. To request an order form, please specify year and model name of the vehicle.

PLEASE COMPLETE THE ORDER FORM SHOWN ON THE FOLLOWING PAGE AND MAIL TO:

Helm, Incorporated • P.O. Box 07130 • Detroit, MI 48207

OR ORDER TOLL FREE: 1-800-551-4123

Monday-Friday 8:00 AM – 6:00 PM Eastern Time

For Credit Card Orders Only (VISA–MasterCard–Discover)



Section 8 Index

A dding Equipment to the Outside of Your Vehicle	6-3	Appearance Care	6-46
Add-On Electrical Equipment	6-55	Appearance Care Chart	6-53
Aiming, Headlamps	6-33	Arbitration Program (Step Three)	7-3
Air Bag	1-24	Ashtrays and Cigarette Lighter	2-50
How Does it Restrain	1-30	Assist Handles	2-52
How the Systems Work	1-27	Audio Sound Equipment, Adding	3-29
Location	1-27	Audio Steering Wheel Controls	3-27
Readiness Light	1-27, 2-64	Audio Systems	3-9
Servicing	1-32	Automatic Door Locks	2-5
What Makes it Inflate	1-30	Automatic Operation (Climate Controls)	3-3
What Will You See After it Inflates	1-30	Automatic Transmission	
When Should it Inflate	1-29	Fluid	6-18
Air Cleaner/Filter, Engine	6-15	Operation	2-21
Air Conditioning	3-6	Shifting	2-21
Air Conditioning Refrigerants	6-63	Starting Your Engine	2-18
Alarm, Theft-Deterrent	2-13	Warning Light	2-76
Alignment and Balance, Tire	6-44	Axle, Rear	6-19
Aluminum Wheels, Cleaning	6-51	B attery	6-29
Antenna, Heated Backlite	3-31	Jump Starting	5-2
Antifreeze	6-20	Replacement, Remote Keyless Entry	2-9
Anti-Lock		Warnings	5-3, 5-4, 5-5
Brake System Warning Light	2-67, 4-7	Better Business Bureau (BBB) Mediation (Step Three)	7-3
Brakes (ABS)	4-7	Blade Replacement, Windshield Wipers	6-36
Anti-Lockout Feature	2-7	Blizzard	4-27
Anti-Pinch Feature	2-33, 2-54		

Brake		Cellular Telephone	2-52
Adjustment	6-28	Center Console Storage Area	2-50
Fluid	6-26	Center High-Mounted Stoplamp (CHMSL), Bulb Replacement	6-34
Master Cylinder	6-26	Central Door Unlocking System	2-4
Pad Wear Indicator Light	2-76	Certification Label	4-29
Parking	2-25	Chains, Safety	4-34
Pedal Travel	6-28	Chains, Tire	6-45
Replacing System Parts	6-29	Changing a Flat Tire	5-18
System Warning Light	2-66	Charging System Indicator Light	2-65
To Shift Light	2-73	Check Engine Light	2-70
Transmission Shift Interlock (BTSI)	2-28	Check Oil Light	2-73
Wear	6-27	Checking Things Under the Hood	6-8
Brakes	6-26	Checking Your Restraint Systems	1-52
Anti-Lock	4-7	Chemical Paint Spotting	6-52
Trailer	4-34	Child Restraints	1-39
Braking	4-6	Securing in a Rear Seat Position	1-44
Braking in Emergencies	4-10	Securing in the Right Front Seat Position	1-46
Break-In, New Vehicle	2-16	Top Strap	1-44
Brightness Control	2-46	Where to Put	1-43
Bulb Replacement	6-30	Children (Safety Belts)	1-36
C apacities and Specifications	6-62	Chrome-Plated Wheels, Cleaning	6-51
Carbon Monoxide	2-11, 2-30, 2-31, 4-28	Cigarette Lighter	2-50
Care of Your Cassette Tape Player	3-29	Cleaner, Air	6-15
Care of Your Compact Disc Player	3-31	Cleaning	
Care of Your Compact Discs	3-30	Aluminum or Chrome-Plated Wheels	6-51
Carpet Cleaning	6-46	Exterior Lamps/Lenses	6-50
Cassette Tape Player Errors	3-11, 3-19	Fabric/Carpet	6-46
CD Adapter Kits	3-23	Glass Surfaces	6-48
CD Changer	3-23	Inside of Your Vehicle	6-46
		Interior Plastic Components	6-48

Leather	6-47	Customer Assistance	
Outside of the Windshield and Wiper Blades	6-48	Information	7-1
Outside of Your Vehicle	6-49	Offices	7-4
Speaker Covers	6-48	Text Telephone (TTY) Users	7-3
Tires	6-51	Customer Satisfaction Procedure	7-2
Top of the Instrument Panel	6-47	D amage, Finish	6-52
Vinyl	6-47	Damage, Sheet Metal	6-51
Wheels	6-51	Daytime Running Lamps (DRL)	2-42
Climate Control System	3-2	Dead Battery	5-2
Clock, Setting the	3-9	Defects, Reporting Safety	7-10, 7-11
Cluster, Instrument Panel	2-62	Defensive Driving	4-2
Comfort Controls	3-2	Defogger, Rear Window	3-7
Comfort Controls and Audio Systems	3-1	Defrosting	3-6
Compact Disc Changer Errors	3-26	Dimensions, Vehicle	6-63
Compartments, Storage	2-49	Dolby Noise Reduction	3-13, 3-20
Console Shift Lever	2-27	Door	
Console Storage	2-50	Central Unlocking System	2-4
Control of a Vehicle	4-6	Locks	2-4
Convenience Net	2-50	DRIVE (D), Automatic Transmission	2-23
Convex Outside Mirror	2-49	Driver Position	1-16
Coolant	6-20	Driver's Side Instrument Panel Fuse Block	6-57
Adding	6-23	Driver's Side Temperature Knob	3-2
Checking	6-22	Driving	
Heater, Engine	2-19	City	4-19
How to Add to the Coolant Surge Tank	5-13	Defensive	4-2
Surge Tank	5-11	Drunken	4-3
What to Use	6-21	Freeway	4-20
Cooling System	5-11	In a Blizzard	4-27
Cornering Lamps	2-44	In Foreign Countries	6-5
Courtesy Transportation	7-8	In Rain and on Wet Roads	4-17
Cruise Control	2-37		
Cruise Control Light	2-74		

Driving (Continued)		Engine Oil	6-11
Night	4-15	Additives	6-14
On Curves	4-10	Checking	6-11
On Grades While Towing a Trailer	4-36	What Kind to Use	6-12
On Hill and Mountain Roads	4-23	What to do with Used	6-14
On Snow or Ice	4-25	When to Add	6-12
Through Deep Standing Water	4-19	When to Change	6-14
Winter	4-24	English/Metric Display	3-3
With a Trailer	4-34	Ethanol	6-4
E lectrical Equipment, Adding	2-19	Exhaust, Engine	2-11, 2-30, 2-31, 4-28
Electrical System	6-55	Extender, Safety Belts	1-52
Electrochromic Day/Night Rearview Mirror	2-47	Exterior Lamps	2-40
Electronic Climate Control (ECC)	3-2	F an Button, Climate Control System	3-2
Electronic Level Control	4-30	Features and Controls	2-1
Emergency Trunk Release	2-12	Filling a Portable Fuel Container	6-8
Engine	6-10	Filling Your Tank	6-5
Air Cleaner/Filter	6-15	Filter, Air	6-15
Compartment Relay Center	6-61	Filter Replacement, Passenger Compartment Air	6-17
Coolant	6-20	Finish Care	6-50
Coolant Heater	2-19	Finish Damage	6-52
Coolant Temperature Gage	2-69	FIRST (1) Gear, Automatic Transmission	2-23
Coolant Temperature Warning Light	2-68	Flashers, Hazard Warning	5-2
Cooling When Trailer Towing	4-37	Flash-To-Pass	2-35
Exhaust	2-11, 2-30, 2-31, 4-28	Flat Tire, Changing	5-18
Identification	6-54	Floor Mats	2-52
Overheating	5-9	Fluid	
Running While You're Parked	2-31	Brake	6-26
Specifications	6-63	Power Steering	6-24
Speed Limiter	2-63	Windshield Washer	6-25
Starting Your	2-18	Fog Lamps	2-44

Folding the Rear Seat	1-8	Head Restraints	1-6
Foreign Countries, Fuel	6-5	Headlamps	2-41, 6-30
French Language Manual	ii	Aiming	6-33
Front Turn Signal Lamp, Bulb Replacement	6-33	Bulb Replacement	6-30
Fuel	6-3	High/Low Beam	2-35
Cap Indicator Light	2-75	On Reminder	2-42
Door Lock	6-6	Wiper-Activated	2-42
Filling a Portable Container	6-8	Wiring	6-55
Filling Your Tank	6-5	Hearing Impaired, Customer Assistance	7-3
Gage	2-74	Heated Backlite Antenna	3-31
In Foreign Countries	6-5	Heated Rearview Mirrors	2-49
Fuse Block, Instrument Panel	6-57	Heated Seats	1-4, 1-10
Fuse Block, Power Distribution	6-56	Heating	3-6
Fuses and Circuit Breakers	6-56	High-Beam Headlamps	2-35
		Highway Hypnosis	4-22
		Hill and Mountain Roads	4-23
		Hitches	4-33
G ages		Hood	
Engine Coolant Temperature	2-69	Checking Things Under	6-8
Fuel	2-74	Release	6-9
Oil Pressure	2-72	Horn	2-33
Garment Hooks	2-52	How to Add Coolant to the Coolant Surge Tank	5-13
Gear Positions, Automatic Transmission	2-21	How to Use this Manual	v
Glove Box	2-49	Hydraulic Brake Warning Lights	2-66
GM Mobility Program for Persons with Disabilities	7-5	Hydroplaning	4-18
GM Vehicle Care/Appearance Materials	6-53		
Gross Axle Weight Rating (GAWR)	4-30	I f You're Stuck: In Sand, Mud, Ice or Snow	5-28
Gross Vehicle Weight Rating (GVWR)	4-30	Ignition Positions	2-16
Guide en Français	ii	Illuminated Entry	2-46
		Illuminated Visor Vanity Mirror	2-51
		Immobilizer	2-15
H alogen Bulbs	6-30		
Handles, Assist	2-52		
Hazard Warning Flashers	5-2		

Inflation, Tire Pressure	6-38	Leveling Indicator Light	2-76
Instrument Panel	2-60	Light Sensor, Twilight Sentinel [®]	2-44
Brightness Control	2-46	Lighter	2-50
Cleaning the Top	6-47	Lighting, Perimeter	2-42
Cluster	2-62	Lights	
Fuse Block	6-57	Air Bag Readiness	1-27, 2-64
Interior Lamps	2-46	Anti-Lock Brake System Warning	2-67, 4-7
Interior Plastic Components, Cleaning	6-48	Automatic Transmission Warning	2-76
		Brake Pad Wear Indicator	2-76
		Brake System Warning	2-66
		Brake To Shift	2-73
		Charging System Indicator	2-65
		Check Engine	2-70
		Check Oil	2-73
		Cruise Control	2-74
		Engine Coolant Temperature Warning	2-68
		Fuel Cap Indicator	2-75
		Leveling Indicator	2-76
		Low Coolant Warning	2-69
		Low Fuel	2-75
		Low Washer Fluid Warning	2-74
		Oil Pressure	2-72
		Safety Belt Reminder	1-11, 2-64
		Traction Control System Warning	2-68, 4-9
		Trunk Ajar	2-74
		Loading Your Vehicle	4-29
		Locks	
		Anti-Lockout Feature	2-7
		Automatic Door	2-5
		Door	2-4
		Fuel Door	6-6
J ack, Tire	5-20, 5-21		
Jump Starting	5-2		
K eyless Entry System, Remote	2-7		
Keys	2-2		
L abels			
Certification	4-29		
Service Parts Identification	6-54		
Tire-Loading Information	4-29		
Vehicle Identification Number (VIN)	6-54		
Lamps			
Exterior	2-40		
Interior	2-46		
Map	2-47		
On Reminder	2-42		
Panel	2-46		
Rear Reading	2-46		
Lap-Shoulder Belt	1-16, 1-33		
Leaving Your Vehicle	2-7		
Leaving Your Vehicle with the Engine Running	2-27		

Power Door	2-5	Model Reference	ii
Programmable Automatic Door	2-5	Mountain Roads	4-23
Rear Door Security	2-6	Multifunction Lever	2-34
Loss of Control	4-14	N et, Convenience	2-50
Low Coolant Warning Light	2-69	NEUTRAL (N), Automatic Transmission	2-22
Low Fuel Light	2-75	New Vehicle “Break-In”	2-16
Low Washer Fluid Warning Light	2-74	Night Vision	4-16
Lumbar Support, Manual	1-2	Normal Maintenance Replacement Parts	6-63
M aintenance, Normal Replacement Parts	6-63	O dometer	2-63
Maintenance, Underbody	6-52	Odometer, Trip	2-63
Maintenance When Trailer Towing	4-37	Off-Road Recovery	4-12
Malfunction Indicator Lamp	2-70	Oil, Engine	6-11
Manual Folding Outside Rearview Mirrors	2-49	Oil Pressure Light/Gage	2-72
Manual Lumbar Support	1-2	OnStar [®] System	2-52
Manual Operation (Climate Controls)	3-4	Ordering Service and Owner Publications	7-11, 7-12, 7-13
Map Lamps	2-47	Outside Rearview Mirrors, Manual Folding	2-49
Map Pockets	2-49	Outside Temperature Display	3-3
Memory Seat and Mirrors	1-3	Overheating Engine	5-9
Methanol	6-4	Owner Publications, Ordering	7-11, 7-12, 7-13
Mirrors	2-47	P aint Spotting, Chemical	6-52
Convex Outside	2-49	Panel, Instrument	2-60
Electrochromic Day/Night Rearview	2-47	P ARK (P)	
Heated Rearview	2-49	Automatic Transmission	2-21
Illuminated Visor Vanity	2-51	Shifting Into	2-26
Manual Folding Outside Rearview	2-49	Shifting Out of	2-28
Power Remote Control	2-48		
MMT	6-4		
Mobility Program for Persons with Disabilities	7-5		
Mode Button	3-3		

Parking			
At Night	2-12		
Brake	2-25		
Lots	2-13		
On Hills With a Trailer	4-37		
Over Things That Burn	2-30		
Passenger Compartment Air Filter	3-8		
Passenger Compartment Air Filter Replacement	6-17		
Passenger's Side Temperature Knob	3-2		
Passing	4-13		
Perimeter Lighting	2-42		
Playing a Cassette Tape	3-11, 3-19		
Playing a Compact Disc	3-21		
Power			
Distribution Fuse Block	6-56		
Door Locks	2-5		
Reclining Seatback	1-4		
Remote Control Mirror	2-48		
Retained Accessory	2-17		
Seats	1-2		
Steering	4-10		
Steering Fluid	6-24		
Windows	2-32		
Windows and Other Power Options	6-55		
Pregnancy, Use of Safety Belts	1-23		
Pretensioners, Safety Belt	1-32		
Problems on the Road	5-1		
Programmable Automatic Door Locks	2-5		
Programming the Power Windows	2-32		
Programming the Sunroof	2-55		
Programming the Universal Transmitter	2-57		
Publications, Service and Owner	7-11, 7-12		
		R adio Data Systems (RDS) Program Type (PTY)	
		Selections	3-22
		Radio Reception, Understanding	3-28
		Radios	3-9, 3-13
		Rain, Driving In	4-17
		Rear	
		Axle	6-19
		Door Security Locks	2-6
		Reading Lamps	2-46
		Seat Passenger Positions	1-33
		Seat Passengers	1-32
		Seats	1-7
		Sunshade	2-51
		Turn Signal Lamp, Bulb Replacement	6-35
		Window Defogger	3-7
		Window Lockout	2-33
		Rearview Mirror, Electrochromic Day/Night	2-47
		Recirculation	3-5
		Reclining Front Seatbacks	1-4
		Recreational Vehicle Towing	4-28
		Refrigerants, Air Conditioning	6-63
		Relay Box	6-60
		Relay Center, Engine Compartment	6-61
		Remote Fuel Door Release	6-6
		Remote Keyless Entry (RKE) System	2-7
		Removable Head Restraints	1-6
		Replacement	
		Bulbs	6-62
		Normal Maintenance Parts	6-63
		Wheel	6-44
		Replacing Brake System Parts	6-29
		Replacing Safety Belts	1-53

Reporting Safety Defects	7-10, 7-11	Use During Pregnancy	1-23
Restraints		Why They Work	1-12
Checking	1-52	Safety Chains	4-34
Child	1-39	Safety Defects, Reporting	7-10, 7-11
Head	1-6	Safety Warnings and Symbols	v
Replacing System Parts After a Crash	1-53	Seatback, Reclining Front	1-4
Retained Accessory Power (RAP)	2-17	Seats	
REVERSE (R), Automatic Transmission	2-22	Heated	1-4, 1-10
Right Front Passenger Position	1-24	Manual Lumbar Support	1-2
Roadside Service	7-5	Memory Seat and Mirrors	1-3
Rocking Your Vehicle	5-29	Power	1-2
Rotation, Tires	6-39	Rear	1-7
S afety Belts	1-10	Restraint Systems	1-1
Adults	1-16	Seat Controls	1-2
Care of	6-48	Securing a Child Restraint	1-44, 1-46
Children	1-36	SECOND (2) Gear, Automatic Transmission	2-23
Driver Position	1-16	Service	6-2
Extender	1-52	Appearance Care	6-1
How to Wear Properly	1-16	Bulletins, Ordering	7-11, 7-12, 7-13
Incorrect Usage	1-50, 1-51	Doing Your Own Work	6-2
Lap-Shoulder	1-16, 1-33	Manuals, Ordering	7-11, 7-12, 7-13
Larger Children	1-49	Owner Publications	7-11, 7-12, 7-13
Pretensioners	1-32	Parts Identification Label	6-54
Questions and Answers	1-15	Servicing Your Air Bag-Equipped Vehicle	1-32
Rear Seat Passenger Positions	1-33	Setting the Time	3-9
Rear Seat Passengers	1-32	Sheet Metal Damage	6-51
Reminder Light	1-11, 2-64	Shift Lever	2-21
Replacing Restraint System Parts After a Crash	1-53	Shift Lever, Console	2-27
Right Front Passenger Position	1-24	Shifting	
Shoulder Belt Height Adjuster	1-18	Automatic Transmission	2-21
		Into PARK (P)	2-26
		Out of PARK (P)	2-28

Shoulder Belt Height Adjuster	1-18
Signaling Turns	2-34
Skidding	4-14
Sound Equipment, Adding (Audio)	3-29
Speaker Covers, Cleaning	6-48
Specifications and Capacities	6-62
Specifications, Engine	6-63
Speech Impaired, Customer Assistance	7-3
Speed Limiter, Engine	2-63
Speedometer	2-63
Sport Mode Button	2-24
Starting Your Engine	2-18
Steam	5-9, 5-10
Steering	4-10
In Emergencies	4-11
Power	4-10
Speed Sensitive (SSS)	4-10
Tips	4-10
Wheel Controls for Audio System	3-27
Wheel, Tilt	2-34
Storage Compartments	2-49
Stuck: In Sand, Mud, Ice or Snow	5-28
Sun Visors	2-51
Sunroof	2-52
Anti-Pinch Feature	2-54
Manual Operation	2-54
Programming	2-55
Sunshade, Rear	2-51
Surge Tank, Coolant	5-11
Surge Tank Pressure Cap	6-20
Symbols, Vehicle	vii

T achometer	2-63
Taillamp and Rear Turn Signal Lamp	6-35
Tape Player Care	3-29
Telephone, Cellular	2-52
Temperature Display, Outside	3-3
Temperature Knobs, Climate Control System	3-2
Theft	2-12
Theft-Deterrent Feature (Radio)	3-27
Theft-Deterrent System	2-13
Theftlock [®]	3-27
Thermostat	6-20
THIRD (3) Gear, Automatic Transmission	2-23
Third-Gear Start	2-24
Tilt Wheel	2-34
Time, Setting the	3-9
Tips About Your Audio System	3-28
Tires	6-37
Alignment and Balance	6-44
Buying New	6-41
Chains	6-45
Changing a Flat	5-18
Cleaning	6-51
Inflation Pressure	6-38
Inspection and Rotation	6-39
Loading Information Label	4-29
Temperature	6-43
Traction	6-43
Treadwear	6-43
Uniform Quality Grading	6-42
Wear Indicators	6-41
Wheel Replacement	6-44
When It's Time for New	6-41

Top Strap	1-44	Transportation, Courtesy	7-8
Torque Lock	2-28	Trip Odometer	2-63
Torque, Wheel Bolt	5-26, 6-63	Trunk	2-11
Towing a Trailer	4-31	Ajar Light	2-74
Towing, Recreational Vehicle	4-28	Mounted CD Changer	3-23
Towing Your Vehicle	5-8	Release	2-11
Traction		TTY Users	7-3
Control System	4-9	Turn and Lane Change Signals	2-34
Control System Warning Light	2-68, 4-9	Turn Signal/Multifunction Lever	2-34
Trailer		Turn Signals When Towing a Trailer	4-35
Backing Up	4-35	Twilight Sentinel®	2-44
Brakes	4-34	U nderbody Maintenance	6-52
Driving on Grades	4-36	Understanding Radio Reception	3-28
Driving with	4-34	Universal Transmitter	2-56
Engine Cooling When Towing	4-37	Accessories	2-59
Following Distance	4-34	Erasing Channels	2-59
Hitches	4-33	Operating	2-58
Maintenance When Towing	4-37	Programming	2-57
Making Turns	4-35	Training a Garage Door Opener with “Rolling Codes”	2-58
Parking on Hills	4-37	V ehicle	
Passing	4-35	Control	4-6
Safety Chains	4-34	Damage Warnings	vi
Tongue Weight	4-32	Dimensions	6-63
Total Weight on Your Vehicle’s Tires	4-33	Identification Number (VIN)	6-54
Towing	4-31	Symbols	vii
Turn Signals When Towing	4-35	Ventilation System	3-7
Weight	4-32	Visor Vanity Mirror, Illuminated	2-51
Training a Garage Door Opener with “Rolling Codes”	2-58	Visors, Sun	2-51
Transmission Fluid , Automatic	6-18	Voltmeter	2-65
Transmitter, Remote Keyless Entry (RKE) System	2-7		
Transmitter, Universal	2-56		

W arning Devices, Other	5-2	Power	2-32
Warning Lights, Gages and Indicators	2-63	Programming the Power Windows	2-32
Warranty Information	7-10	Rear Lockout	2-33
Washing Your Vehicle	6-49	Windshield	
Weatherstrips	6-49	Washer	2-36
Weight of the Trailer	4-32	Washer Fluid	2-36, 6-25
Weight of the Trailer Tongue	4-32	Wiper Blades, Cleaning	6-48
Wheel		Wiper Fuses	6-55
Alignment and Tire Balance	6-44	Wipers	2-35
Bolt Torque	5-26, 6-63	Wipers, Blade Replacement	6-36
Replacement	6-44	Winter Driving	4-24
Wrench	5-21	Wiper-Activated Headlamps	2-42
Where to Put Child Restraints	1-43	Wiring, Headlamp	6-55
Windows	2-32	Wrench, Wheel	5-21
Anti-Pinch Feature	2-33		