

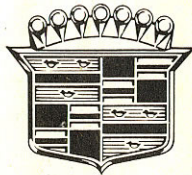

Nineteen Sixty-Five

CADILLAC

Owner's Manual



Your luxurious new 1965 Cadillac will provide you with many miles of motoring pleasure in the months to come. The information in this manual will help you derive the utmost satisfaction and performance from your new Cadillac.

We suggest you review the operating instructions carefully so that you can enjoy the many exclusive features engineered into the motor car. A complete understanding of the proper operating procedure will add further to your enjoyment of your 1965 Cadillac.

The operating instructions that pertain exclusively to the Fleetwood Seventy-Five Sedan and Limousine are explained in Section 3, beginning on page 28. The general information and service recommendations found in other sections of this manual apply to all 1965 model Cadillac cars.

This information was prepared to assist you. Follow the instructions carefully, and if a question should ever occur that is not answered here, do not hesitate to write us. We will be happy to hear from you at any time.

SERVICE DEPARTMENT
CADILLAC MOTOR CAR DIVISION
GENERAL MOTORS CORPORATION
DETROIT, MICHIGAN 48232



OPERATING YOUR CADILLAC

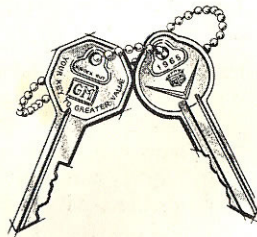

Your new Cadillac is ready for all normal driving just as you receive it from your dealer. Precision manufacturing techniques have prepared it for the road and a formal break-in period is not required. From the very start, drive your new Cadillac in a normal manner at varying speeds, as required by different traffic and road situations.

SECTION

1

Keys

Two separate keys are provided for your convenience. The key with the octagonal head operates the ignition and door locks. The rounded key is used in the luggage compartment and glove box door locks, and in the center console on models with bucket seats, to protect the contents of these compartments when it is necessary to leave the ignition key with your car. Remove the "knock-out" plug with key number from the key head and keep it, or a record of the number, to facilitate replacement or duplication of your keys.

Ignition switch

The ignition switch is located in the center of the instrument panel to the left of the radio. The key slot is illuminated when instrument panel lights are on. The key can be turned to any one of three positions, but can be inserted or withdrawn only in the straight-up, "OFF" position. First position "right" completes the ignition circuit and activates all instruments and accessories. Full "right" position cranks the engine. The "left" position is for operation of accessories with ignition off. For your own protection and to cooperate with civil authorities, remove the key and lock the car when leaving it unattended.

Instructions for starting the engine

The starter operates when the ignition key is turned to the full "right" position, *provided* the transmission selector lever is in either "Neutral" or "Park". For safety, the starter is inoperative in all driving positions. When the engine is cold, press the accelerator pedal slowly to the toeboard once, then remove your foot, and turn the key to the full "right" position. **DO NOT** hold the key in full "right" position longer than 15 seconds at one time. If the car has been standing over 48 hours, it is helpful to pump the accelerator three times before starting.

Normal restarting

If the engine is warm from previous running (within the last two to four hours), hold the accelerator part way down while cranking.

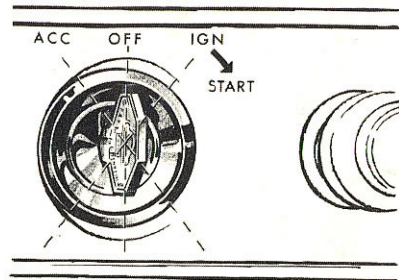

Extreme cold weather starting

The starting procedure for extreme cold weather is basically the same as for normal conditions. Should the engine start, run a few seconds and then stall, repeat the normal starting procedure. If the engine does not restart within five seconds of cranking, push the accelerator to the floor and hold it (**DO NOT PUMP**) while continuing to crank until engine starts. Do not crank engine longer than 15 seconds at a time. Proper engine oil viscosity is very important for easy cold weather starting. See page 40.

Flooded engine

Hold accelerator pedal all the way down and crank until engine starts (not over 15 seconds at a time).

INSTRUMENTS

NOTE: Fuel and temperature gauge needles do not necessarily return to the left when ignition is turned "OFF", but may stop at any point on the gauge.

Fuel gauge

The fuel gauge is located on the lower right side of the instrument cluster. It registers only when the ignition key is turned to the right.

Temperature indicator

The engine temperature gauge is located on the lower left side of the instrument cluster. Normally, the gauge pointer will move gradually from the extreme left to a center position.

Do not be alarmed if the pointer registers above the center range in heavy traffic or on long drives during warm weather. The pressure-controlled overflow will normally prevent coolant losses up to 259°F. If the pointer reaches "H" or if the coolant boils, indicated by a buzzing sound from the radiator cap, stop the car immediately and have the condition causing the overheating corrected. CAUTION: Before removing radiator cap, see page 41.

Oil pressure indicator light

If oil pressure is low, a red indicator light labeled "OIL", located on the right side of the instrument cluster will glow. Under normal conditions this light will glow when

the ignition is turned on, but will go off when the engine is running. If it does not go off, the car should not be operated until the cause of the low oil pressure has been corrected by an Authorized Cadillac Dealer.

Generator indicator light

A red indicator light for the charging circuit is located on the left side of the instrument cluster above the temperature gauge. The light, labeled "GEN", glows whenever the generator is *not* charging. In normal operation, it will light when the ignition is turned on and will go out when the engine starts. If it glows while the engine is running, have your car checked by an Authorized Cadillac Dealer.

Speedometer

The speedometer indicates car speed. The odometer portion which indicates distance traveled, is divided into two

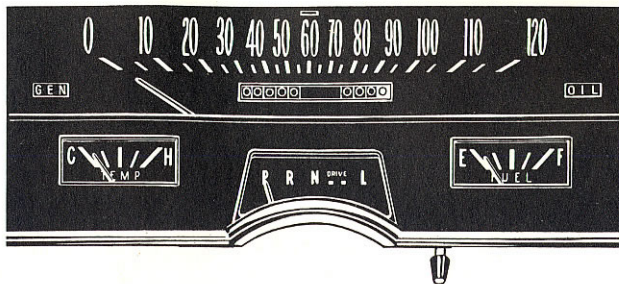

sections—the left half records accumulated mileage and the right half indicates trip mileage. A reset knob for the trip odometer is located below the instrument cluster to the right of the steering column. To reset trip mileage, push in on the reset knob and turn it clockwise until all nines appear. Repeat this operation until all nines reappear, then reverse the knob until all zeros appear.

TRANSMISSION

Your 1965 Cadillac is equipped with a Turbo Hydramatic transmission. The transmission shift indicator has six positions marked park "P", reverse "R", neutral "N", drive "DRIVE" (left and right positions), and low "L".

An arrangement of steps in the steering column restricts a straight line movement of the shift lever. It is necessary to lift up on the lever when shifting into and out of park "P", when shifting from the left hand "DRIVE" position to the right hand "DRIVE" position, and when shifting from "DRIVE" to low "L".

"DRIVE" range

In drive range with the indicator in the left hand "DRIVE" position, three forward speeds are available; the right hand "DRIVE" position provides two forward speeds. The left hand "DRIVE" position is used for all normal driving. This permits the transmission to operate through its complete range of gear ratios and select the proper

gear ratio for road and load conditions.

HILLY TERRAIN—use the right-hand "DRIVE" position. In this position, only first and second speeds are available, improving acceleration and deceleration. The right-hand "DRIVE" position also reduces shifting in traffic and on hills, provides more control on slippery pavement, and decreases brake usage when descending medium grades. It may be selected at any car speed.

PROLONGED IDLING IN HEAVY TRAFFIC—place shift lever in neutral "N" when engine must be idled for long periods in heavy traffic during hot weather.

PASSING—for passing at moderate speeds—between 30-45 miles per hour—depressing the accelerator pedal only part way will usually provide sufficient acceleration. This automatically downshifts the transmission to a lower gear for more power. When additional acceleration is needed for safety in passing at higher speeds, press the accelerator all the way down.

"L" Low range

"L" Low range provides engine braking assist. It should always be used when going up or down very steep grades and where traffic signs call for first or second gear.

A shift from either "DRIVE" position to low "L" can be made while traveling at moderate speeds. This shift is not recommended when the pavement is slippery or when in loose gravel, as it may induce a skid.

NOTE: Should the wheels slide when braking on ice, the transmission may shift to a lower gear. If this occurs, move the shift lever to neutral "N" until control is recovered. Use of intermittent brake pressure when on ice will result in better car control.

"R" reverse

To back up your car, first bring it to a *complete* stop, then move shift lever to the reverse "R" position. The shift lever can be moved to reverse "R" from neutral "N" or any "DRIVE" position without lifting up on the lever. However, it is necessary to lift up on the lever when shifting to reverse "R" from park "P" position.

"P" park

Place shift lever in the park "P" position to lock rear wheels when parked. When parking on hills or steep inclines, apply parking brake and turn front wheels toward curb. It is necessary to raise the shift lever when moving it from any other position to park "P" and also when moving it from the park "P" position. NEVER move the lever to park "P" with the car in motion.

Emergency starting procedure

The engine cannot be started by pushing the car. If the trouble appears to be a discharged battery, a booster battery and jumper cables should be used. If this fails to

start the engine, the car should be towed to an Authorized Cadillac Dealer.

Towing

If the transmission, drive line, and rear axle are in proper operating condition, the 1965 Cadillac can be safely towed at speeds up to 45 MPH for distances up to 50 miles. Always tow car with transmission shift lever in "Neutral" position.

For higher speeds or longer distances, the propeller shaft must be disconnected or the rear wheels raised off the ground. If towing requires raising the rear of the car, the wheels should be raised just slightly off the ground and the steering wheel should be tied down with front wheels in straight ahead position.

CONTROLLED DIFFERENTIAL

A Controlled Differential (optional at extra cost) is available on all models. The Controlled Differential makes driving safer and more economical by providing additional traction in snow, ice, mud, sand and gravel, particularly when one rear wheel is on a surface providing poor traction.

During normal driving and cornering, the controlled unit functions as a standard differential. When one wheel encounters a slippery surface, however, the Controlled

Differential allows the wheel with the greater traction to drive the car.

CAUTION: On cars equipped with a Controlled Differential, do not jack one rear wheel off the ground with engine running.

POWER BRAKES

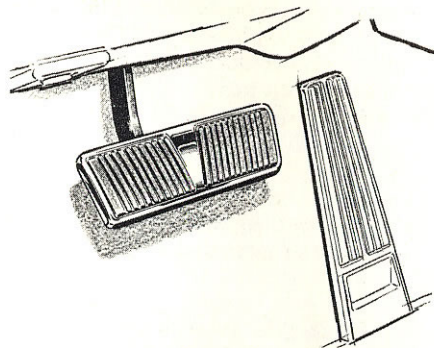

Your 1965 Cadillac is equipped with power brakes incorporating a dual reservoir master cylinder. With this type cylinder, the front and rear brakes have separate hydraulic systems. The rear brakes are not affected in the event of fluid leaks from the front hydraulic system. Likewise, the front brakes are not affected by loss of fluid from the rear hydraulic system. Loss of fluid is signaled by excessive brake pedal travel. If this condition is en-

countered, immediate inspection should be made by your Authorized Cadillac Dealer.

The power brake unit has a self-contained reserve tank that permits several applications of the brakes with power assist after the engine has stopped. After this reserve is used up, or should the power system become inoperative, the brakes can be applied in the conventional manner; however, more effort is required due to the loss of power assist. The width of the brake pedal will allow comfortable use of two-foot application. In the event of power assist being lost, the use of both feet on the pedal will result in a normal braking feel.

Under normal driving conditions your Cadillac does not require manual brake adjustments to compensate for lining wear. All wheels are equipped with automatic brake adjusters. The brakes are automatically adjusted, if adjustment is required, each time they are applied when the car is moving rearward. To assure best operation of the brake system, have brakes inspected periodically by your Authorized Cadillac Dealer.

Parking brake

To apply the parking brake, step on the parking brake pedal suspended from the underside of the instrument panel to the left of the power brake pedal. It will lock

into place automatically when the transmission is in "Park" or "Neutral" with engine running, or in any position with engine not running.

The parking brake will release automatically when the transmission selector lever is moved to any drive range with the engine running. A definite noise should be heard when the pedal releases. Do not drive the car unless the parking brake is completely released. Should it be necessary to release the brake manually, pull on the hand release lever located on the upper right side of the parking brake assembly. Since the parking brake will not lock into place when the transmission selector is in "Drive",

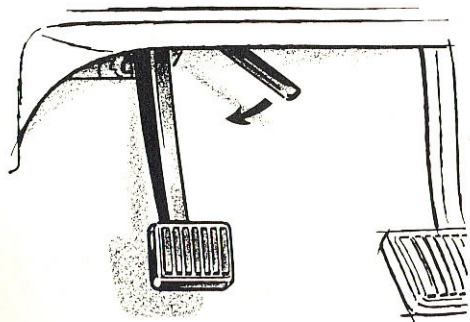

"Low" or "Reverse" ranges with the engine running, it may be used as a fully controllable brake pedal, providing rear wheel braking only, under emergency or special conditions.

As a safety precaution when parking on hills, it is advisable to turn the wheels toward the curb, lock the rear wheels by placing the transmission selector in "Park" position, and place the parking brake in its fully depressed position. When pedal travel of the parking brake exceeds five inches, it should be adjusted by your Authorized Cadillac Dealer.

POWER STEERING

Steering, turning, and parking are made almost effortless with Cadillac power steering. Your car provides easy and responsive steering, with power assist available as required by road conditions.

Your Cadillac may be steered manually with no power assist when the engine is not running. If your power steering becomes inoperative for any reason, the car may be steered manually, but with increased effort.

CONTROLS

Your new Cadillac has accessible controls and easy to read dials and instruments that are designed for your safety and convenience. Only a few minutes are required to gain an understanding of the proper use of these in-

struments and controls. Refer to the illustration on page 10 (or page 30) to become acquainted with your 1965 Cadillac instrument panel.

Windshield wipers and washers

The three-speed windshield wipers are controlled by a lever located on the instrument panel to the left of the steering column. To operate the wipers, move the lever to the first triangular mark "LOW", the second triangular mark "MEDIUM", or "HIGH" position. Do not try to move the blades by hand or attempt to run the wipers if the blades are frozen to the glass. Avoid operating the wipers on a dry windshield.

Windshield washers are provided for cleaning a windshield soiled with dust, road spray or dirt. Pressing the washer button, located to the left of the wiper control lever, actuates the wipers to operate at low speed and sprays solution on the windshield. When washing action is completed and the windshield is dry, move the wiper lever to the "OFF" position.

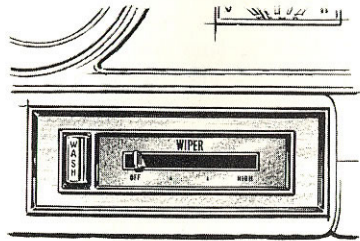

Headlight control

The control knob for the headlights, parking lights, instrument panel lights, and courtesy lights is located in the instrument cluster to the left of the speedometer. HEADLIGHTS are operated by pulling the switch control knob all the way out. PARKING LIGHTS come on as the same knob is pulled halfway out. INSTRUMENT PANEL LIGHTS are on in both positions. Instrument panel lights can be increased or decreased in intensity, or turned off, by rotating the control knob. Rotating it completely counterclockwise turns on courtesy lights.

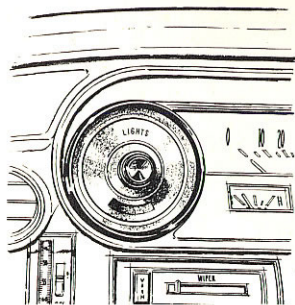

Headlight dimmer switch

The headlight dimmer switch permits you to select the correct headlight beam for different types of driving. All four lights are on when you use the high beam for highway driving . . . only the upper lights (outer lights on Seventy-Five's) are on for low beam city driving. Select desired beam by depressing the switch located on the floor just below the parking brake pedal.

INSTRUMENT PANEL AND CONTROLS

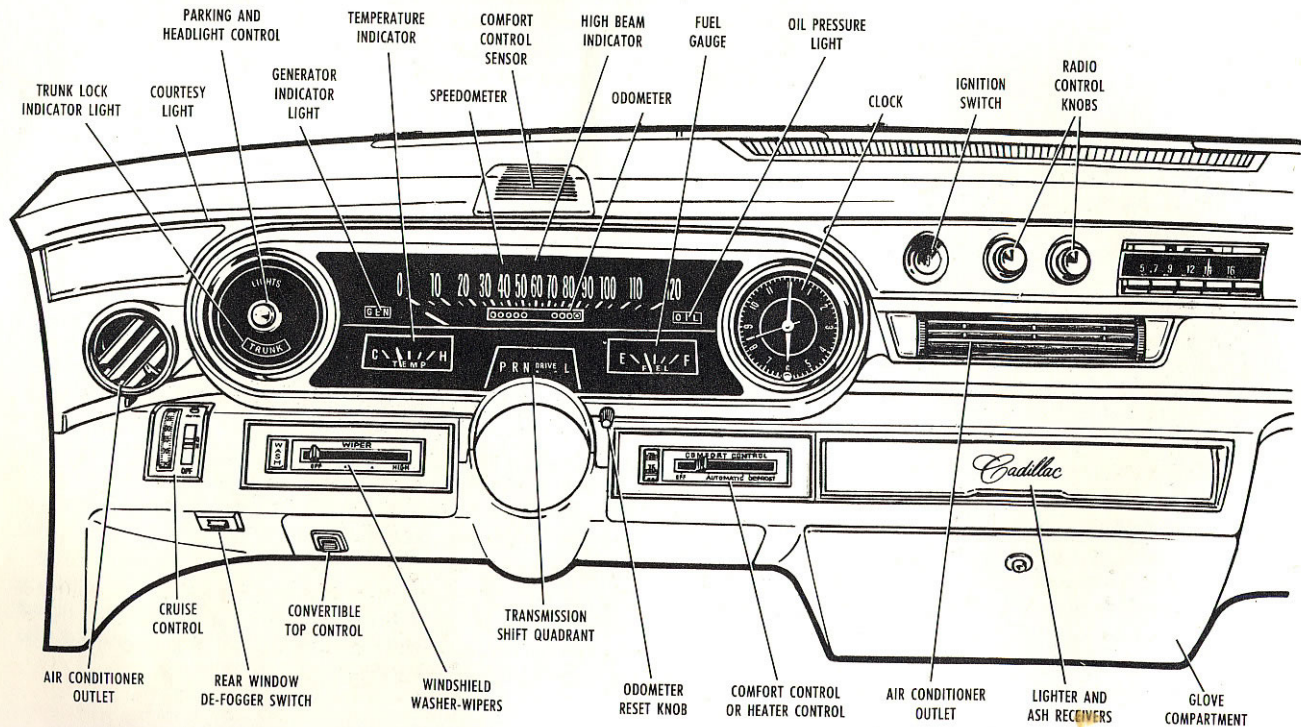

High beam indicator

When the headlights are on high beam, an indicator light above the 60 MPH mark in the instrument cluster glows red. Never leave the high beam on when approaching oncoming traffic.

Courtesy lights

Your Cadillac is equipped with courtesy lights that illuminate the interior of the car when any door is opened. When all doors are closed, full counterclockwise position of the headlight control knob turns on courtesy lights. A manual switch is centrally located on the back of the front seat divider on some sedan styles, and on the rear quarter trim panel above the left armrest on some coupe styles, for control of rear courtesy lights. On convertible styles, the manual switch is integral with the courtesy light on the front of the left rear armrest.

Electric clock

A fully automatic electric clock is located in the instrument cluster to the right of the speedometer. To reset, pull out the reset knob firmly and rotate in the direction you want to move the minute hand, until the hands register the correct time. Resetting the clock 5 or more minutes in either direction will automatically regulate the clock to run approximately 20 seconds faster or slower per day, depending on which way the reset knob is rotated. If

more than a 20-second adjustment is desired, you can reset it after 12 hours have elapsed and thereby adjust it to run an additional 20 seconds faster or slower.

To assure accurate time-keeping, your clock should be removed for cleaning and oiling every two years by your Cadillac Dealer, who will be pleased to send it to an authorized clock repair station for necessary maintenance at reasonable cost.

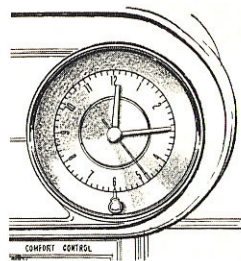

Ash receivers and lighters

There is an illuminated dual ash receiver and a lighter located in the center of the instrument panel for the convenience of both passenger and driver. The ash receiver door can be opened by pushing on the cover tab and can be closed by pulling rearward on the cover tab.

Rear combination ash receivers and lighters are provided on all models except the Calais Coupe, which is equipped with ash receivers only.

Back-up lights

For safety and convenience, your Cadillac is equipped with dual back-up lights that go on automatically when the transmission selector lever is in the "Reverse" position with the ignition switch on.

Turn signal

The turn signal lever is mounted on the left side of the steering column. The turn signal lever should be moved to the "up" position to signal for a right turn and to the "down" position for a left turn. This activates flashing signals on the right or left, both front and rear of the car, to inform oncoming and following drivers of the direction you intend to turn. Corresponding right and left signal indicator lights are located facing rearward on top of each front fender crown molding. A steady beam from either indicator light means failure of a front or rear signal bulb. For safety, and to comply with the law, have burned out bulbs replaced at once.

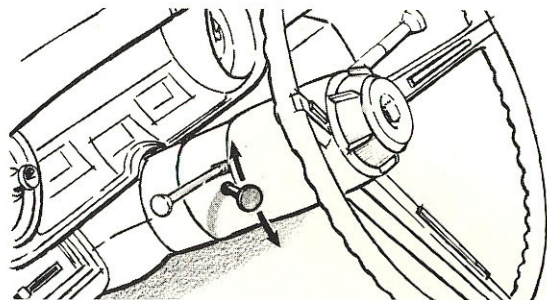

Cornering lights

Your Cadillac is equipped with cornering lights that operate in conjunction with the turn signals. When the turn signal is operating in either direction with headlights or parking lights on, the corresponding cornering light emits a steady sideward beam to provide additional illumination when turning corners.

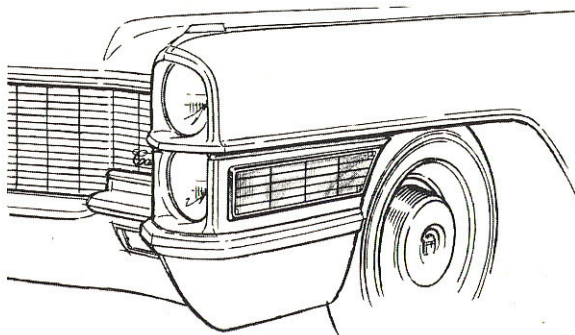

MIRRORS

Glare-proof inside rear-view mirror

The Cadillac glare-proof inside rear-view mirror is moved from clear daylight visibility to non-glare visibility at night by rotating the small tab at the bottom of the mirror. The mirror can be moved to accommodate the driver's height and seat position by moving the pivoted ball stud up or down.

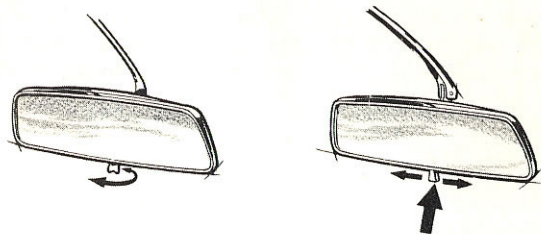

Fleetwood inside rear-view mirror

The Fleetwood Sixty Special and Eldorado Convertible 3-Way inside rear-view mirror has an adjustment for three differing types of driving. For daylight driving the lever at the bottom of the mirror should be in the left hand position. For normal night driving the lever should be positioned at the center of the bottom of the mirror. Move the lever to the right to counteract intense glare.

Remote-control outside mirror

Your Cadillac is equipped with a remote-control outside rear-view mirror. Movement of the handle, inside the car, allows you to adjust the mirror to suit your requirements. Additional rotational adjustment is possible by rotating the mirror head in its support.

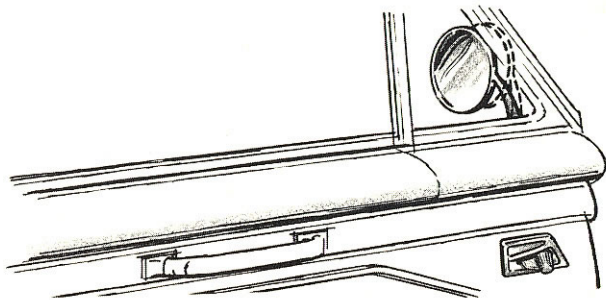

VENTILATION AND HEATING

Ventilation

On cars not equipped with Comfort Control, outside air is drawn into the passenger compartment through the grille located in the cowl directly below, and in front of, the windshield. This location minimizes intake of exhaust fumes from other cars. Ventilation controls are located in a panel above the glove box. Moving the control levers individually, right or left, away from the "OFF" position, opens air doors and admits ventilating air. The levers can be moved gradually to admit as much air as you desire.

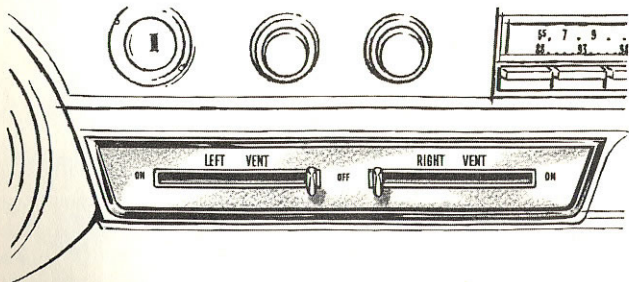

Heating

The Cadillac Heating System delivers heated air through a unit located on the right-hand side of the cowl. Outside air is delivered through the heating system to the front passenger compartment by means of grilles and openings in front of the dash panel. Heated air is delivered to the rear passenger compartment through ducts that extend under the front seat. Part or all of the heated air can be delivered to the windshield for removing fog or ice.

Heater control operation

The heater controls are located in the instrument panel to the right of the steering column (left, on Fleetwood Seventy-Five). The controls consist of a switch to control fan speed and two horizontal sliding levers to control the defroster and heater. The controls are illuminated when instrument panel lights are on.

The system can be operated with the fan switch "OFF", or with the fan running at any one of three speeds.

The lower lever controls the temperature. To increase the temperature, move the lever to the right; to decrease the temperature, move it to the left. The upper lever turns the heater on and off, and controls the quantity of defrosting air delivered to the windshield. Moving the upper lever to "HEAT" turns the heater on. If

air is desired on the windshield, move the lever to the "DE-FOG" position, and move the lower lever to the desired temperature position. For removing ice, move both levers to the extreme right, "DE-ICE" position, and move the fan switch to "HIGH".

Heater control during warm-up

For maximum heat and quickest warm-up in cold weather, place the upper lever at "HEAT", move the lower lever all the way to the right, and set the fan switch on "HIGH". If it is necessary to remove some fog during this period, move upper lever to "DE-FOG" to direct air to the windshield. Any snow covering the cowl air intake grille should be removed to facilitate defogging. It will be most

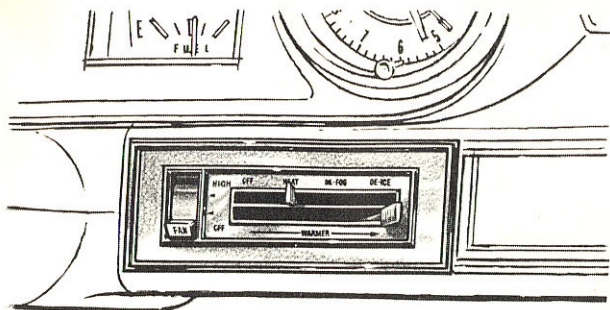

comfortable in extremely cold weather to place the upper lever in the "DE-FOG" position.



OTHER FEATURES

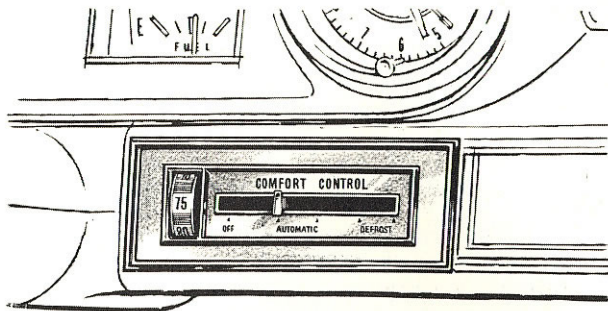

COMFORT CONTROL AIR CONDITIONER

The Cadillac Comfort Control Air Conditioner system (optional at extra cost) automatically controls the Air Conditioner-Heater system to provide the interior temperature selected by the driver on the control panel temperature dial.

Comfort Control is a completely automatic system that requires no change of setting due to outside weather conditions.

In warm weather, cooled, dehumidified air is discharged from three adjustable outlets—one at each end and one in the center of the instrument panel. In cool weather, warm air (as high as 90°F.) may be emitted from the three outlets. Each outlet can be rotated to direct air throughout the car. The end outlets can be closed off by turning the knob beneath each outlet. The center outlet can be closed off by rotating the thumb wheel.

In cold weather, heated air enters the passenger compartment through the heat distributor to the front and rear floor areas.

SECTION

2

CONTROLS

The control panel for "Comfort Control" is located just below the instrument cluster to the right of the steering column.

Normal operation

1. Set the temperature dial on the control panel to the interior temperature desired.
2. The horizontal sliding lever should be positioned at the white triangle above the word "AUTOMATIC". This turns the system on and provides 100% outside air at all times.

NOTE: After initial settings are made, it is not necessary to turn the system "OFF". The air conditioner-heater system will operate automatically whenever the car is started; it will start almost immediately in warm weather, but heater operation in cold weather will be delayed until heat is available from the engine coolant.

Unusual operation

Three additional settings of the control lever are provided for use in those few instances when extreme weather conditions call for extra volumes of heated or cooled air or for air to be directed to the windshield.

The setting marked by a red triangle above the word

"AUTOMATIC" causes the system to operate similar to the white triangle setting but at maximum blower speed, resulting in quicker cool-down in summer and warm-up in winter, and allows the air conditioner to operate on 80% recirculated air for maximum cooling efficiency.

NOTE: To achieve quicker cool-down when the car has been parked in the hot sun, it is recommended that the end outlets be positioned so they face outboard and upward on a 45° angle and the center outlet be positioned upward on a 20° angle. Also the rear windows should be lowered approximately two inches for a few minutes to exhaust the hot air.

The first "DEFROST" position should be used when the windshield is fogged over. This will direct a portion of the discharge air to the windshield and cause the blower to operate at a medium speed.

The second "DEFROST" position provides maximum

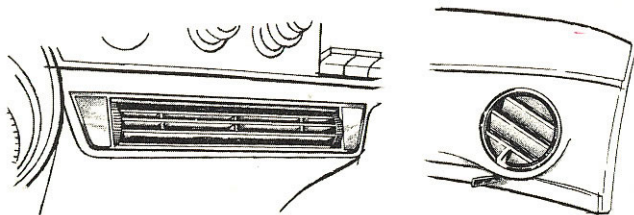

heated air at HIGH blower speed, all of which is delivered to the windshield for melting snow and ice.

REAR WINDOW DE-FOGGER

The Cadillac Rear Window De-Fogger (available from your Authorized Cadillac Dealer at extra cost) aids in keeping the rear window clear. This unit is available on all models except convertibles and Fleetwood Seventy-Five Sedans and Limousines. It is controlled by a switch on the lower side of the instrument panel to the left of the steering column. For "HIGH" fan speed, move switch to the right. For "LOW" speed, move it to the left. The De-Fogger is "OFF" when the switch is in center position.

In operation, the De-Fogger directs air against the rear window from an outlet in the rear compartment package shelf, thus keeping the rear window free of mist and fog.

TILT AND TELESCOPING STEERING WHEEL

The Tilt and Telescoping steering wheel (optional on some models at extra cost) can be tilted to any one of six different positions, and can be adjusted in and out within a 3-inch range to the most comfortable distance between you and the wheel. This permits individual selection of the most natural and comfortable position for all driving conditions. Also, on long trips, the steering wheel position

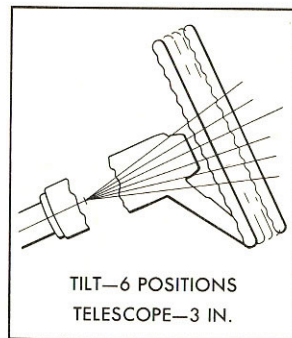
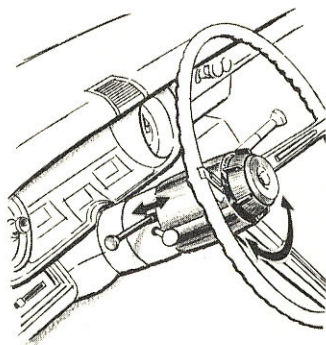

can be changed to minimize tension and fatigue. The adjustments are simple, and independent of each other.

The *tilt* mechanism is operated by lifting up the small lever on the left side of the steering column, just below the turn signal lever, moving the steering wheel to one of six angles, and releasing the lever. Telescoping of the wheel *distance* is obtained by rotating the locking ring in the center of the steering wheel counterclockwise, to unlock the mechanism, sliding the wheel into the desired position and turning the locking ring clockwise to make the adjustment secure.

Both the tilt and telescoping mechanisms can be changed while driving.

These features also permit maximum ease in entering and leaving the car. The wheel is spring-loaded, so that lifting the tilt lever automatically raises the wheel to its uppermost position. Additional clearance can be obtained by unlocking the ring and moving the wheel all the way into the column.

The Tilt and Telescoping steering wheel can be adjusted in conjunction with the seat to provide the maximum in driving comfort.

CRUISE CONTROL

Cadillac Cruise Control (optional at extra cost) is a speed reminder and automatic speed regulating device, controlled by a speed setting dial and a three-position slide switch marked "OFF", "ON", and "AUTO". In the "OFF" position, the unit has no effect on driving.

To use as a SPEED REMINDER, rotate the dial until desired speed setting, as indicated by the numerals on the dial rim, is lined up with the center of the slide switch. Then move slide switch forward to the "ON" position. Your Cruise Control indicates that the selected speed has been reached when back pressure is felt on the accelerator pedal.

Cruise Control does not interfere with normal accelerator pedal movement up to the selected speed reminder setting. To obtain further acceleration above that speed, press the accelerator pedal against the warning back pressure.

For AUTOMATIC SPEED CONTROL, move slide switch forward momentarily to the "AUTO" position; this will cause the red indicator light on top of the control panel to glow, indicating the Cruise Control is ready for automatic operation. Then rotate dial to desired speed setting. Accelerate until the

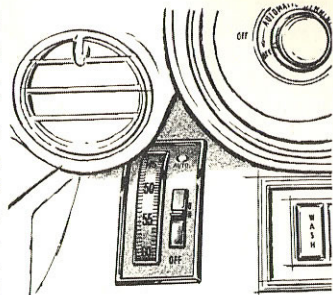

selected speed is reached and back pressure is felt on the accelerator pedal. The car will now automatically maintain the selected speed with the driver's foot off the accelerator pedal. Selected speed will be maintained, within the limits of engine performance, even when driving uphill or down.

When the unit is in automatic control, car speed can be changed by slowly rotating the dial forward to increase speed, or backward to decrease speed.

CAUTION: When changing speed during automatic control, the dial acts as a hand throttle. Always rotate dial slowly to prevent sudden acceleration.

In automatic control, car speed can be increased also by pressing the accelerator pedal against the warning back pressure.

Automatic control is disengaged when the brake pedal is depressed. To re-engage, accelerate until back pressure is again felt. The unit will again engage automatically. It is not necessary to move the slide switch to the "AUTO" position to re-engage automatic control.

The "OFF" position is provided so the slide switch may be moved rearward to disengage automatic control completely without the necessity of depressing the brake pedal. The unit is also completely disengaged whenever the ignition switch is turned off.

With the unit "OFF", no back pressure will be felt at any speed and the indicator light will not glow. When automatic control is disengaged in this manner, it is necessary to move the slide switch forward momentarily to the "AUTO" position to re-engage automatic control.

GUIDE-MATIC POWER HEADLIGHT CONTROL

The Guide-Matic Power Headlight Control (optional at extra cost) automatically switches your car's headlights from high to low beam when another vehicle approaches from the opposite direction and returns them to high beam again when conditions require it.

An override switch, integral with the headlight dimmer switch, permits the driver to hold the headlights on high beam. A sensitivity control ring located directly behind

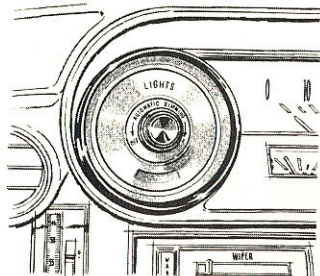

the headlight control knob, permits adjusting the sensitivity of the Power Headlight Control to suit driving conditions. This ring is identified by the words "AUTOMATIC DIMMING" above the ring. Centering the control ring pointer between "OFF" and "FAR" provides normal sensitivity. Rotating the control ring clockwise toward the word "FAR" causes the lights to dim sooner; rotating it counterclockwise delays the dimming action.

For manual operation of headlight dimming, rotate the Guide-Matic control ring counterclockwise to the "OFF" position.

NOTE: On Fleetwood Seventy-Five cars, the sensitivity control is a knob located on the rear of the phototube unit, which is mounted on the top center of the instrument panel.

TWILIGHT SENTINEL

Cadillac Twilight Sentinel (optional at extra cost) automatically turns on your car's headlights, instrument panel lights and tail lights as darkness approaches, when the

ignition switch is "ON". The unit also turns the lights off as daylight approaches.

The Twilight Sentinel control lever is located behind the headlight control knob escutcheon (on cars equipped with Guide-Matic Power Headlight Control, the control lever is located behind the sensitivity control ring.)

For automatic operation, rotate the control lever clockwise to the "ON" position and push the headlight control knob all the way in. Your car's lights will automatically turn "ON" as darkness approaches and "OFF" as daylight approaches.

A variable time delay feature permits the headlights, instrument panel lights, and tail lights to remain "ON" after the ignition switch is turned "OFF" for added convenience and safety in darkened areas. Additional side lighting can be obtained by activating a cornering light with the turn signal lever. For TIME DELAY ACTION, rotate the control lever clockwise between "ON" and "MAX" to the position that provides the desired time delay. Maximum time delay is approximately 90 seconds.

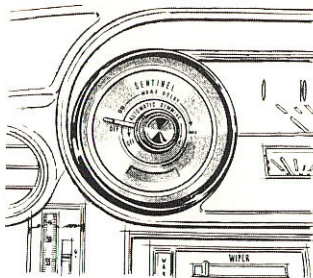

For manual operation of the headlights, rotate the control lever counterclockwise to the "OFF" position. This permits conventional operation of lights with the headlight control knob.

RADIOS

The Cadillac AM and AM-FM model radios (optional at extra cost) are both fully transistorized. The radio is located in the center of the instrument panel. Two control knobs are located to the left of the radio dial. Five push buttons are provided below the dial and a selector bar is provided above the dial.

The left control knob is the "ON", "OFF" and "VOLUME" control. The ring around the left knob controls the tone. Turned to the left, bass tones predominate—turned to the right, treble tones are accentuated.

Pushing in on the right knob raises the antenna; pull-

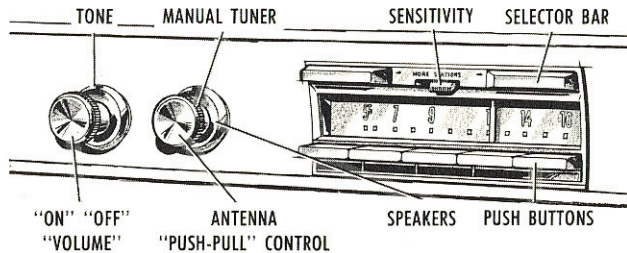

ing out lowers the antenna. The ring around the right knob controls the operation of the front and rear speakers. Counterclockwise rotation accentuates the rear speaker. Clockwise movement accentuates the front speaker. Balanced sound can be obtained by centralizing the ring.

Manual tuning of either set is accomplished by turning the right control knob to set the pointer at the desired frequency on the dial.

The five push buttons can be pre-set to favorite stations. Tune in the desired station nearest the left end of the dial with the manual tuner knob. Fine tune until best reception is obtained. Pull the first button on the left straight out, then push the button all the way in. The first button will now select that station repeatedly. Continue this process for setting the remaining buttons on other stations.

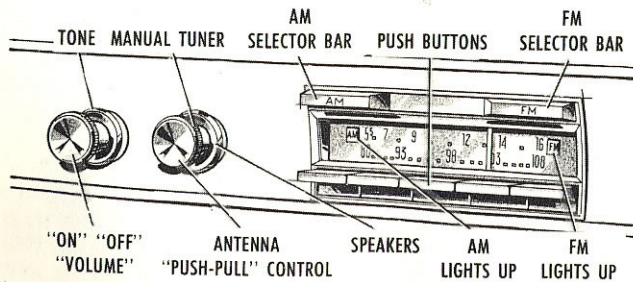

Push buttons on the AM-FM radio may be set on AM stations, FM stations, or a combination of both.

The selector bar above the dial is used on the AM-FM radio to select the desired frequency band. Pressing the left end selects the AM band and pressing the right end, the FM band. The letters "AM" or "FM" will light on the dial to show which frequency band the radio is on.

The selector bar (more stations) on the AM radio only, permits automatic search tuning. Press the bar and immediately release it to cause the tuner to change and stop at the next station on the dial. A sensitivity control for this automatic tuning is located in the center below the bar. Moving this control to the left allows the tuner to stop only on more powerful stations. In the middle position, stations of slightly lower power will be received in addition to stronger stations. To obtain maximum sensitivity, and bring in weaker stations, move control to the right.

The FM receiver is normally free from most atmospheric and man-made static. The effective range of FM transmitters, however, is usually limited to no more than line-of-sight from the transmitter—or about twenty miles. Moving out of this effective range will produce a "flutter" or a series of noise bursts in the signal. Ignition interference from adjacent vehicles may also be encountered. When it is not possible to eliminate these effects by re-tuning, try switching to a stronger FM station or to the AM band.

FRONT SEATS

Manual adjustment

The front seat can be adjusted forward or rearward. Merely move the lever forward on the driver's side of the seat and adjust to the most comfortable driving position. Then release the lever to lock the seat in this position. If you desire, the seat may be lowered by having your Authorized Cadillac Dealer remove the shims between seat supports and the floor.

Power front seat controls

The controls for electrically operated seats (optional on some models at extra cost) are mounted on the side of the seat cushion panel to the left of the driver. The seat control on the Fleetwood Seventy-Five sedan and limousine is located on the left side of the steering column lower cover.

For forward and backward adjustment of the two-way electrically controlled seat, move the switch lever in the direction of the desired seat movement.

Adjust the six-way power seat as follows: move the switch lever forward or backward to control the horizontal fore and aft movement of the seat.

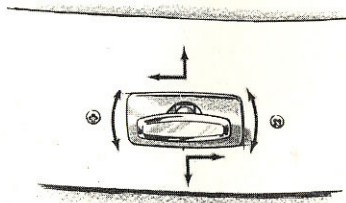

Move the switch lever up or down to control the vertical movement of the seat. Rotate the switch lever clockwise to lower and counterclockwise to raise the rear of the seat and to tilt the seat back accordingly.

Additional rearward seat positioning can be made available with all bench type seats by having your dealer reposition the seat one inch rearward at the attachment to the floor.

Bucket seats

On cars equipped with bucket seats, electrical controls are provided for fore and aft movement of the seats. The controls are located on the outboard side of the seat cushion panels.

Four-way movement of the driver's seat is provided as standard equipment only on the Fleetwood Eldorado Convertible. The four-way movement feature of the driver's seat is optional at extra cost on other cars with bucket seats.

Seat belts

Your car is equipped with two front seat belts. Rear seat belts are optional at extra cost as well as an additional front or rear seat belt for a third passenger.

The outboard webbed strap on each front seat belt is retractable for convenient storage. When buckling the belt, make certain the retractable strap is pulled all the way out of the retractor drum to provide maximum restraint.

To fasten the belt, insert the metal portion on the end

of the retractable strap into the buckle. Pull on the free end of the belt to tighten it. Tilting and pulling the buckle loosens the belt. See instructions for belt adjustment on underside of buckle. To release the buckle, depress the Cadillac Crest on the front of the buckle.

CAUTION: Proper use and care of your seat belts is important. Avoid the following unsafe conditions:

- (a) *Wearing seat belts loosely or with slack in the system.*
- (b) *More than one person per belt.*
- (c) *Bleaching or redyeing webbing. (Use mild soap and water for cleaning the nylon webbing).*

POWER WINDOWS

Master controls for the electrically operated windows (optional on some models at extra cost) are located on the left front door armrest. The control switches are positioned to correspond with the windows they control: the left front switch for the left front window, etc.

There are individual controls at each window. The control for the right front window is located on the right door armrest. Controls for the rear door windows are on the rear door armrests or trim pads.

The rear quarter windows on coupe styles are individually controlled by switches located on the rear armrests.

Window lock switch

A window lock switch is standard on all cars equipped

with power windows except the Fleetwood Seventy-Five sedan and limousine. The window lock switch is located forward of the power window switches. This switch has three positions marked "EMERG.," "LOCK," and "NORMAL."

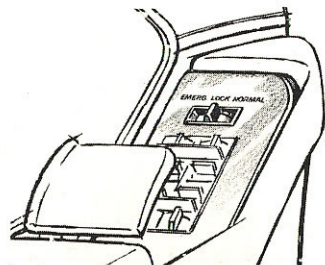

In the "NORMAL" position with the ignition "ON," all windows may be operated by the master switch or each individual switch. To prevent passengers from operating any windows, as in the case with small children in the car, place the switch in the "LOCK" position. Only the master switch will remain operative.

The "EMERG." (emergency) position permits energizing the master switches with the ignition "OFF," but only while it is held in the "EMERG." position. This will permit lowering or closing the windows without turning the ignition key "ON." All window switches, including the master switch, are inoperative in the "NORMAL" or "LOCK" position with the ignition "OFF."

Power vent windows

Electrically operated vent windows are standard on some models and optional at extra cost on other models. Control

switches for both front vent windows are located on the left armrest. There is also a switch for the right-hand vent window on the right armrest.

On the Fleetwood Sixty Special Sedan, master switches for both rear vents are located on the left front door armrest. Individual controls are on the armrests of the rear doors.

LOCKS

Manual door locks

Each door on your Cadillac can be locked from the inside by pushing down the door lock button. Doors may also be locked from the outside with this button by pushing the button down while the door is open, and then holding the door handle opening button all the way in while closing the door. As a security feature, locks on the rear doors of sedans are set so that both inside and outside door handles are inoperative when the lock button is depressed. To open a door, lift the lock button before operating the door handle.

Power door locks

If your Cadillac is equipped with power door locks (optional at extra cost) all doors can be locked or unlocked automatically from inside by operating either front door lock button. Push the button down to lock all doors, and pull the button up to unlock the doors. All doors can also

be locked or unlocked automatically from the outside by turning the key in the lock cylinder of either front door. In addition, all doors can be unlocked automatically by operating either front door inside handle.

Rear doors on sedans equipped with power door locks will not unlock or open with the inside door handle when the lock button is depressed, but can be unlocked individually by lifting the lock button.

Hood latch

The hood latch is operated in two steps by means of a lever. The release lever is accessible between the grille and hood panel, just to the right of center when viewed from

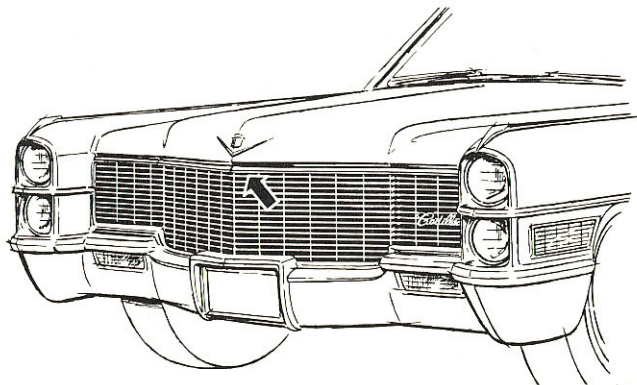

the front. Apply pressure to this lever, forcing it upward. The hood will release but will be prevented from opening further by a secondary latch. Further movement of the lever will release the secondary latch, allowing the hood to be raised. To close hood, pull hood down until it will drop of its own weight. Always check to make sure hood is properly secured.

Luggage compartment

The lid on the luggage compartment of your Cadillac is counterbalanced for easy opening. It has a key-lock release. To open, insert the key with the round head into the lock located behind the crest, turn key in a clockwise direction to release lid, then lift up on the lower edge to raise lid. An interior light goes on when lid is raised. To close, pull to a position six or eight inches from closing, remove key and push lid firmly downward. This automatically locks luggage compartment.

Power trunk lock

The power trunk lock, available on some models at extra cost, is operated by a control button located in the glove box. When the button is depressed, the trunk lid automatically unlocks and a light on the headlight switch dial face glows red, indicating that the trunk lid is unlocked. When the trunk lid is lowered, a latching mechanism pulls the lid firmly closed and locks it. In addition

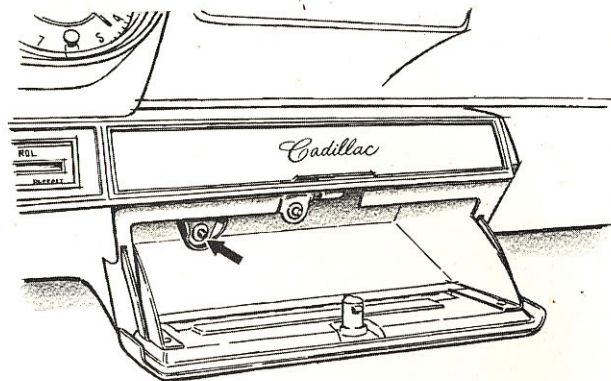

to the automatic control feature, the trunk can also be opened with a key from outside the car. To prevent damage to the closing mechanism, avoid slamming the lid when closing. Once unlocked, the lid *must* be fully opened before the pull-down and locking can be accomplished.

To help prevent thefts from the trunk; keep the glove box locked when leaving the car unattended.

AUTOMATIC LEVEL CONTROL

Automatic Level Control is standard on the Fleetwood Series, except on the Seventy-Five models, and optional

at extra cost on all other models. Automatic Level Control maintains the height of the rear of the car automatically. The leveling system responds to actual changes in load of passengers or luggage, and will compensate for loads up to 500 pounds.

CONVERTIBLE TOP

The folding top can be lowered with the rear glass window and rear quarter windows either open or closed.

To lower the top, stop the car and rotate the locking handle inboard on each side roof rail until the lock hook lever is disengaged from the striker on the windshield header.

NOTE: Do not attempt to raise top above windshield header by hand.

The power top control switch is located on the top left side of the steering column lower cover. Lift up on control switch until top is in fully lowered position.

To install top boot, place boot in position over folded top and engage boot fasteners to the studs along the body molding and on the rear quarter trim. Engage fasteners on

front of boot to studs on rear seat back panel. Press down on forward edge of boot to secure hook and pile fastener.

To raise the top, always stop the car first. Then turn down sun visors, and un-snap top boot. Press down on control switch until top is fully raised and guide studs on lock assemblies

are engaged in striker holes on windshield header. Rotate each locking handle outboard until lock hook lever is fully engaged with striker on windshield header and handle is parallel with side roof rail.

NOTE: Be sure top is securely locked to windshield header before starting car in motion.

For detailed information and instructions on the operation and care of the folding top, refer to the Convertible Top booklet in the glove compartment of all convertibles.

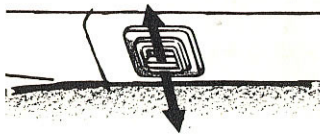
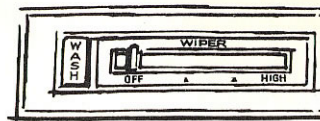



FLEETWOOD SEVENTY-FIVE SEDAN AND LIMOUSINE

GENERAL

The Cadillac Fleetwood Seventy-Five represents the finest in formal motoring. Both the Sedan and Limousine styles embody many fine features not found in other models.

An extraordinary complement of powered conveniences accent the luxury of the Fleetwood Seventy-Five. Brakes and steering, window regulators and front seats are power assisted. A remarkably smooth Turbo Hydra-matic transmission supplies an effortless flow of power. And its long 149.75 inch wheel-base and more than twenty foot over-all length provide exceptional riding comfort and spaciousness.

Additional information given here covers the operating procedures for items exclusive to Fleetwood Seventy-Five Sedans and Limousines. A complete understanding of these procedures will add to the enjoyment of your majestic 1965 Cadillac.

SECTION

3

INSTRUMENTS

The instructions on use of the ignition switch, and the various instruments, as given in Section 1, apply equally to the Seventy-Five cars, except for changes in location, as shown in the illustration of the Seventy-Five instruments and controls on the following page.

Map light

A map light is located at the center of the instrument panel under the top edge. It can be operated manually by means of the switch at the front center of the map light lens. This light also serves as an automatic courtesy light when either front door is open.

Courtesy lights

Your Cadillac is equipped with courtesy lights that illuminate the interior when any door is opened. On Limousine styles, a front compartment dome light, located in the roof above the rear-view mirror, may be turned on with the switch on the assembly. Rear compartment reading lights are provided and may be turned on with the rear light switch, located above the right rear armrest. The rear compartment lights and door courtesy lights may be turned on with the forward light switch, located above the right rear armrest.

POWER WINDOWS

Master controls for electrically operated windows are located on the left instrument panel cover extension.

Controls for the rear door windows are located in the forward portions of the rear quarter armrests. On Limousine styles, a switch is mounted on each rear armrest, in front of the window switch, to operate the partition window between the front and rear compartments.

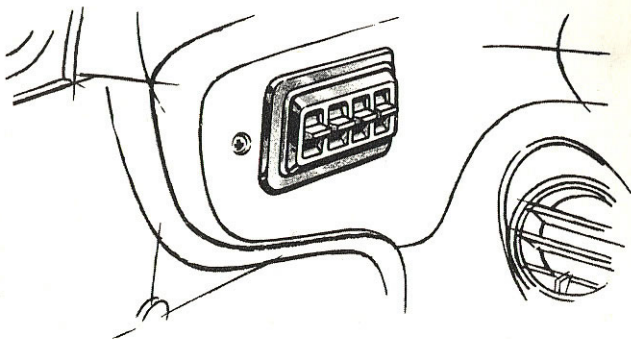

Rear vent windows

The rear vent windows may be partially opened and closed by fore and aft movement of the window knob, located above the lower garnish molding at the window.

INSTRUMENT PANEL AND CONTROLS

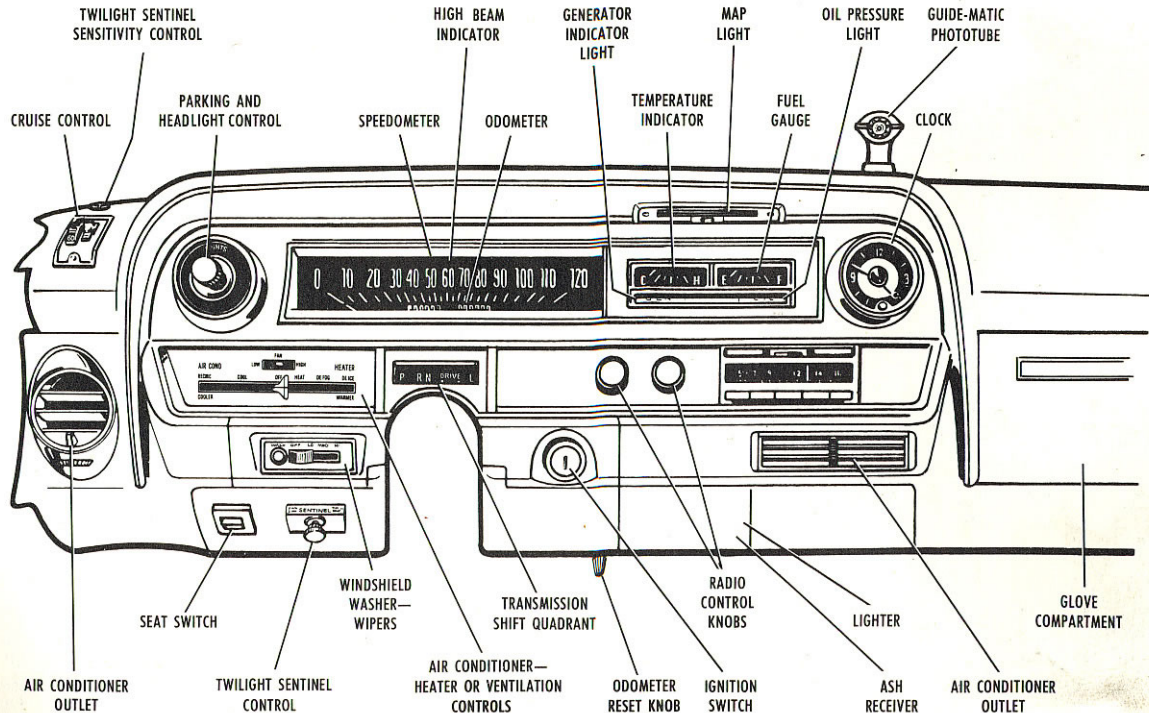

ASH RECEIVERS AND LIGHTERS

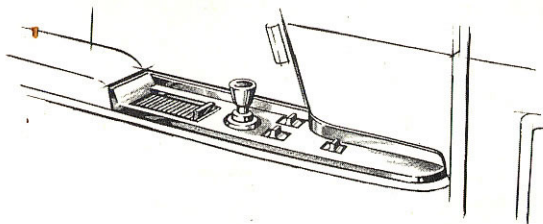

Rear ash receivers are located in the rear armrests. In addition, there are two ash receivers mounted in the center of the front seat back on either side of the rear compartment clock. A lighter is located in the left rear armrest, and also in the right rear armrest on cars without rear radio controls.

CRUISE CONTROL

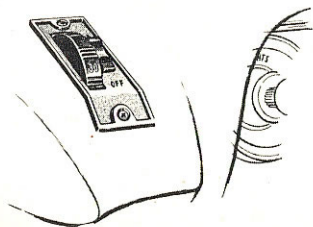

The Cadillac Cruise Control (optional at extra cost), as installed on Fleetwood Seventy-Five cars, operates in the same manner as the unit used on other 1965 Cadillacs, as described on page 19, with the following minor exceptions:

The operating controls are mounted on the left instrument panel cover extension. To use as a speed reminder, rotate the dial until the desired speed setting appears in the opening next to the word "OFF;" then move switch "ON." Adjust the dial as necessary to make the accelerator back pressure occur at the desired speed.

For automatic control, rotate dial to desired setting (if this has not already been done) and accelerate until this speed is reached and back pressure is felt at accelerator. Move lock-in switch forward while holding back-pressure; then release the switch. The car will now maintain the speed selected.

Automatic control is disengaged by depressing brake pedal or moving switch to "OFF" position. To re-engage, move switch to "ON" position, and repeat the above procedure.

TWILIGHT SENTINEL

Twilight Sentinel (optional at extra cost) automatically turns on your car's headlights, instrument panel lights, and tail lights as darkness approaches, when the ignition switch

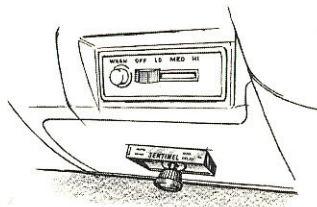

is "ON". Similarly, the unit turns the lights off as daylight approaches.

For automatic control, push in the Manual-Automatic control knob to the left of the steering column below the dash. Leave the headlight control switch in "OFF" position for automatic operation. A photo-electric cell cap located on the left instrument panel cover extension marked "EARLY" and "LATE" permits adjusting Twilight Sentinel Control sensitivity to suit driving conditions. Turning the photo-electric cell cap toward "EARLY" direction causes the lights to turn on early as darkness approaches; turning toward "LATE" causes the lights to come on later.

A variable time delay feature permits the headlights and tail lights to remain "ON" after the ignition switch is turned "OFF" for added convenience in darkened areas. Additional side lighting can be obtained by activating a cornering light with the turn signal lever. For time delay action, rotate the control knob clockwise to the position that provides the desired time delay. (Manual-Automatic control knob must be pushed in.) Maximum time delay action is approximately 90 seconds.

For manual operation of the headlights, pull out on the Twilight Sentinel knob, as indicated on the chrome bezel. This permits conventional operation of lights with the headlight control knob.

REAR HEATER CONTROLS

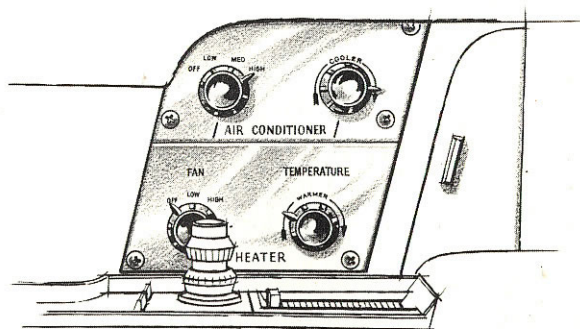

The heater control panel for the rear compartment heating system is located behind a sliding door above the right rear armrest. The controls consist of a fan switch to regulate fan speed and a temperature knob to control rear compartment temperatures. The fan switch turns the rear heaters on and off. It also controls the amount of air being discharged through the rear heaters and may be operated on either of two speeds—"LOW" or "HIGH". To increase the temperature, rotate the temperature knob clockwise in the direction of the arrow; to reduce the temperature, rotate the knob counterclockwise.

AIR CONDITIONING SYSTEM

The Cadillac Fleetwood Seventy-Five air conditioning system is designed to provide cool, dehumidified air to lower the temperature of the car interior to a comfortable level. The front compartment cooling unit is located on the right cowl and delivers air into the front passenger compartment.

A separate cooling unit is mounted in the trunk compartment. This unit delivers cooled air to rear seat passengers through two outlets mounted in the roof.

AIR CONDITIONER CONTROLS

The air conditioner control panel for the front compartment is located in the instrument panel to the left of the steering column. A switch on the upper center of the control panel regulates blower speed. There are two horizontal sliding levers. The upper lever controls the air flow for the operation of the air conditioning, heating and defrosting systems. The lower lever controls the air temperature.

Moving the upper lever to the "COOL" position turns the system on and provides cooled outside air. For maximum cooling efficiency on hot or humid days, advance the upper lever to the "RECIRC" position. In this position, a small amount of outside air is mixed with the recirculated air. Moving the lower lever to the left reduces air temperature; moving it to the right increases air temperature.

For maximum cooling, move the lower horizontal sliding lever to the extreme-left-hand position, turn the blower on "HIGH", and slide the upper lever to "RECIRC." If the weather is not too humid, it is recommended that the upper lever be maintained in the "COOL" position at all times. This will assure fresher air under most conditions and will reduce the accumulation of objectionable odors. If the air becomes too cool, turn the blower to a lower speed, or move the lower sliding lever to the right.

Separate rear controls are located above the heater controls behind a sliding panel, just above the rear right-hand armrest. The unit may be turned on and off and air volume may be controlled by the switch. To reduce the temperature, rotate the temperature knob clockwise; to increase the temperature, rotate the knob counterclockwise.

The two rear outlets located in the rear roof are equipped with a number of small openings for providing diffused cooled air. Each outlet is equipped with a door that may be opened to direct air toward the rear passengers.

REAR COMPARTMENT RADIO CONTROLS

A rear seat radio remote control is optional at extra cost on cars equipped with a signal seeking selector radio. It is mounted in the right rear armrest and consists of an on-off volume control, a sensitivity control and a station selector button.

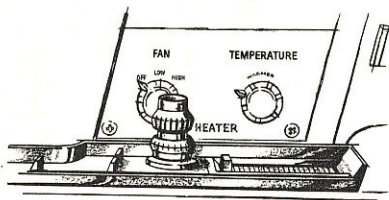

With the rear seat radio switch on, only the rear controls operate the radio. The radio cannot be operated normally from the front seat again until the rear control is turned off.

The on-off volume control knob turns the radio on and off and regulates the volume. When the rear seat radio remote control is on, the station selector button glows red. The sensitivity control is below the on-off knob. Rotating it counterclockwise will permit the tuner to stop only on the more powerful stations. In the middle position, stations of slightly lower power will also be received. For maximum sensitivity, rotate the control clockwise to bring in the weaker stations. To select stations, momentarily depress the station selector button located between the rear door window control switches.

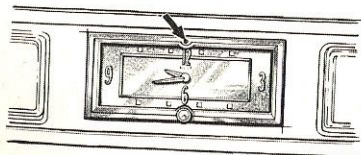

ELECTRIC CLOCKS

Two electric clocks are provided, one on the right side of the

instrument cluster, the other in the center of the front seat back. The rear clock may be manually regulated by turning the small regulator screw clockwise to make the clock run faster and counterclockwise to make it run slower.

For explanation of the front clock resetting procedure, refer to item on "Electric Clocks" on page 11.

HOOD LATCH

The hood latch is operated in two steps by means of a lever and a separate secondary latch. The release lever is accessible beneath the center horizontal grille bar just to the left of center when viewed from the front. Apply pressure to this lever, forcing it to the right. The hood will be released but prevented from opening by the secondary latch. Reach in at the hood opening at the center and

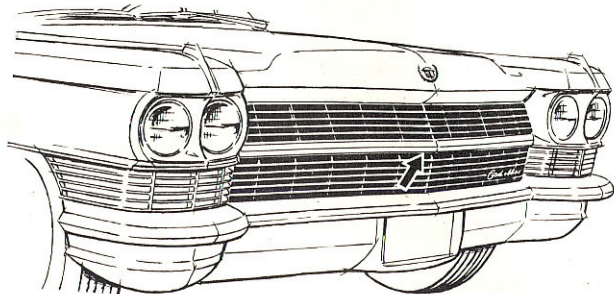

force the secondary latch upward to the limit of its travel. Hold in this position and raise the hood. To close the hood, pull it down until it drops of its own weight. Always check to make sure the hood is properly secured.

EMERGENCY WHEEL CHANGING INSTRUCTIONS

The jack components are stowed in the luggage compartment. The jack and jack handle are in a carton and the wheel wrench is stowed beneath the spare tire.

CAUTION: On cars equipped with a Controlled Differential, do not jack one rear wheel off ground with the engine running.

1. If at all possible, have the car on level ground off the highway.
2. Remove jack components and spare tire from luggage compartment.
3. Place transmission lever in PARK position, set the parking brake and **BLOCK THE WHEEL DIAGONALLY OPPOSITE THE FLAT TIRE.**
4. Locate the jack under the sill near the door openings, front or rear, in either of the positions indicated in the drawing. (When lifting the rear of a Commercial Chassis, position the jack in the same location under the frame side rail.)
5. Raise car until tire is just touching the ground, re-

move front wheel disc or wheel shield and rear disc. Use thin tip of jack handle to remove wheel disc. To remove rear wheel shield, turn the locking rod tab, located at center of the lower edge of the shield. Place jack handle on locking rod tab (handle pointing rearward on left side or forward on right side), then rotate handle outward to loosen locking rod. Tip shield outward at the top while raising up and away from the mounting hooks.

6. Loosen wheel nuts a half turn (counterclockwise).

7. Raise car until wheel is off the ground, remove mounting nuts and lift wheel off hub.

8. Reverse procedure to install wheel. Make certain wheel mounting nuts are tightened securely. Use rubber covered portion of jack handle to install wheel disc.

CAUTION: The jack supplied is intended for use only on this vehicle and only for wheel changing purposes.

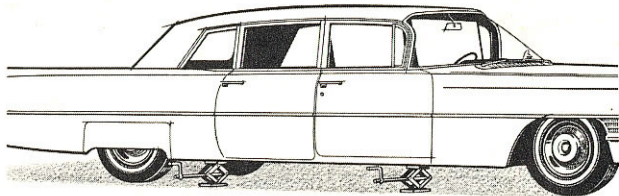



SERVICE FOR YOUR CAR

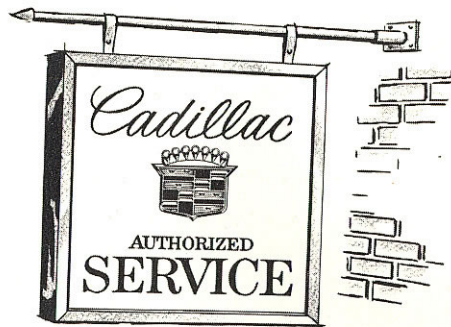

AUTHORIZED CADILLAC SERVICE

Warranty

When purchased new, your Cadillac is covered by the Manufacturer's New Vehicle Warranty and the Policy on Cadillac Owner Service, both of which are explained in your Owner Protection Plan booklet given to you by your Authorized Cadillac Dealer at the time of delivery.

Basically, the manufacturer warrants the car, with the exception of the battery, tires, and normal maintenance items, for a period of 24 months or 24,000 miles, whichever occurs first, from the date of delivery to the original owner by an Authorized Cadillac Dealer. This warranty applies to the replacement of parts not necessitated by accident, abuse, or lack of recommended maintenance as explained in the Owner Protection Plan booklet.

SECTION

4

Required adjustments are normally made by your Authorized Dealer during the new car preparation operations. Any required service adjustments that do not involve the replacement of a part will also be made at no extra charge by any Authorized Cadillac Dealer for a period of 90 days, or 4,000 miles. After that period, service adjustments are chargeable as maintenance.

Protect-O-Plate

The Protect-O-Plate on the inside back cover of your Owner Protection Plan booklet contains identification data pertaining to your new Cadillac. A second plate, containing your name and address and delivery information will be mailed to you. Please attach this second plate in the space provided just as soon as it arrives.

• This combination of plates, properly placed in your Owner Protection Plan booklet, will speed up the writing of repair orders when you bring your car in for service. It will also provide all needed identification data should warranty work be required.

Owner responsibility

Your new Cadillac, like all fine machinery, requires regular care to maintain its peak performance and preserve its showroom appearance. Periodic maintenance assures you of many miles of carefree driving, and protects your investment. A recommended maintenance schedule is in-

cluded in the Owner Protection Plan booklet.

Cadillac service

Authorized Cadillac Dealers are well qualified to assist you in the maintenance of your car because their service personnel have the advantages of:

1. Specialized Cadillac training at General Motors Training Centers.
2. Special tools and equipment designed for Cadillac products.
3. Genuine parts that are engineered for your Cadillac.
4. Factory product information and factory-dealer cooperation that contribute to efficient service and the latest in mechanical procedures.

For the best in Cadillac Guardian Maintenance service, take your Cadillac to an Authorized Cadillac Dealer.

FUEL

The best fuel for your Cadillac

The 1965 Cadillac engine requires a fuel with an octane rating of at least 100 Research Method and 89 Motor Method at sea level. Use of low octane fuels will result in severe engine knock, with possible damage to major engine parts.

Engine detonation—known as spark knock or “pinging”—generally indicates the fuel’s octane rating is below engine requirements. If “pinging” persists, even when the

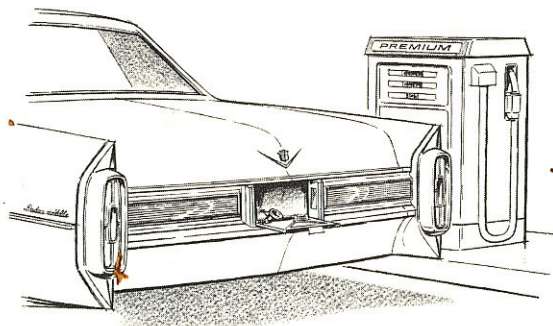

best available fuel is being used, see your Authorized Cadillac Dealer.

The manufacturer regards engine damage caused by use of fuels of insufficient octane as engine misuse, for which the manufacturer is not responsible under the terms of the manufacturer's New Vehicle Warranty. Always specify a gasoline that will meet engine requirements.

Do not be alarmed if the car loses power at fairly high altitudes. This is normal with reduced air density.

Warning **on operation in foreign countries**

IF YOU PLAN TO OPERATE YOUR CADILLAC IN MEXICO, OR OTHER FOREIGN COUNTRIES,

WITH THE EXCEPTION OF CANADA, YOU MAY FIND AVAILABLE FUELS SO LOW IN OCTANE THAT EXCESSIVE KNOCKING AND SERIOUS ENGINE DAMAGE RESULT FROM THEIR USE. TO MINIMIZE THIS POSSIBILITY, MAKE CERTAIN THAT FUELS OF SUFFICIENT OCTANE VALUE ARE AVAILABLE. BEFORE TAKING YOUR CADILLAC OUTSIDE THE UNITED STATES OR CANADA, WRITE TO CUSTOMER SERVICES SECTION, SERVICE DEPARTMENT, CADILLAC MOTOR CAR DIVISION, DETROIT, MICHIGAN 48232, GIVING:

1. your car's Vehicle Identification Number (located on the white plastic tag on the left front door lock pillar).
2. the countries in which you plan to travel.

You will be furnished details of adjustments or alterations which should be made to the engine by your Authorized Cadillac Dealer before your departure. Failure to make the necessary changes, and subsequent operation under conditions of continuous or excessive knocking, constitute misuse of engine for which manufacturer is not responsible under terms of the manufacturer's New Vehicle Warranty.

After arriving in a foreign country, contact the nearest Authorized General Motors Dealer for brand names of the best fuels available and for advice as to where they can be purchased.

Gasoline tank

Capacity of the fuel tank is twenty-six gallons on all styles except the Commercial Chassis which has a twenty gallon capacity fuel tank. The gasoline filler cap is located behind the rear license plate. Pull out on the top of the plate to open.

Positive crankcase ventilator

There are two types of Positive Crankcase Ventilator systems used to reduce air pollution by recycling crankcase fumes back to the intake manifold for burning. The closed system, installed on cars shipped to the state of California, uses a non-ventilated oil filler cap, an air cleaner strainer, and an external hose and pipe between the air cleaner and the left rocker arm cover. The system installed on all other cars uses a ventilated oil filler cap equipped with a filter.

Under no circumstances should an oil filler cap from a closed system be used on other cars or serious engine damage will result.

Specific maintenance requirements must be followed to permit satisfactory operation of each system. It is extremely important that required maintenance be performed or engine damage will result and the advantages of positive crankcase ventilation will be lost.

Maintenance is required every 12,000 miles or twelve months, whichever occurs first. Consult your Authorized

Cadillac Dealer who is familiar with the proper care of these devices.

ENGINE

Your Cadillac engine requires four quarts of oil on a refill after the crankcase has been drained. One additional quart is required when the oil filter is changed. Proper oil level should always be maintained within the driving range marked on the oil dipstick. Each time you buy gasoline have the oil level checked after first allowing a few minutes for the oil to drain back into the oil pan. Add one quart when the level drops to the "ADD OIL" mark—NOT BEFORE. Do not operate the car with the oil level above the "FULL" mark.

Initial oil fill

The oil used to fill the crankcase at the factory is a high quality oil that meets General Motors Standard GM 4745-M. This factory-fill oil should be left in the engine for the normal time and mileage interval as specified in the table on page 40. During the first interval, it is particularly important to have the oil level checked each time you buy gasoline since most modern, high-compression engines require a break-in period for the oil usage to stabilize.

Engine oil recommendations

Use of the proper engine oil is your best assurance of continued reliability and performance from your Cadillac

engine. It is recommended that you use an oil which, according to the label on the can, is: (1) intended for service "MS", and (2) passes car makers' tests or meets General Motors Standard GM 4745-M. Your Authorized Cadillac Dealer will be pleased to assist you in selecting the proper oil.

Winter operation

In areas where the temperature seldom goes below zero, most 10W oils provide the desired starting characteristics. Where the temperature is frequently below zero, a 5W or 5W-20 oil is recommended.

ENGINE OIL CHANGE AND VISCOSITY RECOMMENDATIONS

The change interval shown in the following table is based on oils that meet the requirements stated under "Engine Oil Recommendations". The table will serve as a guide for selecting the proper oil change interval and the cor-

rect oil viscosity at prevailing temperatures. It is not necessary to change oil for the unseasonably cold or warm day encountered during Fall or Spring.

Anticipated Lowest Temperatures	Use SAE Viscosity Number	Change Your Oil*
Above Freezing (+32° F.)	SAE 20W SAE 10W-30	Every 60 days or 6,000 miles, whichever occurs first.
Below Freezing (+32° F.) and above 0° F.	SAE 10W SAE 10W-30	Every 60 days or 6,000 miles, whichever occurs first.
Below 0° F.	SAE 5W SAE 5W-20	Every 60 days or 6,000 miles, whichever occurs first.

*If there is danger of oil contamination by dust, water or other foreign material during very extreme driving conditions, the oil should be changed more frequently than shown in the table. Your Authorized Cadillac Dealer is well qualified to advise you.

ENGINE COOLING

Your Cadillac's cooling system has been designed to maintain efficient engine operating temperatures. Check coolant level at each engine oil change to make certain proper coolant level is maintained. The system should be checked COLD. When coolant level drops one inch below the "Fill Cold" mark on the front of the radiator below the filler cap, fill only to "Fill Cold" mark. On Fleetwood Seventy-Five models, maintain coolant level $\frac{3}{4}$ inch above cooling tubes in top of upper radiator tank. Do not overfill. Keep the system leak-free by having all connections checked regularly.

Refer to page 42 for the capacity of your car's cooling system.

Important safety note

Avoid removing the filler cap while the engine is at normal operating temperature, since hot coolant will spray out. This is a normal action for all pressure-type cooling systems. Should it become necessary to add coolant, place a cloth over cap, rotate cap toward left until first stop is reached, and allow pressure to escape. Then turn again to left to remove. Be sure cap is turned tightly when re-installed.

The temperature gauge can sometimes register "H" (Hot) under severe operating conditions. However, this is not necessarily cause for alarm unless accompanied by a

buzzing noise from the radiator cap or by loss of coolant by boiling.

CAUTION: If temperature gauge indicates above-normal temperature, make certain engine is running, or is allowed to cool down to normal temperature, before adding coolant.

If gauge continues to register above normal with coolant at correct level, have your Authorized Cadillac Dealer make a thorough check of the system.

Cooling system protection

The inhibited year-around (permanent type) engine coolant used to fill the cooling system at the factory is a high quality solution that meets General Motors Specification 1899-M. This factory-fill coolant solution is formulated to withstand two full calendar years of normal operation without draining or adding inhibitors, and provides freeze protection to -20°F .

It is the owner's responsibility to keep the freeze pro-

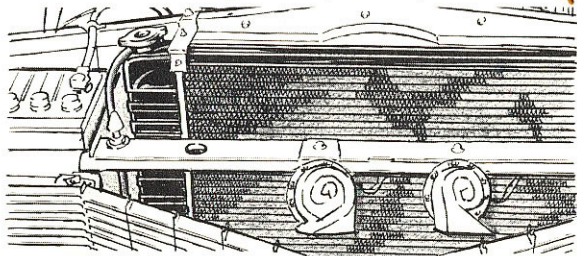

COOLING SYSTEM CAPACITY	
All cars except Fleetwood Seventy-Five with heater only	18 qt.
with Air Conditioner.....	19 qt.
Fleetwood Seventy-Five with heater only	19½ qt.
with Air Conditioner.....	20½ qt.
All Cars without heater or Air Conditioner.....	16 qt.

tection at a level commensurate with the area in which the vehicle will be operated. *Regardless of climate*, freezing protection should be maintained at least to 0°F., to provide adequate corrosion protection. When adding solution due to loss of coolant for any reason or in areas where temperatures lower than -20°F. may occur, a sufficient amount of ethylene glycol base coolant compatible to GM Specification 1899-M should be used.

Every twenty-four months, the cooling system should be serviced by flushing with plain water, then completely replacing the coolant with a fresh solution of high-quality, inhibited (permanent type) coolant meeting GM Specification 1899-M, and providing freezing protection at least to -20°F. At this time, also add GM Cooling System Inhibitor and Sealer or equivalent. In addition, Cooling System Inhibitor and Sealer should be added every fall after the car has been driven 24,000 miles. GM Cooling System

Inhibitor retards the formation of rust or scale and is compatible with aluminum components.

NOTE: Alcohol base coolants are not recommended for your Cadillac at any time.

Windshield washer solution

A proper mixture of GM Windshield Washer Anti-freeze and Gas Line De-Icer or equivalent, should be added to your windshield washer container during cold weather to retard freezing. NOTE. The washers may not operate effectively at extremely low temperatures or while traveling at high speeds.

PREVENTIVE MAINTENANCE



Preventive maintenance for your Cadillac is based on the Manufacturer's recommendations. Details are outlined in the Cadillac Owner Protection Plan booklet. Consult your dealer for additional services that may be needed due to local climatic conditions or driving habits.

Suspension

The suspension and steering linkage connections do not require periodic lubrication. Suspension connections are packed with a special long-life lubricant and normally need repacking only when damaged seals are replaced. Steering linkage pivots must be replaced when worn or loose.

Carburetor air cleaner and filter

The carburetor air cleaner should be inspected for dust leaks every Spring and Fall. Inspect more frequently if the car is operated in dusty areas. Install a new filter element if needed at time of inspection, or at least every 30,000 miles. The element should not be cleaned.

Oil filter

A full-flow type oil filter is used on the Cadillac engine. It is recommended that it be replaced every 6 months or 6,000 miles, whichever occurs first. The filter change should be performed with an oil change.

Fuel filter

The fuel filter element should be replaced at least every Spring and Fall. More frequent service is necessary under unusual operating conditions. The filter element stops small dirt particles that may cause carburetor flooding.

Transmission fluid and strainer

The bottom pan should be drained every 24,000 miles or 2 years, whichever occurs first, and new fluid added. For cars in commercial use, and those subjected to heavy city traffic during hot weather or when the engine is idled for long periods, the bottom pan should be drained every 12,000 miles.

The strainer should be replaced only after the first 24,000 miles or 2 years, whichever occurs first.

Manufacturer-recommended fluids and lubricants

TRANSMISSION AND POWER STEERING SYSTEM

Automatic transmission fluid designated "AQ-ATF", followed by three or four numerals and the suffix letter "A", or GM Automatic Transmission Fluid available from Authorized Cadillac Dealers.

BRAKE SYSTEM

SAE approved heavy-duty brake fluid or equivalent.

CONTROLLED DIFFERENTIAL

Special GM Controlled Differential Lubricant available from Authorized Cadillac Dealers.

FRONT SUSPENSION

Special lubricant used. Periodic inspection only. See your Authorized Cadillac Dealer.

HOISTS—SERVICE LIFTING EQUIPMENT

The preferred type of hoist for lifting all 1965 Cadillac cars is one that engages the front suspension and rear axle, or all four wheels. A frame contact hoist may be used on most models when certain precautions are observed. Do NOT use a frame contact hoist to raise the Fleetwood Seventy-Five sedan and limousine.

When using lifting equipment that engages the suspension on Fleetwood Seventy-Five sedans and limousines, center car over hoist so that hoist arms are adjacent to, and outboard of, support plates on front lower arms.

When using lifting equipment that engages the suspension on cars with the perimeter-type frame, the car should be centered over hoist so that hoist arms engage outboard, flattened portion of front suspension lower arms.

EMERGENCY WHEEL CHANGING INSTRUCTIONS

The jack supplied with your Cadillac is intended for use only on this vehicle and only for wheel changing purposes.

On cars with a shelf-mounted spare wheel and tire, the jack hook and rack bar are stored on the shelf in the luggage compartment just forward of the spare wheel. The jack base is stored on top of the spare wheel (secured by a through-bolt and wing nut) and the jack handle is stored under the tire.

The spare wheel and tire on convertible styles is floor-mounted and the jack components are stored on the right side of the luggage compartment.

To change wheel, proceed as follows:

CAUTION: On cars equipped with a Controlled Differential, do not jack one rear wheel off ground with engine running.

1. If it is at all possible, park car on level ground, off the highway.
2. Place transmission lever in PARK position and set parking brake.
3. Remove spare tire and jack components from luggage compartment.
4. **BLOCK THE WHEEL DIAGONALLY OPPOSITE THE FLAT TIRE.**
5. Install rack bar in jack base.

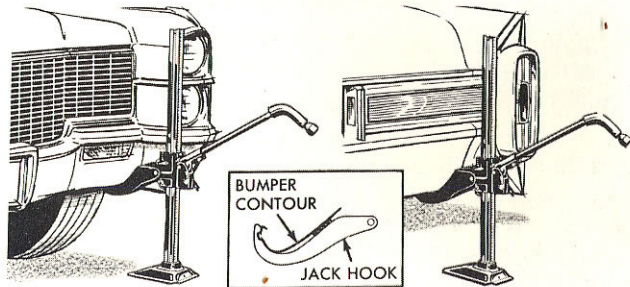

6. Engage the jack hook on the tab located behind the bumper seams (front or rear) as shown. **IMPORTANT: THE HOLE IN THE JACK HOOK MUST ENGAGE WITH THE TAB ON BACK OF BUMPER AT THE SEAM AREAS.**

7. Raise jack until snug and reposition so that rack bar is approximately vertical. (On slopes, shift the jack base in the downhill direction until the rack bar is positioned vertically or pointing slightly uphill).

8. Remove front wheel disc or rear wheel shield and rear disc. Use tip of jack handle to remove wheel disc. Remove rear wheel shield by turning the locking rod tab located on center lower edge of shield. Place jack handle on locking rod tab (handle pointing rearward on left side or forward on right side), then rotate handle outward to loosen locking rod. Tip shield outward at the top while raising up and away from the mounting hooks.

9. Loosen wheel nuts $\frac{1}{2}$ turn (counterclockwise).

10. Jack car until tire is off ground, remove mounting nuts and lift wheel off hub.

11. Reverse procedure to install wheel. Make certain wheel mounting nuts are tightened securely. Use rubber covered portion of jack handle to install wheel disc.

NOTE: For wheel changing instructions of Fleetwood Seventy-Five sedans and limousines, refer to Section 3, Page 35.

TIRES

The original equipment tires are engineered specifically for your 1965 Cadillac. When replacement is necessary, specify original equipment type tires of the correct size.

Tire maintenance

Avoid abusive treatment. Do not exceed tire loadings beyond those specified in the chart for extended periods. **MAINTAIN CORRECT INFLATION PRESSURE.**

The tire inflation pressures are for cold tires. After a long or hard drive, pressures may be as much as six pounds higher than shown in the chart.

Tire rotation

Tire rotation is not essential under normal driving conditions, but is desirable if abnormal tire wear is observed. If abnormal tire wear is evident, the condition causing such wear should be determined and corrected. The correction may include interchanging tires. Under certain driving conditions, such as fast cornering, it may be desirable to interchange tires regularly.

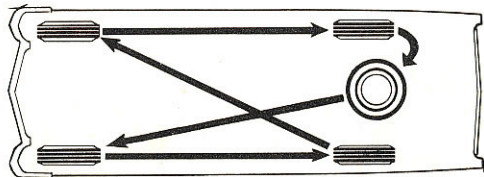

Tire pressures (when checked cold)

Tire Size	Ply Rating	Normal Load (Up to and Including)	Normal Load		*Max. Pressure Special Service	
			Front	Rear	Front	Rear
8.00 x 15—Blackwall (Except Limousines and Commercial Chassis) 9.00 x 15—Whitewall (Except Limousines and Commercial Chassis)	4	6 passengers plus 200 lbs. luggage	26	26	30	30
	4		24	24	28	28
9.00 x 15—Black or White (Except Limousines and Commercial Chassis)	6		24	24	28	28
8.20 x 15—Black or White (Fleetwood Seventy-Five Limousine only)	8	5 passengers 9 passengers plus 200 lbs. luggage	28	28	28	30
			28	34	28	38
8.90 x 15—Black or White (Commercial Chassis only)	8	Normal loading Extra equipment loading— not to exceed 7200 lbs.	24	32	—	—
			26	40	—	—

* Sustained high speeds above 80 MPH or for vehicle loadings above normal capacity

UNDERCOATING

Undercoating should not be applied to any moving or rotating part. It should be kept off air conditioner fittings and lines, body and antenna drainholes, and exhaust systems. On cars equipped with Automatic Level Control, particular care should be taken not to undercoat any fittings, lines, or system components.

APPEARANCE MAINTENANCE

Your Cadillac is finished with General Motors "Magic-Mirror" acrylic lacquer. This is a finish of maximum beauty which, in depth of color, gloss retention and durability, is

superior to conventional lacquer finishes.

Washing

The best way to preserve the finish is to keep it clean. Frequent washings are required to maintain its original beauty. Wash the car with either warm or cold (never hot) water, not in the direct rays of the sun, and not while the sheet metal surfaces are hot. Never wipe dirt from dry painted surfaces because this may scratch the finish. The use of strong soaps and chemical detergents should be avoided. All cleaning agents should be promptly flushed from the surface and not allowed to dry or they may streak the finish.

Polishing and waxing

Even though the acrylic paint on your car is more durable than conventional finishes, under certain conditions you may wish to wax or polish your car to provide maximum protection.

Calcium chloride and other salts, ice-melting agents, road oil and tar, tree sap, chemicals from factory chimneys and other foreign matter may damage any automobile finish if allowed to remain in contact with paint.

Prompt washing may not thoroughly remove these deposits and, particularly in geographical areas where these exposure conditions are severe, properly applied high quality polishes and waxes will provide the best protection. Authorized Cadillac Dealers offer both GM Magic Mirror and Blue Coral, which have proven their value in maintaining a fine finish.

NOTE: Some chemical cleaners used for removing road oil and tars from painted surfaces have been found to be detrimental to acrylic finishes. When purchasing a cleaner, make sure the instructions specifically state that the contents can be safely used on an acrylic finish.

Chrome

Many parts of your Cadillac, such as the bumpers and body hardware, are chrome plated. Chromium plating is susceptible to the actions of solutions being used on streets and highways to melt ice. Corrosive damage may also be

caused by salt air near coastlines, industrial smoke and other conditions found in urban areas. When such conditions exist, frequent washing and waxing are necessary. GM Chrome Cleaner is an excellent material for cleaning the chrome on your car.

Anodized aluminum parts

Caustic cleaning agents will discolor anodized aluminum parts such as the grille and exterior trim. Do not permit the use of steam or cleaning solutions containing these agents for the cleaning of your car.

Glass

Dirt and insects can be removed from glass with clear water. Never wipe glass with dry paper or cloth. Do not operate windshield wipers when glass is dry. Periodic inspection and replacement of wiper blades reduce the possibility of glass becoming scratched and assure clear vision under adverse driving conditions.

Care should be taken when cleaning a tinted back window. The use of harsh abrasives to clean the inside surface should be avoided, as some of the tinting material may be removed. Use a mild liquid household cleaner and remove with a soft cotton cloth.

Leather

Cadillac upholstery leathers are made from select hides and are protected by a special finish. They can be kept

clean normally by regular dusting. Leather that has become soiled can be cleaned with GM Vinyl Cleaner or thick, sudsy lather made from mild soap in lukewarm water. Avoid the use of excessive amounts of water. Remove the suds with a clean, damp cloth and wipe dry. If a sheen is desired, buff with clean cheesecloth. A high quality, glycerine base saddle soap can be used, if desired.

To remove stains such as food, pet accidents and ink, clean as previously explained. For acids and perspiration stains, use cloth dipped in solution of one teaspoon of baking soda to one cup of water, and follow up with the soap and water treatment. In the event of blood stains, wipe off with cold water before using soap and water.

Do NOT use naphtha, alcohol cleaners, household cleansing and bleaching agents, wax, polish, or oils.

White sidewall tires

GM White Sidewall Tire Cleaner is recommended. Foaming type household cleansers may also be used. Do NOT use gasoline, kerosene, or any oil product that will discolor the tire sidewalls or damage the rubber.

Upholstery and carpets

Dirt and dust in the upholstery and carpets can be removed with frequent vacuuming. GM Kar Kleen is especially recommended for cleaning carpets and upholstery, and restoring them to like-new condition. GM Fabric Cleaner can be used on spots that are difficult to remove.

Fabric roof cover

A natural rubber eraser will remove most soil spots from the fabric top. To wash the top, use lukewarm water and suds from a neutral soap. A cloth or soft-bristled brush is recommended for applying the solution of suds. Deeply embedded dirt can be removed with a moist cloth or sponge and a small amount of "foaming" type cleanser. All traces of the cleanser should be removed with clean water. Do NOT use volatile cleaners, naphtha, gasoline, harsh household cleaners and detergents, soaps, and bleaching agents. A stiff-bristled brush may seriously damage the fabric top.

SPECIAL NOTES

Before storing your car

If you do not plan to use your Cadillac for thirty days or longer, consult your dealer for recommended procedures that will prevent damage to the engine and chassis.

Lights

When the headlights are on high beam a light above the 60 mph mark on the speedometer glows red. Never leave the high beam on when driving behind another car or approaching an oncoming car. Have all your lights checked regularly. Your Authorized Cadillac Dealer has the modern equipment and genuine Cadillac parts to handle these services promptly.

Exhaust gases

Poisonous carbon monoxide is always present in exhaust gases, especially when any concentration of these gases is present in the air such as in a garage, in congested traffic, or when you have stopped directly behind a vehicle with its engine running. With the air intake located just below the windshield, your Cadillac provides you with maximum protection against exhaust fumes. Exhaust gases may have strong odors which normally should give warning of their presence. However, the exhaust gases from some vehicles may not be so noticeable under certain conditions, and the senses of various people react differently. Precautions should be taken to avoid exposing yourself to the effects of these fumes. These gases contain poisonous carbon monoxide which by itself is tasteless, colorless and odorless.

Controlled differential

On cars equipped with Controlled Differential, do not jack one rear wheel off ground with the engine running.

Transmission

The "L" range should be used when going up or down very steep grades. Where traffic signs call for first or second gear always shift to "L" range.

When parking on hills or steep inclines, place the shift lever in the Park "P" position to lock the rear wheels. Also apply the parking brake and turn the front wheels

toward curb. Always move the lever to Park "P" position and apply parking brake when leaving the car with engine running, such as when opening or closing the garage door, or when assisting passengers in or out.

Applying the brakes

For safer braking of the car on ice or snow, apply the brakes intermittently rather than continuously. Ask your dealer to familiarize you with the emergency provisions of the parking brake should the hydraulic assist be insufficient for any reason, and with the method of braking with both feet on the pedal if power assist is lost.

SPECIFICATIONS

Vehicle identification number

The Vehicle Identification Number is used in license and insurance applications and in general reference to the automobile. This number is located on the rear portion of the crankcase behind the intake manifold, and on top of the frame right side rail to the rear of the radiator. For the owner's convenience it also appears on the plastic service notice plate on the left front door lock pillar. ♣

Weight

Consult the dealer who sold you the car or the Motor Vehicle Commissioner of your state. Weight information on all body styles is regularly supplied to these authorities.

FLUID CAPACITIES

Fuel Tank—26 gallons, except Commercial Chassis—20 gals.

Turbo Hydra-matic transmission with strainer change,
3½ quarts

Engine Oil (Refill) 4 quarts; with filter change, 5 quarts

ENGINE SPECIFICATIONS

Type of Engine.....90°, V-8 overhead-valve

Bore and Stroke.....4.130 in. x 4.000 in.

Piston Displacement.....429 cu. in.

Cooling System—See page 42

DESCRIPTION	STYLE NUMBER	VEHICLE IDENTIFICATION NUMBER	WHEELBASE (INCHES)
Fleetwood Sixty Special Sedan..... (Fleetwood Brougham option)	68069	M5100001	133.0
Calais Hardtop Sedan.....	68239	N5100001	129.5
Calais Coupe.....	68257	G5100001	129.5
Calais Sedan.....	68269	K5100001	129.5
Hardtop Sedan de Ville.....	68339	B5100001	129.5
Coupe de Ville.....	68357	J5100001	129.5
De Ville Convertible.....	68367	F5100001	129.5
Sedan de Ville.....	68369	L5100001	129.5
Fleetwood Eldorado Convertible.....	68467	E5100001	129.5
Fleetwood Seventy-Five Sedan.....	69723	R5100001	149.8
Fleetwood Seventy-Five Limousine.....	69733	S5100001	149.8
Commercial Chassis.....	69890	Z5100001	156.0

FUSES AND BULBS

Fuses and circuit breakers protect the electrical wiring in the car against overloading. All fuses are contained in a fuse panel located beneath the instrument panel to left of the steering column except the Guide-Matic fuse which is located in the amplifier harness next to the amplifier. The generator indicator light fuse on Fleetwood Seventy-Five cars is located on the dustshield near the generator, and the Cruise Control fuse is located in the harness near the brake pedal switch.

Specifications for fuses and bulbs are listed in two charts. Replacement parts should be of same type and capacity characteristics as those listed.

FUSES

UNIT	FUSE SIZE	UNIT	FUSE SIZE
Accessories.....	25 Amp.	Horn.....	25 Amp.
Cruise Control (Except Fleetwood Seventy-Five)		On cars equipped with power windows and/or power seats, and on convertible styles, the 25 Amp. horn fuse is replaced by a 40 Amp. Circuit Breaker	
Rear Window De-Fogger Window Control Relay		Instrument and Back-Up..	9 Amp.
Air Conditioner and Heater	25 Amp.	Back-Up Lights	
Antenna.....	14 Amp.	Tell-Tale Lights and Gauges	
Body Feed.....	25 Amp.	Radio.....	7½ Amp.
Cigar Lighter		Tail and Stop.....	25 Amp.
Clock		Ash Tray Lights	
Courtesy Lights		Cornering Lights	
Glove Box Light		Ignition Switch Light	
*Map Light		Instrument Panel Lights	
*Cruise Control.....	6 Amp.	Stop Lights	
*Generator Indicator.....	6 Amp.	Tail Lights	
Guide-Matic Amplifier.....	4 Amp.	Twilight Sentinel	
Headlights and Parking		Turn Signal.....	14 Amp.
Lights.....	15 Amp. (CB)	Windshield Wipers.....	25 Amp.

*Fleetwood Seventy-Five sedan and limousine only
Amp.—Ampere (CB)—Circuit Breaker

BULBS

LOCATION	BULB No.	LOCATION	BULB No.
Ash Tray—Front.....	1445	Headlight Switch.....	1895
Back-Up Light.....	1156	Heater and Vent or A/C Control.....	1895
Clock—Instrument Panel.....	1895	High Beam Indicator.....	1445
Cornering Light—Front Fender.....	1195	Ignition Lock.....	1895
Courtesy Lights:		License Plate Light.....	67
Rear Quarter.....	90	*Map and Courtesy.....	212
*Rear Quarter.....	212	Oil Pressure Indicator.....	1895
Console.....	212	Park and Turn Signal.....	1157A
Instrument Panel.....	212	Radio Dial.....	1895
Rear Door.....	212	Radio—AM/FM Indicators.....	53X
*Rear Door.....	90	*Radio—Rear Control Indicator.....	53X
Rear Quarter Armrest/Top Well.....	212	Speedometer.....	1895
Cruise Control Dial.....	1445	Stop and Signal (Bumper).....	1157
Cruise Control (Lock-In Indicator).....	1445	*Stop, Signal and Tail (Fender).....	1157
*Dome Light.....	1004	Temperature Gauge.....	1895
*Dome Light (Chauffeur).....	90	*Transmission Shift Indicator.....	1195
Fuel Gauge.....	1895	Trunk Compartment.....	1003
*Fuel and Temperature Gauge.....	1895	Trunk Lid Indicator.....	1895
Generator Indicator.....	1895	Turn Signal Indicator.....	1445
Glove Compartment and Console.....	1895	Warning Light:	
Headlight:		Front Door.....	212
Lower.....	L4001	Rear Door.....	212
Upper.....	L4002	Windshield Wiper Switch.....	1895
Headlight:			
*Inner.....	4001		
*Outer.....	4002		

* Fleetwood Seventy-Five sedan and limousine only

INDEX

	Page		Page
Air Conditioner	33	Courtesy Lights	11, 29
Ash Receivers and Lighters	11, 31	Crankcase Ventilator	39
Authorized Cadillac Service	36	Cruise Control	19, 31
Back-up Lights	11	De-Fogger, Rear Window	18
Brake Fluid	43	Engine Cooling	41
Brakes	7, 49	Engine Specifications	50
Bulbs	52	Fabric Roof Cover, Cleaning	48
Carbon Monoxide	49	Fleetwood Seventy-Five	28
Carburetor Air Cleaner and Filter	43	Flooded Engine	3
Chrome, Cleaning	47	Fluid Capacities	50
Clock, Electric	11, 34	Fluids and Lubricants	43
Comfort Control	16	Foreign Countries, Operation In	38
Controlled Differential	6, 49	Fuel	37
Convertible Top Operation	27	Fuel Filter	43
Cooling System Protection	41	Fuel Gauge	4
Cornering Lights	12	Fuses	51

INDEX (cont'd)

	Page		Page
Gasoline Tank	39	Light Bulbs	52
Generator Indicator Light	4	Lights	9, 48
Glass, Cleaning	47	Locks, Door	25
Guide-Matic Power Headlight Control	20	Luggage Compartment	26
Headlight Control	9	Manufacturer's Warranty	36
Headlight Dimmer Switch	9	Map Light	29
Headlight High-Beam Indicator	11	Mirrors	13
Heater Controls, Rear	32	Oil, Engine	39, 40
Heater Operation	14	Oil Filter	43
Hoists	44	Oil Pressure Indicator Light	4
Hood Latch	25, 34	Operation in Foreign Countries	38
Ignition Switch	3	Owner Protection Plan	37
Instrument Panel and Controls	9, 10, 11, 30	Owner Responsibility	37
Jack, Use Of	35, 44	Polishing and Waxing	47
Keys	2	Power Steering Fluid	43
Leather, Cleaning	47	Power Windows	24
Level Control, Automatic	26	Preventive Maintenance	42

INDEX (cont'd)

	Page		Page
Protect-O-Plate	37	Tire Rotation	45
Radio Controls, Rear	33	Towing	6
Radios, AM and AM-FM	21	Transmission Fluid	43
Seat Belts	23	Trunk Lock, Power	26
Seat Controls, Front	23	Turbo Hydra-matic Transmission	5, 49
Seats	23	Turn Signal	12
Service, Cadillac	37	Twilight Sentinel	20, 31
Special Notes	48, 49	Undercoating	46
Specifications	49	Upholstery and Carpets, Cleaning	48
Speedometer	4	Vehicle Identification Number	49
Starting the Engine	3	Ventilation	14
Steering	8	Warranty	36
Steering Wheel, Tilt and Telescoping	18	Wheel Changing Instructions	35, 44
Storage, Car	48	White Sidewall Tires, Cleaning	48
Suspension	43	Window Lock Switch	24
Temperature Indicator	4	Windows, Power	24, 29
Tire Pressures	46	Windshield Washer Solution	42
Tires	45	Windshield Wipers and Washers	9

PART NUMBER 109 9105
SECOND EDITION

LITHO IN U.S.A.

